

CAHIERS DE TOPOLOGIE ET GÉOMÉTRIE DIFFÉRENTIELLE CATÉGORIQUES

RONALD BROWN

PHILIP J. HIGGINS

The equivalence of ω -groupoids and cubical T -complexes

Cahiers de topologie et géométrie différentielle catégoriques, tome
22, n° 4 (1981), p. 349-370

http://www.numdam.org/item?id=CTGDC_1981__22_4_349_0

© Andrée C. Ehresmann et les auteurs, 1981, tous droits réservés.

L'accès aux archives de la revue « Cahiers de topologie et géométrie différentielle catégoriques » implique l'accord avec les conditions générales d'utilisation (<http://www.numdam.org/conditions>). Toute utilisation commerciale ou impression systématique est constitutive d'une infraction pénale. Toute copie ou impression de ce fichier doit contenir la présente mention de copyright.

NUMDAM

Article numérisé dans le cadre du programme
Numérisation de documents anciens mathématiques

<http://www.numdam.org/>

THE EQUIVALENCE OF ω -GROUPOIDS AND CUBICAL T-COMPLEXES

by Ronald BROWN and Philip J. HIGGINS

INTRODUCTION.

The Seifert-van Kampen Theorem involves the category \mathcal{T}_{op_*} of spaces with base-point, the category $\mathcal{G}roup$ of groups and the fundamental group functor $\pi_1 : \mathcal{T}_{op_*} \rightarrow \mathcal{G}roup$; the theorem asserts that the functor π_1 preserves certain special colimits.

The generalisation of this theorem to all dimensions thus requires answers to three immediate questions, namely, what are the appropriate generalisations of the category \mathcal{T}_{op_*} , the category $\mathcal{G}roup$ and the functor π_1 ?

In [4,5], where such a generalised Seifert-van Kampen Theorem is proved, the answer given to the first question is simple: a space with base-point is replaced by a filtered space

$$X = X_0 \subset X_1 \subset \dots \subset X_n \subset \dots \subset X$$

such that each loop in X_0 is contractible in X_1 .

However, the second question has a surprisingly rich and varied answer, even embarrassingly so. The situation is summarised in the diagram

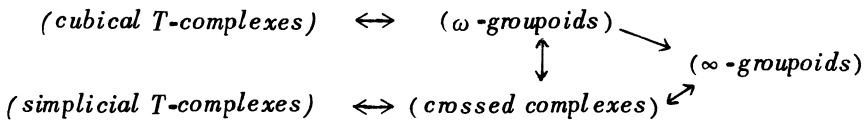

which shows the known explicit equivalences between five algebraic categories generalising the category of groups

The category of crossed complexes plays a special rôle. A homotopy functor $\pi : (\text{filtered spaces}) \rightarrow (\text{crossed complexes})$ is easily defined and is a fairly well known construction in homotopy theory (see [2, 5, 12]). This

functor replaces π_1 in one version of our generalised Seifert-van Kampen Theorem. Since colimits of crossed complexes can be completely described in terms of group presentations (see [5]), this is the natural computational form of the theorem.

By contrast, the proof of this theorem (see [3] for a sketch exposition) is carried out mainly in the category of ω -groupoids and uses in an essential way the equivalence of categories

$$(\omega\text{-groupoids}) \leftrightarrow (\text{crossed complexes})$$

and also the transition

$$\tau : (\omega\text{-groupoids}) \rightarrow (\text{cubical } T\text{-complexes}),$$

both of which were established in [4]. The object of the present paper is to show that the transition τ is part of an equivalence (in fact an isomorphism) of categories.

For the topologist, the interest of this purely algebraic result lies in its relation to some familiar ideas. The proofs in [5] use the homotopy ω -groupoid ρX of the filtered space X . Here ρX is related to the singular cubical complex KX , and the fact that ρX is also a T -complex highlights an intriguing feature of singular complexes.

It is well known that the singular complex KX of a space X is a Kan complex - a property that is usually expressed succinctly as «every box in KX has a filler». However, this property of KX is based on the existence of retractions $r: I^n \rightarrow J_{a,i}^n$, where $J_{a,i}^n$ is a box in I^n , and so is a property of the models rather than the particular space X . In particular, the fillers can be chosen simultaneously for all X so that they are natural with respect to maps of X . Further, the retraction $r: I^n \rightarrow J_{a,i}^n$ is unique up to homotopy rel $J_{a,i}^n$. This suggests the potential usefulness of Kan complexes in which boxes have *canonical fillers* satisfying suitable conditions.

Such an idea is realised in the notion of a T -complex in which certain elements are designated «thin» and are required to satisfy Keith Dakin's axioms:

T 1) Degenerate elements are thin;

T 2) Every box has a unique thin filler;

T 3) If every face but one of a thin element is thin, then so is the remaining face.

We prove here that every cubical T -complex admits the structure of an ω -groupoid; this shows that the simple axioms for a T -complex contain a wealth of algebraic information. Our proof uses a refinement of the notion of collapsing which we call *reduction*, and the methods formalise techniques implicit in Kan's fundamental paper [10].

Keith Dakin's original definition of T -complex [7] was in terms of simplicial sets, and was conceived as an abstraction of properties of the nerve of a groupoid. Nicholas Ashley proved in [1] that the category of simplicial T -complexes is also equivalent to the category of crossed complexes. (At present, this seems to be the most difficult to prove of the equivalences in the diagram above. It generalises the equivalence between simplicial Abelian groups and chain complexes proved by Dold and Kan [8, 11].) A fifth algebraic category, of ∞ -groupoids, will be defined in [6], and proved also equivalent to the category of crossed complexes. (This seems to be the easiest of the equivalences.)

Thus we have an example, possibly unique, of five equationally defined categories of (many-sorted) algebras which are non-trivially equivalent. From an algebraic point of view the equivalences provide a useful method of transferring concepts and constructions from crossed complexes, where they are easily formulated, to the other four types of structure, which are less well understood. (See, for example, [9].)

It is particularly appropriate that this paper, and its sequel [6], should appear in the Proceedings of a conference in memory of Charles Ehresmann, as he initiated the study of double and multiple categories and felt clearly that these notions should have important applications in Geometry and Algebra.

1. *T-COMPLEXES.*

Our methods involve complicated filling processes in special kinds of Kan complexes, that is, cubical complexes satisfying Kan's extension condition [10]. We adopt the following conventions.

A cubical set (= semi-cubical complex) K is a graded set $(K_n)_{n \geq 0}$ with face maps

$$\partial_i^\alpha: K_n \rightarrow K_{n-1} \quad (i = 1, 2, \dots, n; \alpha = 0, 1)$$

and degeneracy maps

$$\epsilon_j: K_{n-1} \rightarrow K_n \quad (j = 1, 2, \dots, n)$$

satisfying the usual cubical relations. But we shall also use cubical sets without degeneracies and, in particular, I^n will denote the free cubical set without degeneracies generated by a single cube c_n of dimension n . Subcomplexes A of I^n will again be without degeneracies and a (cubical) map $f: A \rightarrow K$, where K is a cubical set, will be a graded map preserving face operators. If A, B are subcomplexes of I^m, I^n , respectively, then $A \times B$ will denote the cubical set (without degeneracies) such that $(A \times B)_n$ is the disjoint union of $A_p \times B_q$ for $p + q = n$, and the face operators on $A_p \times B_q$ are given by

$$\partial_i^\alpha \times 1 \text{ for } i \leq p, \text{ and } 1 \times \partial_i^\alpha \text{ for } p < i \leq p + q.$$

Then $I^m \times I^n$ is isomorphic to I^{m+n} and we shall identify these whenever convenient.

Let $J_{a,i}^\beta$ be the subcomplex of I^n generated by all faces $\partial_j^\beta c^n$ ($\beta = 0, 1; j = 1, 2, \dots, n$) of c^n except $\partial_i^\alpha c^n$. For any cubical set K , a cubical map $b: J_{a,i}^\beta \rightarrow K$ is called a *box in K* , and an extension $f: I^n \rightarrow K$ of b is called a *filler* of the box b . Equivalently, the box b is determined by a set of $2n-1$ elements

$$x_j^\beta \text{ of } K_{n-1} \quad (\beta = 0, 1; j = 1, 2, \dots, n; (\beta, j) \neq (a, i))$$

satisfying

$$\partial_k^\gamma x_j^\beta = \partial_{j-1}^{\beta-1} x_k^\gamma \text{ for } 1 \leq k < j \leq n \text{ and } (\beta, j), (\gamma, k) \neq (a, i).$$

A filler f of b is then determined by an element $x (= f(c^n))$ of K_n sat-

isfying $\partial_j^\beta x = x_j^\beta$ for $(\beta, j) \neq (a, i)$.

The following axioms (in a simplicial context) are due to Keith Dakin [7].

DEFINITION. A *T-complex* is a cubical set K having in each dimension $n \geq 1$ a set $T_n \subset K_n$ of elements called *thin* and satisfying the axioms:

T1) Every degenerate element of K is thin;

T2) Every box in K has a unique thin filler;

T3) If t is a thin element of K and all its faces $\partial_j^\beta t$ except one are thin, then this last face is also thin.

Recall that a *Kan complex* is a cubical set in which every box has a filler. Kan showed in [10] how one can define, for such a complex K , the n -th homotopy group $\pi_n(K, x)$ for $n \geq 1$ and $x \in K_{n-1}$. We here extend his methods to show that if K is a *T-complex* then it carries the structure of an ω -groupoid as defined in [4]. We shall give the full definition of an ω -groupoid later; for the present it is enough to say that the definition requires that K admit groupoid structures $+, +, \dots, +$ in dimension n and also «connections» $\Gamma_1, \Gamma_2, \dots, \Gamma_n : K_n \rightarrow K_{n+1}$ satisfying a number of laws. Our first aim is to construct the operations $\overset{+}{j}$ and prove their basic properties.

As motivation for the construction, let $x, y \in K_1$ satisfy $\partial_1^1 x = \partial_1^0 y$, and let $e = \epsilon_1 \partial_1^1 y$. Let $t \in T_2$ be the unique thin filler of the box

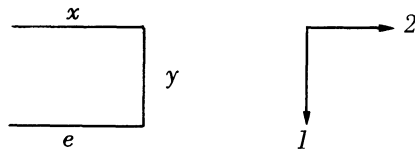

If we now define $x \overset{+}{1} y = \partial_2^0 t$, it is not hard to see that K_1 becomes a groupoid with K_0 as its set of vertices. (The proof of the associative law requires the use of thin elements in dimension 3.) The laws for $\overset{+}{1}$ are more conveniently proved if one also considers arbitrary quadruples of elements x, y, z, w of K_1 which fit together as in the diagram



and for which there is a thin element $t \in T$ with x, y, z, w as faces. (Such quadruples are, in fact, precisely those for which $x + w = z + y$.) It is this idea which we generalise to dimension n .

Let S_j^n be the subcomplex $I^{j-1} \times I^2 \times I^{n-j}$ of I^{n+1} . Thus S_j^n is generated by four cubes of dimension n , namely, $\partial_i^\alpha c^{n+1}$ for $\alpha = 0, 1$, and $i = j, j+1$. By a *socket* in a cubical set K is meant a cubical map $s: S_j^n \rightarrow K$ for some n, j . Such a socket is specified by j and four elements x, y, z, w of K_n satisfying

$$(1) \quad \partial_j^0 x = \partial_j^0 z, \quad \partial_j^1 x = \partial_j^0 w, \quad \partial_j^1 z = \partial_j^0 y, \quad \partial_j^1 w = \partial_j^1 y,$$

as expressed in the picture

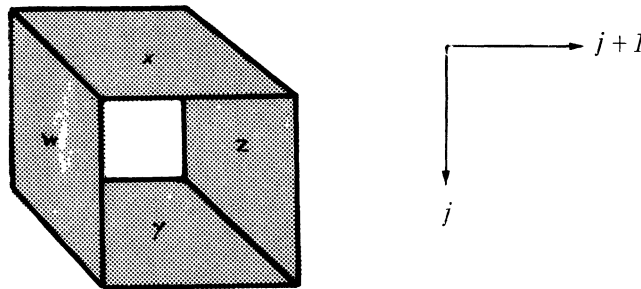

and is written $s = s_j(x, y; z, w)$. For any cubical operator ϕ (i.e., any composite of ∂_i^α 's and ϵ_j 's) we abbreviate

$$(\phi x, \phi y; \phi z, \phi w) \text{ to } \phi(x, y; z, w).$$

An element u of K_{n+1} is said to *span* the socket $s = s_j(x, y; z, w)$ (where $x, y, z, w \in K_n$ satisfy (1)) if

$$(2) \quad \partial_j^0 u = x, \quad \partial_j^1 u = y, \quad \partial_{j+1}^0 u = z, \quad \partial_{j+1}^1 u = w.$$

The cubical laws imply that in this case

$$\partial_i^\alpha u \text{ spans } \begin{cases} s_{j-1} \partial_i^\alpha(x, y; z, w) & \text{if } i < j \\ s_j \partial_{i-1}^\alpha(x, y; z, w) & \text{if } i > j+1 \end{cases}$$

and $\epsilon_i u \text{ spans } \begin{cases} s_{j+1} \epsilon_i(x, y; z, w) & \text{if } i \leq j \\ s_j \epsilon_{i-1}(x, y; z, w) & \text{if } i > j. \end{cases}$

Note also that u spans s if and only if the unique map $\hat{u}: I^{n+1} \rightarrow K$ such that $\hat{u}(c^{n+1}) = u$ is an extension of $s: S_j^n \rightarrow K$.

Let $s = s_j(x, y; z, w)$ be a socket in K_n . A plug for s is an element t of K_{n+1} such that

- (3) (i) t spans s , and
- (ii) if Δ is any cubical operator corresponding to a cube of $I^{n+1} \setminus S_j^n$, then Δt is thin.

A more intuitive way of expressing (3) (ii) is that t and all its faces, except possibly those which are x, y, z, w and their faces, are thin.

Not every socket admits a plug, but when it does the plug is unique, as we shall show. Furthermore any socket which admits a plug is uniquely determined by any three of the faces x, y, z, w . This crucial result is most easily proved by refining the notion of collapse for subcomplexes of I^n to that of «reduction» for pairs of subcomplexes. This, we do in the next section.

We note here that a cubical operator of I^{n+1} can be written uniquely in *standard form* as

$$\Delta = \partial_{i_1}^{\alpha_1} \partial_{i_2}^{\alpha_2} \dots \partial_{i_r}^{\alpha_r}$$

where

$$\alpha_k = 0 \text{ or } 1, \quad 1 \leq i_1 < i_2 < \dots < i_r \leq n+1 \text{ and } 0 \leq r \leq n+1,$$

and that Δ corresponds to a cube of $I^{n+1} \setminus S_j^n$ iff no i_k is j or $j+1$.

2. REDUCTION.

By a pair of subcomplexes of I^n we mean an ordered pair (A, B) of subcomplexes such that $A \supset B$. We say that a pair (A, B) is an *elementary reduction* of (A', B') , written $(A', B') \xrightarrow{e} (A, B)$, if there is a p -cube

x in A' ($p \geq 1$) and a $(p-1)$ -face y of x such that

$$(i) A \cup x = A', \quad A \cap x = \dot{x}$$

and (ii) $B \cup x = B', \quad B \cap x = \dot{x} \setminus \{y\}$,

where x denotes the subcomplex generated by x , and $\dot{x} = x \setminus \{x\}$. Thus for an elementary reduction, B is an elementary collapse of B' with free face y , but A «remembers» the free face.

We say that (A, B) is a reduction of (A', B') if (A, B) is obtainable from (A', B') by a finite number (possibly 0) of elementary reductions. Then B' collapses to B , while A «remembers» all the free faces of this collapsing. We write $(A', B') \searrow (A, B)$.

Before explaining the relevance of this to T -complexes, we give a crucial example.

PROPOSITION 1. *If (A', B') reduces to (A, B) , then $(A' \times I, B' \times I)$ reduces to $(A \times I, B \times I)$ and $(I \times A', I \times B')$ reduces to $(I \times A, I \times B)$.*

PROOF. It is sufficient to prove that if $(A', B') \searrow^e (A, B)$, then

$$(A' \times I, B' \times I) \searrow (A \times I, B \times I).$$

So let

$$A' = A \cup x, \quad A \cap x = \dot{x}, \quad B' = B \cup x, \quad B \cap x = \dot{x} \setminus \{y\}.$$

Then $X = (x, c^1)$ is a cube of $B' \times I$ with $Y = (y, c^1)$ as a face. If we delete X and Y from $B' \times I$ (and X from $A' \times I$) we obtain

$$(A' \times I, B' \times I) \searrow^e (A \times I \cup x \times \dot{I}, B \times I \cup x \times \dot{I}).$$

Clearly this last pair can be reduced to $(A \times I, B \times I)$ in two steps, first by deletion of $(x, 0)$ and $(y, 0)$, then by deletion of $(x, 1)$ and $(y, 1)$. \square

COROLLARY 2. *If $1 \leq j \leq n$, $a = 0, 1$, $i = 1, 2$, then*

$$(I^{n+1}, I^{n+1}) \searrow (I^{j-1} \times I^2 \times I^{n-j}, I^{j-1} \times J_{a,i}^2 \times I^{n-j}).$$

PROOF. This is immediate from Proposition 1 since $(I^2, I^2) \searrow^e (I^2, J_{a,i}^2)$.

DEFINITION. Given a pair (A, B) of subcomplexes of I^n , we say that B supports A in dimension n if, given any T -complex K and any cubical map $g: B \rightarrow K$, there is a unique extension $\bar{g}: I^n \rightarrow K$ of g whose values on $I^n \setminus A$ are all thin.

PROPOSITION 3. *If $(I^n, I^n) \setminus (A, B)$, then B supports A in dimension n .*

PROOF. Since I^n supports I^n , it is enough to show that B supports A in dimension n whenever $(A', B') \stackrel{e}{\setminus} (A, B)$ and B' supports A' in dimension n . In this case we have

$$A' = A \cup x, \quad A \cap x = \dot{x}, \quad B' = B \cup x, \quad B \cap x = \dot{x} \setminus \{y\}$$

for some cube x and face y . If $g: B \rightarrow K$ is a given cubical map, then g is defined on the box $\dot{x} \setminus \{y\}$ but not on x or on y . Any extension \bar{g} of g which takes thin values outside A must map x to a thin element and, by axiom (T2), this determines $\bar{g}(x)$ uniquely, giving a unique extension $\bar{g}: B' \rightarrow K$. Since B' supports A' , \bar{g} has a unique extension $h: I^n \rightarrow K$ which is thin outside A' . Since $h(x) = \bar{g}(x)$ is thin, h is thin outside A , as required. \square

It follows from Corollary 2 and Proposition 3 that the subcomplex S_j^n of I^{n+1} is supported in dimension $n+1$ by any of the four subcomplexes $I^{j-1} \times J_{\alpha, i}^2 \times I^{n-j}$ ($\alpha = 0, 1, i = 1, 2$). We restate this fact in terms of sockets and plugs.

PROPOSITION 4. *Let K be a T-complex and suppose that we are given any three of $x, y, z, w \in K_n$ satisfying two of the conditions (1) of Section 1 (namely the two which are meaningful). Then there is a unique fourth element such that:*

- (i) x, y, z, w form a socket $s = s_j(x, y; z, w)$,
 - and (ii) there is a plug $t = t_j(x, y; z, w)$ spanning s .
- Furthermore this plug t is uniquely determined by the three given elements.

3. THE COMPOSITIONS $\underset{j}{+}$.

The following proposition, which defines compositions $\underset{j}{+}$ in any T-complex K , is an immediate consequence of Proposition 4.

PROPOSITION 5. *Let K be a T-complex and let $x, y \in K_n$ satisfy*

$$\partial_j^1 x = \partial_j^0 y \quad \text{for some } j, \quad 1 \leq j \leq n.$$

Then there is a unique element $z = x \underset{j}{+} y$ of K_n such that

(i) there is a socket $s = s_j(x, e; z, y)$ with $e = \epsilon_j \partial_j^1 y = \epsilon_j \partial_j^1 z$, and (ii) this socket has a plug.

Further, the (partial) operation $+$ satisfies left and right cancellation laws that is, if x, y, z are related by $z = x +_j y$, then any two of x, y, z determine the third uniquely. \square

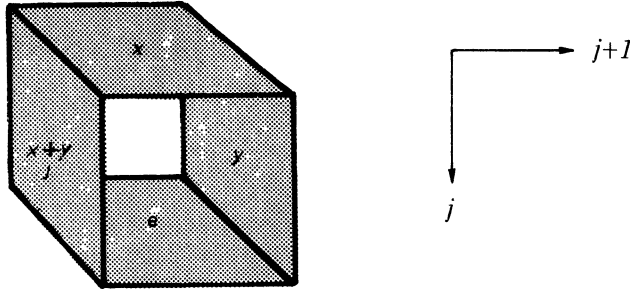

Further properties of these compositions depend on some elementary properties of plugs in K . We assume that $x, y, z, w \in K_n$.

PROPOSITION 6. If $t = t_j(x, y; z, w)$ is a plug, then $\partial_i^\alpha t$ is a plug for

$$\begin{cases} s_{j-1} \partial_i^\alpha(x, y; z, w) & \text{if } i < j \\ s_j \partial_{i-1}^\alpha(x, y; z, w) & \text{if } i > j+1. \end{cases}$$

PROOF. Certainly $\partial_i^\alpha t$ spans the given socket. Suppose that $i < j$ and $\Delta = \partial_{i_1}^{\alpha_1} \partial_{i_2}^{\alpha_2} \dots \partial_{i_r}^{\alpha_r}$ is a cubical operator in standard form corresponding to a cube of $I^{n+1} \setminus S_{j-1}^n$, so that no i_k is $j-1$ or j . Then the standard form of $\Delta \partial_i^\alpha$ contains no ∂_j^β or ∂_{j+1}^β . Hence $\Delta \partial_i^\alpha t$ is thin as required. The case $i > j+1$ is similar. \square

PROPOSITION 7. If $t = t_j(x, y; z, w)$ is a plug, then $\epsilon_i t$ is a plug for

$$\begin{cases} s_{j+1} \epsilon_i(x, y; z, w) & \text{if } i \leq j \\ s_j \epsilon_{i-1}(x, y; z, w) & \text{if } i > j+1. \end{cases}$$

PROOF. Certainly $\epsilon_i t$ spans the given socket. Suppose that $i \leq j$ and $\Delta = \partial_{i_1}^{\alpha_1} \partial_{i_2}^{\alpha_2} \dots \partial_{i_r}^{\alpha_r}$ is a cubical operator of $I^{n+2} \setminus S_{j+1}^n$ in standard form,

so that no i_k is $j+1$ or $j+2$. If no i_k is i , then $\Delta \epsilon_i$ is degenerate and therefore $\Delta \epsilon_i t$ is thin by axiom (T1). If $i_s = i$ then

$$\Delta \epsilon_i = \partial_{i_1}^{\alpha_1} \dots \partial_{i_{s-1}}^{\alpha_{s-1}} \partial_{i_{s+1}}^{\alpha_{s+1}} \dots \partial_{i_r}^{\alpha_r}$$

and since $i \leq j$ and $i_{s-1} < i < i_{s+1}$ and no i_k is $j+1$ or $j+2$, we see that $\Delta \epsilon_i$ is a cubical operator of $I^{n+1} \setminus S_j^n$. Thus $\Delta \epsilon_i t$ is thin, as required. The case $i > j+1$ is similar. (When $i = j+1$, the form of $\epsilon_i t$ is slightly different and need not concern us.) \square

Applying Propositions 6 and 7 to the definition of $\overset{+}{j}$ in Proposition 5, we obtain immediately:

PROPOSITION 8. *Let $x, y \in K_n$ satisfy $\partial_j^1 x = \partial_j^0 y$. Then*

$$\partial_j^0 (x \overset{+}{j} y) = \partial_j^0 x, \quad \partial_j^1 (x \overset{+}{j} y) = \partial_j^1 y,$$

$$\partial_i^a (x \overset{+}{j} y) = \begin{cases} \partial_i^a x \overset{+}{j-1} \partial_i^a y & \text{if } i < j \\ \partial_i^a x \overset{+}{j} \partial_i^a y & \text{if } i > j \end{cases}$$

$$\epsilon_i (x \overset{+}{j} y) = \begin{cases} \epsilon_i x \overset{+}{j+1} \epsilon_i y & \text{if } i \leq j \\ \epsilon_i x \overset{+}{j} \epsilon_i y & \text{if } i > j. \end{cases} \quad \square$$

At this stage we can also prove that $\overset{+}{j}$ has appropriate left identities.

PROPOSITION 9. *Let $y \in K_n$ and let $f = \epsilon_j \partial_j^0 y$, $e = \epsilon_j \partial_j^1 y$. Then*

$$f \overset{+}{j} y = y \quad \text{and} \quad t_j(f, e; y, y) = \epsilon_{j+1} y.$$

Also $f \overset{+}{j} f = f$ for any f of the form $f = \epsilon_j z$.

PROOF. The thin element $t = \epsilon_{j+1} y$ spans the socket $s_j(f, e; y, y)$. The faces of t in all dimensions are degenerate (and therefore thin), except those which are faces of $\partial_{j+1}^a t = y$. Therefore $t = t_j(f, e; y, y)$ and so $f \overset{+}{j} y = y$. In particular, $f \overset{+}{j} f = f$ for any element f of the form $f = \epsilon_j z$. \square

We now make our first and crucial use of axiom (T3).

PROPOSITION 10. *Composites under $\overset{+}{j}$ of thin elements are thin.*

PROOF. Let $z = x \underset{j}{+} y$ in dimension n , where x and y are thin. Let $t = t_j(x, e; z, y)$, where $e = \epsilon_j \partial_j y$. Then all the n dimensional faces of t , except possibly z , are thin. Since t is thin, axiom (T3) implies that z is thin. \square

We use this result in the next proposition, which gives rules for composing plugs and is vital for the rest of the proof.

PROPOSITION 11 (For illustrations, see the next page). (i) If

$$t = t_j(x, y; z, w), \quad t' = t_j(u, v; w, p)$$

are plugs, then $t \underset{j+1}{+} t'$ is a plug for $s = s_j(x \underset{j}{+} u, y \underset{j}{+} v; z, p)$.

(ii) If

$$t = t_j(x, y; z, w) \quad \text{and} \quad t' = t_j(y, s; q, r)$$

are plugs, then $t \underset{j}{+} t'$ is a plug for $s = s_j(x, s; z \underset{j}{+} q, w \underset{j}{+} r)$.

(iii) Let

$$t = t_j(x, y; z, w), \quad t' = t_j(x', y'; z', w')$$

be plugs and let $i \neq j$. If the four composite elements in

$$s = s_j(x \underset{i}{+} x', y \underset{i}{+} y'; z \underset{i}{+} z', w \underset{i}{+} w')$$

are defined, then s is a socket and has as plug

$$t \underset{i}{+} t' \quad (\text{if } i < j) \quad \text{or} \quad t \underset{i+1}{+} t' \quad (\text{if } i > j).$$

PROOF. (i) By Proposition 8, $t'' = t \underset{j+1}{+} t'$ spans the socket s . Also t'' is thin, by Proposition 10. Repeated applications of Proposition 8 show that for any composite Δ of face operators $\Delta t''$ has one of the forms

$$\Delta t, \Delta t' \quad \text{or} \quad \Delta t \underset{k}{+} \Delta t' \quad \text{for suitable } k;$$

so if Δ corresponds to a cube of $I^{n+1} \setminus S_j^n$ then $\Delta t''$ is thin. Hence t'' is a plug for s .

(ii), (iii): The proofs are similar. \square

PROPOSITION 12. (i) Each composition $\underset{j}{+}$ ($j = 1, 2, \dots, n$) in dimension n gives a groupoid structure on (K_n, K_{n-1}) with $\partial_j^0, \partial_j^1$ and ϵ_j as

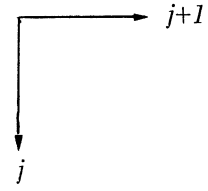
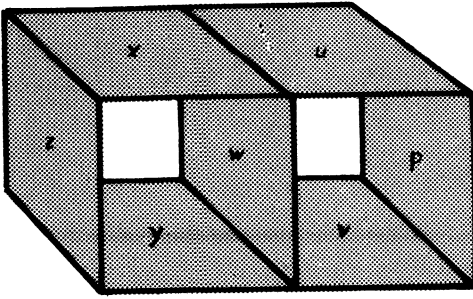

(i)

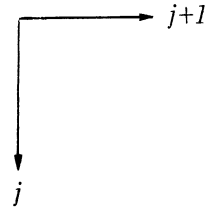
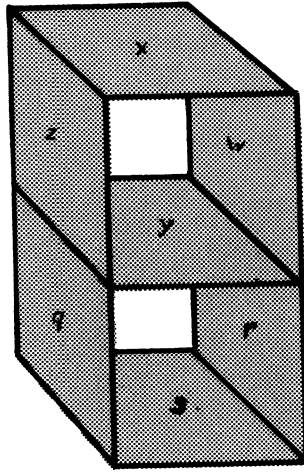

(ii)

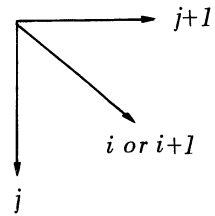
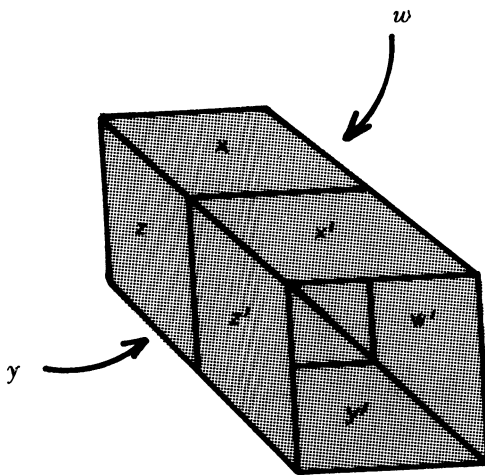

(iii)

initial, final and identity maps respectively.

(ii) The interchange law holds, that is, if $i \neq j$, then

$$(x \underset{i}{+} y) \underset{j}{+} (z \underset{i}{+} w) = (x \underset{j}{+} z) \underset{i}{+} (y \underset{j}{+} w)$$

whenever both sides are defined.

PROOF. (i) There is a graph structure on (K_n, K_{n-1}) with $\partial_j^0, \partial_j^1$ as initial and final maps, and the composition $x \underset{j}{+} y$ is defined if and only if $\partial_j^1 x = \partial_j^0 y$. To prove the associative law suppose also that $\partial_j^1 y = \partial_j^0 z$ and write

$$u = y \underset{j}{+} z, \quad v = x \underset{j}{+} u, \quad e = \epsilon_j \partial_j^1 z.$$

Then by Proposition 10 (i) there is a plug $t_j(x \underset{j}{+} y, e \underset{j}{+} e; v, z)$.

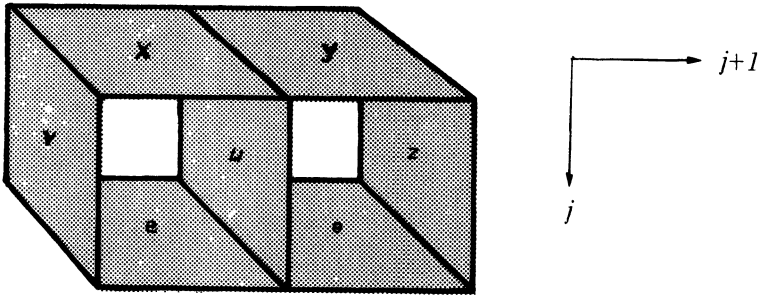

Since $e \underset{j}{+} e = e$ (by Proposition 9), this implies that

$$(x \underset{j}{+} y) \underset{j}{+} z = v = x \underset{j}{+} (y \underset{j}{+} z).$$

We now have associativity, left and right cancellation (Proposition 5) and existence of left identities (Proposition 9). It follows easily that $\underset{j}{+}$ is a groupoid structure and that ϵ_j is its identity map.

(ii) In proving the interchange law we may suppose that $i < j$. Let $x, y, z, w \in K_n$ satisfy

$$\partial_i^1 x = \partial_i^0 y, \quad \partial_i^1 z = \partial_i^0 w, \quad \partial_j^1 x = \partial_j^0 z, \quad \partial_j^1 y = \partial_j^0 w.$$

Write

$$a = (x \underset{j}{+} z), \quad b = (y \underset{j}{+} w), \quad e = \epsilon_j \partial_j^1 z \quad \text{and} \quad f = \epsilon_j \partial_j^1 w.$$

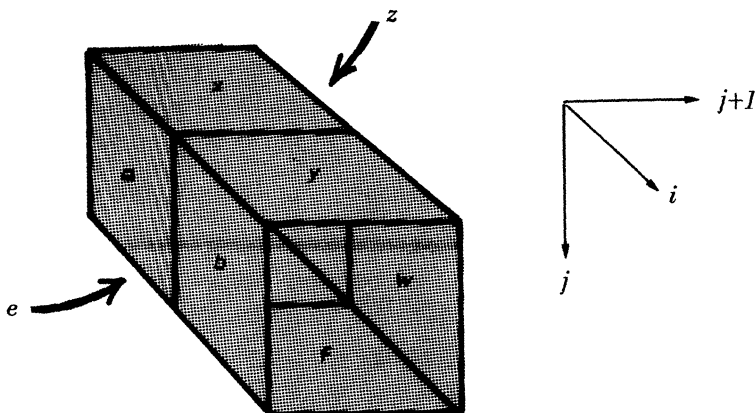

Proposition 11 gives us a plug

$$t_j(x \underset{i}{+} y, e \underset{i}{+} f; a \underset{i}{+} b, z \underset{i}{+} w).$$

But $e \underset{i}{+} f = \epsilon_j \partial_j^0(z \underset{i}{+} w)$ by Proposition 8. So

$$a \underset{i}{+} b = (x \underset{i}{+} y) \underset{j}{+} (z \underset{i}{+} w),$$

as required. \square

REMARK. It is easy to see that an arbitrary socket $s = s_j(x, y; z, w)$ has a plug if and only if $x \underset{j}{+} w = z \underset{j}{+} y$.

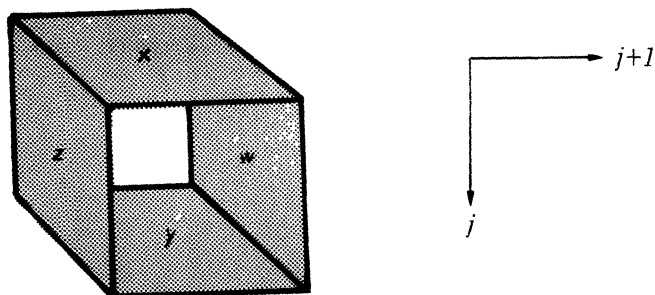

4. ω -GROUPOIDS.

We recall from [4] that an ω -groupoid K is a cubical set with the following extra algebraic structure. Firstly, for each $n \geq 1$, the pair (K_n, K_{n-1}) has n groupoid structures each with objects K_{n-1} and arrows

K_n . For $j = 1, 2, \dots, n$ the groupoid «in the j -th direction» has operations written $\underset{j}{+}$, $\underset{j}{-}$; it has initial and final maps $\partial_j^0, \partial_j^1$ and its identity elements are the degenerate cubes $\epsilon_j \gamma$ ($\gamma \in K_{n-1}$). Here $\underset{j}{-}$ is the inverse operation for $\underset{j}{+}$. The laws satisfied by these operations are the ones which have already been established for the operations $\underset{j}{+}$ of a T -complex in the previous section.

Secondly, an ω -groupoid has *connections*

$$\Gamma_j: K_n \rightarrow K_{n+1} \quad (j = 1, 2, \dots, n)$$

such that $\Gamma_j x$ has the following faces:

- (4) (i) $\partial_j^0 \Gamma_j x = \partial_{j+1}^0 \Gamma_j x = x$,
- (ii) $\partial_j^1 \Gamma_j x = \partial_{j+1}^1 \Gamma_j x = \epsilon_j \partial_j^1 x$,
- (iii) $\partial_i^a \Gamma_j x = \begin{cases} \Gamma_{j-1} \partial_i^a x & \text{if } i < j \\ \Gamma_j \partial_{i-1}^a x & \text{if } i > j+1, \end{cases}$

and the following rules hold:

$$(5) \quad \Gamma_i \Gamma_j = \begin{cases} \Gamma_{j+1} \Gamma_i & \text{if } i \leq j \\ \Gamma_j \Gamma_{i-1} & \text{if } i > j, \end{cases}$$

(6) each of the connections satisfies the transport laws, namely, if $x, y \in K_n$ and $\partial_j^1 x = \partial_j^0 y$, then (see illustrations on the next page)

- (i) $\Gamma_j (x \underset{j}{+} y) = (\Gamma_j x \underset{j+1}{+} \epsilon_j y) \underset{j}{+} \Gamma_j y = (\Gamma_j x \underset{j}{+} \epsilon_{j+1} y) \underset{j+1}{+} \Gamma_j y$,
- (ii) $\Gamma_i (x \underset{j}{+} y) = \begin{cases} \Gamma_i x \underset{j+1}{+} \Gamma_i y & \text{if } i < j \\ \Gamma_i x \underset{j}{+} \Gamma_i y & \text{if } i > j. \end{cases}$

(It is curious that the ∂_j^0, Γ_j together satisfy the rules for the face and degeneracy operators of a simplicial set; this was pointed out by R. Fritsch.)

Suppose now that K is a T -complex. For any

$$x \in K_n \quad \text{and} \quad j = 1, 2, \dots, n,$$

we have a relation

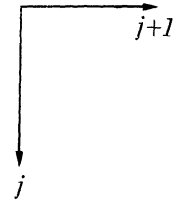
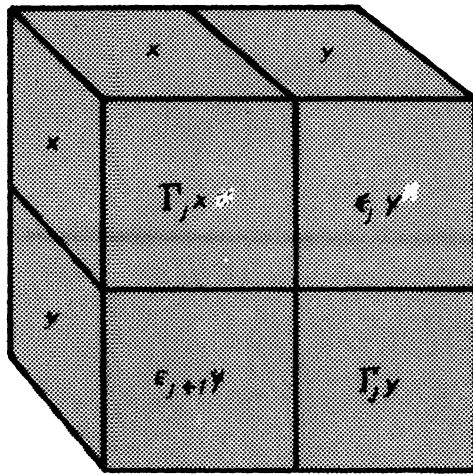

(6) (i)

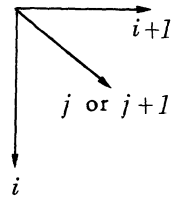
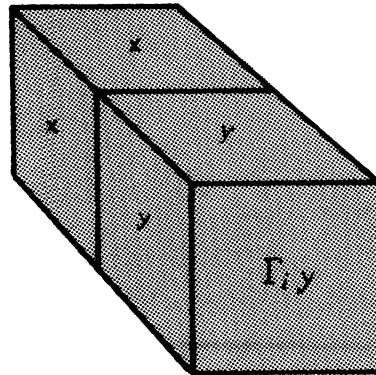

(6) (ii)

$$x \dagger e = e, \text{ where } e = \epsilon_j \partial_j x.$$

So we have a plug $t_j(x, e; x, e)$. We write $\Gamma_j x = t_j(x, e; x, e)$ and call $\Gamma_j: K_n \rightarrow K_{n+1}$ the j -th connection in dimension $n+1$.

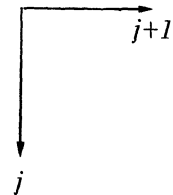
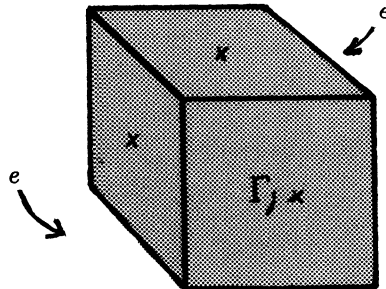

THEOREM A. *With the definitions of \dagger_j, Γ_j given above, the T -complex K is an ω -groupoid.*

PROOF. We have already verified the laws for \dagger_j alone, and we have to prove (4), (5) and (6).

Now (4) (i) and (ii) follow from the definitions, while (4)(iii) follows from Proposition 6.

To prove (6) (i), suppose that $x \dagger_j y$ is defined. We have

$$\begin{aligned} \Gamma_j x &= t_j(x, e; x, e), \quad \text{where } e = \epsilon_j \partial_j^1 x = \epsilon_j \partial_j^0 y; \\ \Gamma_j y &= t_j(y, f; y, f), \quad \text{where } f = \epsilon_j \partial_j^1 y; \end{aligned}$$

and $\epsilon_{j+1} y = t_j(e, f; y, y)$ by Proposition 9. Application of Proposition 11, parts (i) and (ii) gives immediately

$$(\Gamma_j x \dagger_j \epsilon_{j+1} y) \dagger_{j+1} \Gamma_j y = t_j(x \dagger_j y, f \dagger_j f; x \dagger_j y, f \dagger_j f) = \Gamma_j (x \dagger_j y).$$

The other equality in (6) (i) follows by applying the interchange law (Proposition 12 (ii)) to

$$(\Gamma_j x \dagger_j \epsilon_{j+1} y) \dagger_{j+1} (\epsilon_j y \dagger_j \Gamma_j y),$$

using the fact that $\epsilon_j y$ is an identity for the operation \dagger_j . Similarly, (6) (ii) is obtained by a single application of Proposition 11 (ii).

To prove (5) we need the following

LEMMA.

$$\Gamma_p \epsilon_q \partial_q^1 = \begin{cases} \epsilon_{q+1} \partial_{q+1}^1 \Gamma_p & \text{if } p \leq q, \\ \epsilon_q \partial_q^1 \Gamma_p & \text{if } p \geq q. \end{cases}$$

PROOF. If $p < q$, then Proposition 7 (with $i = q+1, j = p$) gives: $\Gamma_p \epsilon_q = \epsilon_{q+1} \Gamma_p$, and the result follows from equations (4) (iii). The case $p > q$ is similar. If $p = q$ we let $x \in K_n$ and write $e = \epsilon_p \partial_p^1 x$. Then we have $\epsilon_p \partial_p^1 e = e$, so

$$\Gamma_p \epsilon_p \partial_p^1 x = t_p(e, e; e, e) = \epsilon_{p+1} e$$

by Proposition 9. However, $\epsilon_{p+1} e = \epsilon_p e$ and also, by (4) (ii),

$$e = \epsilon_p \partial_p^1 x = \partial_p^1 \Gamma_p x = \partial_{p+1}^1 \Gamma_p x.$$

The result is therefore true when $p = q$. \square

Now, consider the rule (5). It is enough to prove that

$$\Gamma_i \Gamma_j x = \Gamma_{j+1} \Gamma_i x \text{ when } x \in K_n \text{ and } 1 \leq i \leq j \leq n.$$

Write $u = \Gamma_i \Gamma_j x$. To show that $u = \Gamma_{j+1} \Gamma_i x$ is by definition to show that

$$u = t_{j+1}(\Gamma_i x, f; \Gamma_i x, f), \text{ where } f = \epsilon_{j+1} \partial_{j+1}^1 \Gamma_i x.$$

So we must prove:

(a) $\partial_{j+1}^0 u = \partial_{j+2}^0 u = \Gamma_i x$;

(b) $\partial_{j+1}^1 u = \partial_{j+2}^1 u = f$;

and (c) the faces of u in all dimensions are thin, except possibly those which are faces of some $\partial_{j+1}^\alpha u$ or $\partial_{j+2}^\alpha u$.

The equations (a) follow directly from (4) (i) and (4) (iii). Also by (4) (ii) and (4) (iii),

$$\partial_{j+2}^1 u = \Gamma_i \partial_{j+1}^1 \Gamma_j x = \Gamma_i \epsilon_j \partial_j^1 x,$$

and this is equal to f by the lemma. When $i < j$, the same argument gives $\partial_{j+1}^1 u = f$, while for $i = j$ we have

$$\partial_{j+1}^1 u = \partial_{j+1}^1 \Gamma_j \Gamma_j x = \epsilon_j \partial_j^1 \Gamma_j x = \epsilon_j^2 \partial_j^1 x$$

and

$$f = \epsilon_{j+1} \partial_{j+1}^1 \Gamma_j x = \epsilon_{j+1} \epsilon_j \partial_j^1 x = \epsilon_j^2 \partial_j^1 x.$$

This proves (b).

Finally, to prove (c), we observe that since

$$u = t_i(\Gamma_j x, e; \Gamma_j x, e), \text{ where } e = \epsilon_i \partial_i^1 \Gamma_j x,$$

all faces of u are thin except possibly those which are faces of some $\partial_i^\alpha u$ or $\partial_{i+1}^\alpha u$. Each of these faces is either $\Gamma_j x$ or e and is therefore of the form $t_j(, ,)$. (Note that $e = \epsilon_i \partial_i^1 \Gamma_j x$ is of the form $\Gamma_j \epsilon_k \partial_k^1 x$ by the Lemma.) It follows that any face of u which is not thin is a face of one of the special faces

$$\partial_p^\alpha \partial_q^\beta u \text{ (} \alpha = 0, 1; \beta = 0, 1; p = j, j+1; q = i, i+1 \text{)}.$$

However, it is easy to verify that each of these special faces is a face of

$\partial_{j+1}^0 u, \partial_{j+1}^1 u, \partial_{j+2}^0 u$ or $\partial_{j+2}^1 u$. This proves (c) and completes the proof of Theorem A. \square

5. THE ISOMORPHISM OF CATEGORIES.

If (K, T) is any T -complex (K being the underlying cubical set and T the collection of thin elements), the construction described above gives an ω -groupoid $\sigma(K, T) = (K, \underset{j}{+}, \Gamma_j)$. Conversely, given an ω -groupoid $(K, \underset{j}{+}, \Gamma_j)$, it was proved in Section 7 of [4] that K carries a T -complex structure in which the thin elements are all composites under the operations $\underset{j}{+}$ of elements of the form

$$\epsilon_i \gamma \text{ or } \underset{i}{-} \dots \underset{l}{-} \Gamma_m \gamma.$$

We abbreviate this last element to $(\pm) \Gamma_m \gamma$, and we denote the resulting T -complex by $\tau(K, \underset{j}{+}, \Gamma_j)$. Both constructions σ and τ are clearly functorial.

THEOREM B. *Let \mathcal{T} denote the category of T -complexes and \mathcal{G} the category of ω -groupoids. Then the functors $\sigma: \mathcal{T} \rightarrow \mathcal{G}$ and $\tau: \mathcal{G} \rightarrow \mathcal{T}$ are inverse isomorphisms.*

PROOF. Let (K, T) be a T -complex and let $\sigma(K, T) = (K, \underset{j}{+}, \Gamma_j)$. Then $\tau \sigma(K, T) = (K, T')$ where T' consists of all composites of elements $\epsilon_i \gamma$ and $(\pm) \Gamma_m \gamma$. By definition of T -complex, $\epsilon_i \gamma \in T$. By definition of Γ_m in a T -complex, $\Gamma_m \gamma \in T$. Also, if $t \in T_n$, we have

$$t \underset{j}{+} (\underset{j}{-} t) = e = \epsilon_j \partial_j^0 t$$

(since $\underset{j}{+}$ gives a groupoid structure on K_n) and so the socket $s_j(t, e; e, \underset{j}{-} t)$ has a plug. Since this plug and all its n -faces other than $\underset{j}{-} t$ are in T_n it follows that $\underset{j}{-} t \in T_n$, by axiom (T3). Hence $(\pm) \Gamma_m \gamma \in T$ and Proposition 10 implies that $T' \subset T$. But this implies that $T' = T$; for if $t \in T_{n+1}$ and b is any box consisting of all n -faces of t except one, then b has a unique filler in T' (see [4], Proposition 7.2), whence $t \in T'_{n+1}$. This proves that $\tau \sigma$ is the identity functor on \mathcal{T} .

Now let (K, \dagger, Γ_j) be any given ω -groupoid and let

$$(K, T') = \tau(K, \dagger, \Gamma_j),$$

where T' is defined as above. To show that $\sigma(K, T') = (K, \dagger, \Gamma_j)$ we must show that, for $x, y \in K_n$,

(i) $\Gamma_j x$ is a plug in (K, T') for the socket $s_j(x, e; x, e)$ where $e = \epsilon_j^1 \partial_j^1 x$,

and (ii) if $\partial_j^1 x = \partial_j^0 y$ then the socket $s_j(x, f; x \dagger y, y)$ where $f = \epsilon_j \partial_j^1 y$, has a plug in (K, T') .

Now $\Gamma_j x$ certainly spans $s_j(x, e; x, e)$. Also, for any cubical operator Δ of $I^{n+1} \setminus S_j^n$, the laws of ω -groupoids imply that $\Delta \Gamma_j x = \Gamma_k \Delta' x$ for suitable k, Δ' , and hence $\Delta \Gamma_j x \in T'$. This proves (i). Similarly, if $\partial_j^1 x = \partial_j^0 y$, the element $t = \Gamma_j x \dagger \epsilon_{j+1} y$ spans $s_j(x, f; x \dagger y, y)$, and $\Delta t \in T'$ since it is of the form $\Gamma_k \Delta' x \dagger \epsilon_{k+1} \Delta' y$. This proves (ii) and completes the proof of Theorem B. \square

REFERENCES.

1. N. ASHLEY, *T-complexes and crossed complexes*, Ph. D. Thesis, University of Wales, 1978.
2. A.L. BLAKERS, Some relations between homology and homotopy groups, *Ann. of Math.* 49 (1948), 428-461.
3. R. BROWN, Higher dimensional group theory, in *Low dimensional topology*, ed. Brown & Thickstun, London Math. Soc. Lecture Notes 48, Cambridge, 1982.
4. R. BROWN & P. J. HIGGINS, On the algebra of cubes, *J. Pure Appl. Algebra*, 21 (1981), 233-260.
5. R. BROWN & P. J. HIGGINS, Colimit theorems for relative homotopy groups, *J. Pure Appl. Algebra*, 22 (1981), 11-41.
6. R. BROWN & P. J. HIGGINS, The equivalence of ∞ -groupoids and crossed complexes, This same issue.
7. M.K. DAKIN, *Kan complexes and multiple groupoid structures*, Ph. D. Thesis, University of Wales, 1977.
8. A. DOLD, Homology of symmetric products and other functors of complexes, *Ann. of Math.* 68 (1958), 54-80.
9. J. HOWE, Pullback functors and crossed complexes, *Cahiers Topo. et Géom. Diff.* XX-3 (1979), 281-296.
10. D.M. KAN, Abstract homotopy theory I, *Proc. Nat. Acad. Sci. U. S. A.* 41 (1955), 1092-1096.
11. D.M. KAN, Functors involving c. s. s. complexes, *Trans. A.M.S.* 87 (1958), 330-346.
12. J.H.C. WHITEHEAD, Combinatorial homotopy II, *Bull. A.M.S.* 55 (1949), 453-496.

R. BROWN: School of Mathematics
and computer Science
University College of North Wales
BANGOR LL57 2UW, Gwynedd, U.K.

P. J. HIGGINS: Department of Mathematics
University of Durham
Science Laboratories
South Road
DURHAM DH1 3LE, U.K.