

# *Astérisque*

T. JÓZEFIAK

P. PRAGACZ

J. WEYMAN

**Resolutions of determinantal varieties and tensor complexes associated with symmetric and antisymmetric matrices**

*Astérisque*, tome 87-88 (1981), p. 109-189

[http://www.numdam.org/item?id=AST\\_1981\\_\\_87-88\\_\\_109\\_0](http://www.numdam.org/item?id=AST_1981__87-88__109_0)

© Société mathématique de France, 1981, tous droits réservés.

L'accès aux archives de la collection « Astérisque » (<http://smf4.emath.fr/Publications/Asterisque/>) implique l'accord avec les conditions générales d'utilisation (<http://www.numdam.org/conditions>). Toute utilisation commerciale ou impression systématique est constitutive d'une infraction pénale. Toute copie ou impression de ce fichier doit contenir la présente mention de copyright.

NUMDAM

Article numérisé dans le cadre du programme  
Numérisation de documents anciens mathématiques

<http://www.numdam.org/>

RESOLUTIONS OF DETERMINANTAL VARIETIES AND TENSOR COMPLEXES  
ASSOCIATED WITH SYMMETRIC AND ANTISYMMETRIC MATRICES

T. Józefiak, P. Pragacz, J. Weyman

Contents

1. Introduction
2. Preliminaries
3. Components of minimal free resolutions
  - A. Antisymmetric matrices
  - B. Symmetric matrices
4. Symplectic and orthogonal Schur complexes
5. Explicit description of minimal free resolutions  
in low codimension

1. INTRODUCTION

Let  $K$  be a commutative ring and fix an integer  $n \geq 1$ . The polynomial ring  $K[\{T_{ij}\}]$ ,  $1 \leq i \leq j \leq n$ , in  $n(n+1)/2$  variables  $T_{ij}$  can be treated as a coordinate ring  $\mathcal{O}_X$  of the affine space  $X = \text{Sym}_n(K)$  of all  $n$  by  $n$  symmetric matrices. For a given  $r < n$  let  $Y_r$  be the subvariety of  $X$  of all matrices of rank at most  $r$ . The determinantal varieties  $Y_r$  have been the classical object of intensive study. Let us recall here their relationship with classical invariant theory in case  $K$  is a field of characteristic 0.

Let  $Z = (Z_{ij})$  be an  $r \times n$  matrix of indeterminates. The orthogonal group  $O(r)$  acts on the polynomial ring  $S = K[\{Z_{ij}\}]$  by the formula

$$Z_{ij} \mapsto (BZ)_{ij} \quad , \quad B \in O(r) \quad ,$$

and the ring of invariants  $S^{O(r)}$  of this action is equal to  $K[\{({}^tZZ)_{ij}\}]$ . Consider a map  $K[\{T_{ij}\}] \rightarrow S^{O(r)}$  sending  $T_{ij}$  into  $({}^tZZ)_{ij}$ . The second fundamental theorem of invariant theory, [Weyl], tells us that the kernel of this map is equal to the ideal  $I_{r+1}(T)$  generated by all the  $(r+1)$ -order minors of  $T = (T_{ij})$ , where  $T_{ij} = T_{ji}$  for  $i > j$ . Therefore  $S^{O(r)}$  can be identified with the coordinate ring of  $Y_r$ .

This paper can be considered as a continuation of those classical results because it is devoted to explicit descriptions of a minimal free resolution (i.e. all the higher syzygies) of  $S^{O(r)} = \mathcal{O}_{Y_r} = \mathcal{O}_X/I_{r+1}(T)$  over  $\mathcal{O}_X$  when  $\mathcal{O}_X$  contains the field of rational integers.

*RESOLUTIONS OF DETERMINANTAL VARIETIES*

Simultaneously we treat the corresponding problem for antisymmetric (= alternating) matrices. To be precise, let  $K[\{T_{ij}\}]$ ,  $1 \leq i < j \leq n$ , be the polynomial ring in  $(n-1)n/2$  variables  $T_{ij}$ . It can be considered as the coordinate ring  $\mathcal{O}_X$  of the affine space  $X = \text{Alt}_n(K)$  of all  $n$  by  $n$  antisymmetric matrices. If  $Y_{2p}$  is the subvariety of  $X$  of all matrices of rank at most  $2p$ , then the ideal  $\text{Pf}_{2p+2}(T)$  of functions on  $X$  vanishing on  $Y_{2p}$  is generated by all the  $(2p+2)$ -order pfaffians of  $T = (T_{ij})$ , where  $T_{ij} = -T_{ji}$  for  $i > j$ ,  $T_{ii} = 0$  (see [De Concini-Procesi]).

Pfaffians appear also in invariant theory. Let  $Z = (Z_{ij})$  be  $2p \times n$  matrix of indeterminates,  $2p+2 \leq n$ . The symplectic group  $\text{Sp}(2p)$  acts on the polynomial ring  $S = K[\{Z_{ij}\}]$  by the same formula as in the case of the orthogonal group. However in this case the ring of invariants  $S^{\text{Sp}(2p)}$  is equal to  $K[\{({}^tZJZ)_{ij}\}]$  where  $J$  is the standard antisymmetric matrix:  $J = \begin{pmatrix} 0 & I \\ -I & 0 \end{pmatrix}$ ,  $I = \begin{pmatrix} 0 & & 1 \\ & \ddots & \\ 1 & & 0 \end{pmatrix}$ . Mapping  $K[\{T_{ij}\}]$  onto  $S^{\text{Sp}(2p)}$  by sending  $T_{ij}$  to  $({}^tZJZ)_{ij}$  one can identify  $S^{\text{Sp}(2p)}$  with  $K[\{T_{ij}\}]/\text{Pf}_{2p+2}(T)$  [De Concini-Procesi]. This is the second fundamental theorem of invariant theory for the given action of  $\text{Sp}(2p)$ .

We also present in this paper our description of a minimal free resolution of  $S^{\text{Sp}(2p)} = \mathcal{O}_{Y_{2p}} = \mathcal{O}_X/\text{Pf}_{2p+2}(T)$  over  $\mathcal{O}_X$  when  $\mathcal{O}_X$  contains the field of rational integers.

An analogous problem for minors of a general generic matrix is treated in [Lascoux] and [Roberts] (see also [Nielsen]).

We recall that in both the symmetric and antisymmetric cases  $Y_r$  is a Cohen-Macaulay variety; see [Kutz],

[Kleppe-Laksov] and comments in [Laksov]. Therefore the length of a minimal free resolution of  $\mathcal{O}_{Y_r}$  over  $\mathcal{O}_X$  is equal to the depth of the ideal of functions vanishing on  $Y_r$ . This number is  $(n-r)(n-r+1)/2$  in the symmetric case, [Kutz], and  $(n-2p-1)(n-2p)/2$  in the antisymmetric case, [Józefiak-Pragacz],  $r = 2p$ .

To describe our results we need a basis free point of view. Instead of speaking of  $T$  we consider a map (symmetric or antisymmetric)  $\varphi : E^* \rightarrow E$ , where  $E$  is a free  $\mathcal{O}_X$ -module of rank  $n$  and  $T$  is the matrix of  $\varphi$  in a basis of  $E$  and its dual basis of  $E^*$ . We also write  $I_{r+1}(\varphi)$ ,  $\text{Pf}_{2p+2}(\varphi)$  instead of  $I_{r+1}(T)$ ,  $\text{Pf}_{2p+2}(T)$ , respectively.

In section 3 we compute components of minimal free resolutions of  $I_{r+1}(\varphi)$  and  $\text{Pf}_{2p+2}(\varphi)$  in terms of the Schur modules of  $E$ . We apply a method which comes essentially from [Kempf] and was developed and used in [Lascoux] for solving an analogous problem for minors of a general matrix. We will illustrate the method for antisymmetric matrices.

Treating  $E$  as a trivial vector bundle over  $X$ , let us consider a grassmannian  $G = G_{n-p}(E^*)$  parameterizing subbundles of  $E^*$  of rank  $n-p$ . Let  $\pi : G \rightarrow X$  be the canonical projection and  $0 \rightarrow F \xrightarrow{\eta} E^* \rightarrow Q \rightarrow 0$  the tautological exact sequence on  $G$  (where we write  $E^*$  instead of  $\pi^*E^*$  for short). Since the composition

$$\tilde{\varphi} : F \xrightarrow{\eta} E^* \xrightarrow{\varphi} E \xrightarrow{\eta^*} F^*$$

is again antisymmetric it induces a cosection  $\Lambda^2 F \rightarrow \mathcal{O}_G$  and we define a subvariety  $W \subset G$  by putting  $\mathcal{O}_W = \text{Coker}(\Lambda^2 F \rightarrow \mathcal{O}_G)$ .

We have  $\pi(W) \subset Y_{2p}$  (Lemma 3.1) and hence a commutative diagram

$$\begin{array}{ccc} W & \hookrightarrow & G \\ \downarrow & & \downarrow \pi \\ Y_{2p} & \hookrightarrow & X \end{array}$$

We study syzygies of  $\mathcal{O}_{Y_{2p}}$  over  $\mathcal{O}_X$  by analyzing a spectral sequence of hypercohomology associated with  $\pi$  and the Koszul complex of  $\mathcal{O}_W$  over  $\mathcal{O}_G$ ,  $W$  being locally a complete intersection in  $G$ .

Although  $\pi$  does not induce a birational isomorphism of  $W$  and  $Y$  (as in [Kempf] and [Lascoux]) we obtain complete knowledge of the higher syzygies in the antisymmetric case (Theorem 3.14) by using an explicit  $\pi_*$ -acyclic resolution of the Koszul complex of  $\mathcal{O}_W$  over  $\mathcal{O}_G$ .

In the symmetric case we also apply variant of this method to get the final result (Theorem 3.19).

The main results of section 3 were announced without proofs in [Lascoux] and [Józefiak-Pragacz].

It seems to be rather difficult to define differentials explicitly and to prove the exactness of the complex with the above mentioned description in terms of the Schur modules. However some examples of another approach are already known for determinantal varieties of low codimension (see [Józefiak], [Józefiak-Pragacz]). One uses both  $E$  and  $E^*$  to describe components and this makes it easier to define differentials by means of  $\varphi$ .

These examples lead to a discovery of a very fruitful characterization of symmetric and antisymmetric maps which we exploit in the remaining sections of the paper.

With an arbitrary map  $\varphi : E^* \rightarrow E$  treated as a complex and given a partition  $I$ , one can associate a complex  $S_I\varphi$  (the so-called Schur complex of  $\varphi$ ) in a similar manner as for modules (see [Nielsen], [Akin-Buchsbaum-Weyman]). In particular  $S_{(1,1)}\varphi = \Lambda^2\varphi$  is a complex  $S_2E^* \rightarrow E^* \otimes E \rightarrow \Lambda^2E$  and  $S_2\varphi$  is a complex  $\Lambda^2E^* \rightarrow E^* \otimes E \rightarrow S_2E$ , where morphisms are induced by  $\varphi$ . A map  $\varphi : E^* \rightarrow E$  is antisymmetric if and only if the map

$$\begin{array}{ccc} \Lambda^2E & \rightarrow & 0 \\ \uparrow & & \uparrow \\ E^* \otimes E & \rightarrow & \mathcal{O}_X \\ \uparrow & & \uparrow \\ S_2E^* & \rightarrow & 0 \end{array}$$

is a map of complexes where the only non-zero horizontal map is the evaluation map. Therefore an antisymmetric  $\varphi$  (i.e. a map  $\Lambda^2E^* \rightarrow \mathcal{O}_X$ ) induces a map of complexes  $\Lambda^2\varphi \rightarrow \mathcal{O}_X$  [1]. Taking this as a starting point, in section 4 we study an analogue of the Brauer-Weyl algebra of the symplectic group for complexes, and those complexes which correspond to the irreducible representations of the symplectic group.

Similar results also hold for a symmetric map  $\varphi$  (which induces a map of complexes  $S_2\varphi \rightarrow \mathcal{O}_X$  [1]); these find their source in the analogy with the orthogonal group.

In section 5 we use ideas and results from section 4 to construct explicit minimal free resolutions of  $\mathcal{O}_{Y_r}$  over  $\mathcal{O}_X$  (including differentials) for  $r+1 = n-1, n-2$  in the symmetric case and for  $r+2 = n-1, n-2, n-3$  in the antisymmetric case.

Some of the above results are contained in the doctoral

dissertation, [Pragacz], of the second named author.

We would like to thank A. Lascoux and M. Miller for a very careful reading of the manuscript and for their valuable comments. Thanks are also due to J.-E. Roos for arranging for the typing of this manuscript.

2. PRELIMINARIES

Partitions

By a partition  $I$  we mean a weakly decreasing sequence of non-negative integers  $(i_1, i_2, \dots, i_m)$ . The non-zero numbers  $i_k$  are called the parts of  $I$ . We think of  $I$  as a sequence of squares of lengths  $i_1, i_2, \dots$  and express it pictorially in the plane by its diagram. For example,



is the diagram of the partition  $(4, 3, 1)$ .

If  $i_m \neq 0$  then  $m$  is called the length of  $I$ ,  $m = \lg I$ , and  $|I| = \sum_{k=1}^m i_k$  its weight. The length of the diagonal of  $I$  is called the rank of  $I$ . For example, the diagonal of the partition  $(4, 3, 1)$  is shaded in (2.1) and is of length 2.

Sometimes we use a notation for  $I$  which indicates the number of times each integer occurs as a part:

$$I = (1^{n_1}, 2^{n_2}, \dots, k^{n_k}, \dots)$$

means that exactly  $n_k$  of the parts of  $I$  are equal to  $k$ .

To each square of a partition one can associate its



arm which is a set of all squares in the same row lying to the right of the given square, and its neck which is formed by all squares lying in the same column above the given square.

Still another notation for a partition  $I$  is occasionally useful. If  $a_k$  is the length of the arm of the  $k$ -th diagonal square of  $I$  and  $b_k$  is the length of its neck then we write (after Frobenius)  $I = (a_1, \dots, a_r | b_1, \dots, b_r)$  where  $r = \text{rank } I$ . For example,  $(4, 3, 1) = (3, 1 | 2, 0)$ .

For two partitions  $I, J$  we write  $I \supset J$  if  $i_k \geq j_k$  for all  $k$ . If the columns of the diagram of  $I$  are of lengths  $j_1, \dots, j_q$  (in a weakly decreasing order) then the partition  $J$  is called the conjugate of  $I$  and denoted by  $I^\sim$ .

For two partitions  $I, J$  such that  $I \supset J$  we write  $I/J$  for a corresponding skew partition. Its diagram is obtained as a set-theoretic difference of the diagrams of  $I$  and  $J$ . For example

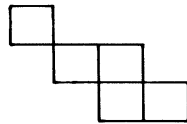

is the diagram of the skew partition  $(4, 3, 1)/(2, 1)$ . The diagram of  $I/J$  has rows of lengths  $i_1 - j_1, i_2 - j_2, \dots$ . The weight  $|I/J|$  of  $I/J$  is defined as the difference  $|I| - |J|$ . We denote  $(I/J)^\sim = I^\sim/J^\sim$  and call it the conjugate of  $I/J$ .

We identify a partition  $I$  with a skew partition  $I/(0, 0, \dots)$ .

Schur modules

Let  $R$  be a commutative  $\mathbb{Q}$ -algebra,  $E$  an  $R$ -module and  $I/J$  a skew partition.

We write  $S_{I/J}E$  for the Schur module of  $E$  associated with  $I/J$  (see [Lascoux], [Nielsen], [Towber]). We also use the notation  $\Lambda_{I/J}E = S_{(I/J)}\sim E$ . The module  $S_{I/J}E$  depends functorially on  $E$  and the corresponding covariant functor is denoted by  $S_{I/J}$ .

We will need the following formulas involving Schur modules in the sequel. Let  $E, F$  denote free  $R$ -modules of finite rank.

The linearity formula

$$(2.2) \quad S_I(E \oplus F) = \bigoplus_J S_{I/J}E \oplus S_JF$$

where the sum ranges over all partitions  $J$  contained in  $I$ .

Plethysm formulas

$$(2.3) \quad S_m(S_2E) = \bigoplus S_I E$$

summed over all partitions  $I$  of weight  $2m$  with even parts and  $\lg I \leq \text{rank } E$ ;

$$(2.4) \quad S_m(\Lambda^2 E) = \bigoplus \Lambda_I E$$

summed over the same set of partitions as in (2.3);

$$(2.5) \quad \Lambda^m(\Lambda^2 E) = \bigoplus S_I E$$

summed over all partitions  $I$  of weight  $2m$  of the form  $(a_1, \dots, a_r \mid a_1+1, \dots, a_r+1)$  and  $\lg I \leq \text{rank } E$ ;

$$(2.6) \quad \Lambda^m(S_2 E) = \oplus \Lambda_I E$$

summed over the same set of partitions as in (2.5).

The Cauchy formula

$$(2.7) \quad S_m(E \otimes F) = \oplus S_I E \otimes S_I F$$

summed over all partitions I of m.

The Littlewood - Richardson rule

$$(2.8) \quad S_I E \otimes S_J E = \oplus (I, J; L) S_L E$$

where the multiplicities  $(I, J; L)$  have a combinatorial interpretation in terms of lattice permutations, e.g.

$(I, J; L) = 0$  if  $I \not\subset L$  or  $J \not\subset L$  and if  $|I| + |J| \neq |L|$ .

A special case of (2.8) is known as the Pieri formula

$$(2.9) \quad S_r E \otimes S_J E = \oplus S_L E$$

summed over all partitions L containing J such that  $|L| = |J| + r$  and  $L/J$  has at most one square in each column.

$$(2.10) \quad S_{I/r} E = \oplus S_J E$$

summed over all partitions J contained in I such that  $|I| = |J| + r$  and  $I/J$  has at most one square in each column.

$$(2.11) \quad S_{I/(1^r)} E = \oplus S_J E$$

summed over all partitions J contained in I such that  $|I| = |J| + r$  and  $I/J$  has at most one square in each row.

We refer to [Macdonald] for all these formulas in terms of Schur functions. Moreover the Littlewood - Richardson rule

is treated in detail in [Schützenberger] and [Thomas], and a more general approach in terms of shuffles of words can be found in [Lascoux - Schützenberger]

(2.12) If  $E$  is a free  $R$ -module of finite rank then  $S_I E$  is again free and its rank is equal to the number of standard Young tableaux of shape  $I$  filled out by elements of a fixed basis of  $E$  (see [Towber]).

Schur complexes

If  $C = \{C^k\}$  is a module graded by the ring of integers, then we adopt standard convention and write  $C[n]$  for the module  $C$  shifted by  $n$ , i.e.  $C[n]^k = C^{n+k}$ . In particular this applies to complexes. We often write  $C_{-k}$  instead of  $C^k$  if  $k \leq 0$ . For a complex  $C^\bullet$  let  $C^{\bullet \otimes m}$  be its  $m$ -th tensor product. The symmetric group  $\Sigma_m$  acts on  $C^{\bullet \otimes m}$  by permuting factors (up to a sign). For a partition  $I$  of  $m$  let  $e(I)$  be a primitive idempotent in the group algebra of  $\Sigma_m$  corresponding to  $I$ . We define  $S_I C^\bullet$  to be  $e(I)C^{\bullet \otimes m}$  and call it the Schur complex of  $C^\bullet$  associated with  $I$ . For other definitions of Schur complexes, see [Nielsen] and [Akin-Buchsbaum-Weyman]. As for modules we also write  $\Lambda_I C^\bullet$  instead of  $S_I \sim C^\bullet$ . If  $C^\bullet: \dots \rightarrow 0 \rightarrow C^0 \rightarrow C^1 \rightarrow 0 \rightarrow \dots$ , then the components of  $S_I C^\bullet$  can be described in terms of the Schur modules of  $C^0$  and  $C^1$  in the following way, [Nielsen].

$$(2.13) \quad \Lambda_I C^0 \rightarrow \bigoplus_{|J|=1} \Lambda_{I/J} C^0 \otimes C^1 \rightarrow \dots \rightarrow \bigoplus_{|J|=k} \Lambda_{I/J} C^0 \otimes S_J C^1 \\ \rightarrow \dots \rightarrow S_I C^1$$

In particular

$$(2.14) \quad \Lambda^m C^* : S_m C^0 \rightarrow \dots \rightarrow S_i C^0 \otimes \Lambda^{m-i} C^1 \rightarrow \dots$$

$$\rightarrow C^0 \otimes \Lambda^{m-1} C^1 \rightarrow \Lambda^m C^1$$

$$(2.15) \quad S_m C^* : \Lambda^m C^0 \rightarrow \dots \rightarrow \Lambda^i C^0 \otimes S_{m-i} C^1 \rightarrow \dots$$

$$\rightarrow C^0 \otimes S_{m-1} C^1 \rightarrow S_m C^1$$

Moreover, it follows from [Nielsen] that

$$(2.16) \quad \Lambda^m(C^0 \rightarrow C^1 \rightarrow C^2)^t = \oplus \Lambda^a(C^0) \otimes S_b(C^1) \otimes \Lambda^c(C^2)$$

and the sum ranges over all triples of integers  $a, b, c$  such that  $a+b+c = m$ ,  $b+2c = t$ .

In section 3 we will need the following

Lemma (2.17) If  $C^* : 0 \rightarrow C^0 \rightarrow C^1 \rightarrow \dots \rightarrow C^n \rightarrow 0$  is an exact sequence of vector spaces, then the complex

$$0 \rightarrow \Lambda^m C^0 \rightarrow \Lambda^m(C^1 \rightarrow \dots \rightarrow C^n) \rightarrow 0$$

is exact.

Proof Using the formula  $\Lambda^m(C^* \oplus D^*) \simeq \bigoplus_{i=0}^m \Lambda^{m-i} C^* \otimes \Lambda^i D^*$  (see. [Nielsen]) one easily checks that any complex of the type  $\Lambda^m(\dots \rightarrow 0 \rightarrow M \xrightarrow{\text{id}} M \rightarrow 0 \rightarrow \dots)$  is exact. Now write  $C^*$  as a direct sum

$$(C^0 \rightarrow \dots \rightarrow C^n) = (C^0 \rightarrow \dots \rightarrow C_1^{n-1} \rightarrow 0) \oplus (0 \rightarrow \dots \rightarrow C_2^{n-1} \xrightarrow{\text{Id}} C^n)$$

Once again applying the above mentioned formula we get our claim by induction on  $n$ .

The Bott theorem

Definition (2.18) We define a map  $P : \mathbb{N}^k \cup \phi \rightarrow \{\text{partitions}\} \cup \phi$  where  $\mathbb{N}$  is the set of natural numbers,  $k \geq 2$ , and  $\phi$  denotes the empty set. We put  $P(\phi) = \phi$  and for  $k = 2$

$$P(a,b) = \begin{cases} (a,b) & \text{if } a \geq b, \\ (b-1, a+1) & \text{if } a < b-1, \\ \phi & \text{if } a = b-1. \end{cases}$$

We call  $P(a,b)$  the elementary rectification of  $(a,b)$ .

Let  $k > 2$  and  $(a_1, \dots, a_k) \in \mathbb{N}^k$ . We define a sequence  $(s_1, \dots, s_k) \in \mathbb{N}^k$  as follows:  $P(a_1, a_2) = (s_1, b_2)$ ,  $P(b_2, a_3) = (s_2, b_3)$ ,  $P(b_3, a_4) = (s_3, b_4)$ ,  $\dots$ ,  $P(b_{k-2}, a_{k-1}) = (s_{k-2}, b_{k-1})$ ,  $P(b_{k-1}, a_k) = (s_{k-1}, s_k)$ . If for some  $i$   $P(b_i, a_{i+1}) = \phi$  (where we put  $b_1 = a_1$ ) we define  $P(a_1, \dots, a_k) = \phi$ . When this is not the case we put

$$P(a_1, \dots, a_k) = \begin{cases} (c_1, \dots, c_{k-1}, s_k) & \text{if } P(s_1, \dots, s_{k-1}) = (c_1, \dots, c_{k-1}) \\ \phi & \text{if } P(s_1, \dots, s_{k-1}) = \phi. \end{cases}$$

It follows from [Lascoux] that  $P(a_1, \dots, a_k)$  (if non-empty) is a partition. We call  $P(a_1, \dots, a_k)$  the rectification of  $(a_1, \dots, a_k)$ .

We write  $m(a_1, \dots, a_k)$  for the minimal number of elementary rectifications needed to pass from  $(a_1, \dots, a_k)$  to  $P(a_1, \dots, a_k)$  and different from the identity. For example,  $P(1, 3, 6) = (4, 3, 3)$ ,  $m(1, 3, 6) = 3$ .

Let  $X$  be a variety defined over a field of characteristic 0. For a vector bundle  $E$  of rank  $n$  over  $X$  and a fixed number  $r < n$  consider a grassmannian  $G_r(E)$  parameterizing subbundles of  $E$  of rank  $r$ . Let  $\pi : G_r(E) \rightarrow X$  be the canonical

projection and  $0 \rightarrow R \rightarrow E \xrightarrow{\rho} Q \rightarrow 0$  the tautological exact sequence on  $G_r(E)$  (we write  $E$  instead of  $\pi^*E$ ) so that  $\text{rank } R = r$ ,  $\text{rank } Q = q$ ,  $r + q = n$ . For a partition  $I$  of length  $\leq r$  we write

$$I' = P(\underbrace{0, \dots, 0}_q, i_1, \dots, i_r), \quad n(I) = m(\underbrace{0, \dots, 0}_q, i_1, \dots, i_r) .$$

Now we are ready to recall the Bott theorem as stated in [Lascoux].

Theorem (2.19) If  $R^i \pi_*$  are higher direct images of  $\pi$ , then

$$\begin{aligned} 1) \quad R^0 \pi_*(S_I Q) &= S_I E \quad \text{for } \text{lg } I \leq q , \\ R^k \pi_*(S_I Q) &= 0 \quad \text{for } k \geq 1 . \end{aligned}$$

Moreover

$$R^0 \pi_*(S_I(\rho)) : S_I E \rightarrow S_I Q = S_I E \xrightarrow{\text{Id}} S_I E$$

if  $\text{lg } I \leq q$ .

$$2) \quad R^k \pi_*(S_I R) = \begin{cases} 0 & \text{if } k \neq n(I) , \\ S_{I, E} & \text{if } k = n(I) , \end{cases}$$

and  $n(I) = q \cdot \text{rank } I$ .

*RESOLUTIONS OF DETERMINANTAL VARIETIES*

3. COMPONENTS OF MINIMAL FREE RESOLUTIONS

A. Antisymmetric matrices

We assume throughout this section that the coefficient field  $K$  has characteristic zero. From the point of view of the final description of minimal free resolutions it is not restrictive to assume also that  $K$  is algebraically closed.

We identify the affine space  $X = \text{Alt}_n(K)$  of all  $n \times n$  antisymmetric matrices over  $K$  with  $\Lambda^2 V$ , where  $V$  is a vector space of dimension  $n$  over  $K$ . For  $U = V^*$  the symmetric algebra  $S_*(\Lambda^2 U)$  can be treated as the coordinate ring  $\mathcal{O}_X$  of  $X$ .

Let  $E$  be a trivial vector bundle over  $X$ . The canonical section of  $\Lambda^2 E$  induces a generic antisymmetric morphism  $\varphi : E^* \rightarrow E$ . If  $\{v_i\}$  is a basis of  $V$ ;  $\{v_i^*\}$  the dual basis of  $U$  and  $T_{ij} = v_i^* \wedge v_j^*$ , then  $T = (T_{ij})$  is the matrix of  $\varphi$  with respect to  $\{v_i^*\}$  and  $\{v_i\}$ . It follows from the plethysm formula for  $S_m(\Lambda^2 U)$  (see (2.4)) that there exists only one (up to a scalar) natural map  $\Lambda^{2m} U \rightarrow S_m(\Lambda^2 U)$ . For instance

$$\alpha : u_1 \wedge \dots \wedge u_{2m} \mapsto \sum_{\sigma \in \Sigma_{2m}} \text{sign } \sigma (u_{\sigma(1)} \wedge u_{\sigma(2)}) \dots (u_{\sigma(2m-1)} \wedge u_{\sigma(2m)})$$

is such a map where the sum ranges over the symmetric group  $\Sigma_{2m}$  on  $2m$  letters. We define

$$\text{Pf} = (2^m m!)^{-1} \alpha$$

and call it the pfaffian map. Explicitly:

$$\text{Pf}(u_1 \wedge \dots \wedge u_{2m}) = \sum_{\sigma \in \Sigma_{2m} / \Gamma_m} \text{sign } \sigma \prod_{k=1}^m (u_{\sigma(2k-1)} \wedge u_{\sigma(2k)}) ,$$

where  $\Gamma_m$  is the subgroup of  $\Sigma_{2m}$  (of order  $2^m m!$ ) consisting of those permutations which leave the set of sets



$\{\{1,2\}, \{3,4\}, \dots, \{2m-1,2m\}\}$  invariant. For example, for  $m = 2$

$$\begin{aligned} & \text{Pf}(u_1 \wedge u_2 \wedge u_3 \wedge u_4) \\ &= (u_1 \wedge u_2)(u_3 \wedge u_4) - (u_1 \wedge u_3)(u_2 \wedge u_4) + (u_1 \wedge u_4)(u_2 \wedge u_3) . \end{aligned}$$

The ideal in  $\mathcal{O}_X$  generated by the image of Pf is called the ideal of  $2m$ -order pfaffians of  $\varphi$  and will be denoted by  $\text{Pf}_{2m}(\varphi)$ . A more familiar description of  $\text{Pf}_{2m}$  is in terms of the matrix  $T$  mentioned above. For a subset  $\{i_1, \dots, i_{2m}\}$  of  $\{1, \dots, n\}$ ,  $\text{Pf}(v_{i_1}^* \wedge \dots \wedge v_{i_{2m}}^*)$  is usually called the  $2m$ -order pfaffian of  $T$  determined by rows and columns  $i_1, \dots, i_{2m}$  of  $T$ . Therefore  $\text{Pf}_{2m}(\varphi)$  is generated by all the  $2m$ -order pfaffians of  $T$ .

We write  $Y_{2m}$  for the subvariety of  $X$  of all matrices of rank at most  $2m$ ; by [De Concini-Procesi]  $\mathcal{O}_{Y_{2m}} = \mathcal{O}_X / \text{Pf}_{2m+2}(\varphi)$ .

Main geometric construction

For a fixed natural number  $p$  such that  $2p+2 \leq n$  let us consider a relative grassmannian  $G = G_{n-p}(E^*)$  which parameterizes subbundles of  $E^*$  of rank  $n-p$  and let  $\pi : G \rightarrow X$  be the canonical projection. There is a tautological exact sequence

$$(1) \quad 0 \rightarrow F \xrightarrow{\eta} E^* \xrightarrow{\rho} Q \rightarrow 0$$

of vector bundles over  $G$ . Consider the following antisymmetric morphism:

$$\tilde{\varphi} : F \xrightarrow{\eta} E^* \xrightarrow{\varphi} E \xrightarrow{\eta^*} F^*$$

We define a subvariety  $W$  of  $G$  as the subvariety of zeros of the associated cosection  $\Lambda^2 F \rightarrow \mathcal{O}_G$ , i.e.  $\mathcal{O}_W = \text{Coker}(\Lambda^2 F \rightarrow \mathcal{O}_G)$ .

**RESOLUTIONS OF DETERMINANTAL VARIETIES**

A point  $g$  of  $G$  is a pair  $(x, F_x)$  where  $x \in X$  and  $F_x$  is a subspace of  $E_x^*$  of dimension  $n-p$ . Observe that  $\varphi$  induces an alternating form on each fibre  $E_x^*$ . Therefore  $g = (x, F_x)$  is in  $W$  iff  $F_x$  is an isotropic subspace of  $E_x^*$  with respect to that form. Basic properties of  $W$  are contained in

Lemma 3.1 (a)  $\pi(W) \subset Y_{2p}$

(b)  $W$  is locally a complete intersection in  $G$  of codimension  $\binom{n-p}{2}$ .

Proof (a) In view of the remark preceding the lemma it is enough to prove that the existence of an isotropic subspace  $F_x$  of  $E_x^*$  of dimension  $n-p$  implies that  $\text{rk } x < 2p+2$ . By assumption a matrix of  $\varphi_x$  has the form

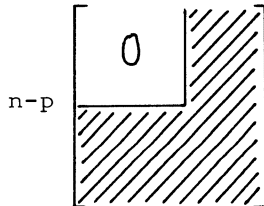

in some basis of  $E_x^*$ . By the Laplace expansion it follows easily that every  $(2p+1)$ -order minor of such a matrix is equal to zero.

(b) We restrict ourselves to a standard affine open subset  $\Gamma$  of  $G$ , say, determined by the sequence  $(1, 2, \dots, n-p)$ . A point  $g = (x, F_x)$  belongs to  $\Gamma$  if  $F_x$  is generated by rows of a matrix of the form

$$n-p \left[ \begin{array}{ccc|c} 1 & & & 0 \\ & \cdot & & \\ & & \cdot & \\ & & & \cdot \\ 0 & & & 1 \end{array} \right] \begin{array}{c} \text{diagonal lines} \\ \text{diagonal lines} \\ \text{diagonal lines} \\ \text{diagonal lines} \\ \text{diagonal lines} \\ \text{diagonal lines} \\ \text{diagonal lines} \\ \text{diagonal lines} \\ \text{diagonal lines} \\ \text{diagonal lines} \end{array}$$

Hence  $g$  is in  $W$  if and only if  $BT^tB$  evaluated at  $g$  is zero, where

$$B = \begin{bmatrix} 1 & & & 0 & y_{1,1} & \cdots & y_{1,p} \\ & 1 & & & \vdots & & \vdots \\ & & \cdot & & \vdots & & \vdots \\ & & & \cdot & \vdots & & \vdots \\ 0 & & & 1 & y_{n-p,1} & \cdots & y_{n-p,p} \end{bmatrix}$$

and  $\{y_{ij}\}$  are affine coordinates in  $\Gamma$ . A straightforward calculation shows that  $BT^tB = (c_{ij})$  is an antisymmetric matrix such that

$$c_{ij} = T_{ij} + f_{ij} \quad 1 \leq i < j \leq n-p$$

where  $f_{ij}$  is a polynomial (of degree 3) depending only on  $\{T_{kl}\}$  for  $l > n-p$  and  $\{y_{kl}\}$ . This means that  $c_{ij}$  are algebraically independent.

Corollary 3.2 The Koszul complex associated with the co-section  $\Lambda^2 F \rightarrow \mathcal{O}_G$

$$L^\bullet : 0 \rightarrow \Lambda^N(\Lambda^2 F) \rightarrow \dots \rightarrow \Lambda^2(\Lambda^2 F) \rightarrow \Lambda^2 F \rightarrow \mathcal{O}_G$$

is locally a free resolution of  $\mathcal{O}_W$  over  $\mathcal{O}_G$ , where  $N = \binom{n-p}{2}$ .

Remark We consider the complex  $L^\bullet$  to be graded by non-positive integers, i.e.  $L^m = \Lambda^{-m}(\Lambda^2 F)$  for  $m \leq 0$ ,  $L^m = 0$  for  $m > 0$ .

**RESOLUTIONS OF DETERMINANTAL VARIETIES**

A spectral sequence of hypercohomology associated with  $\pi$  and  $L^\bullet$

Since  $L^\bullet$  is a (locally free) resolution of  $\mathcal{O}_W$  over  $\mathcal{O}_G$  one of the spectral sequences of hypercohomology of  $\pi$  and  $L^\bullet$  collapses so that the other spectral sequence converges to  $R^n \pi_* \mathcal{O}_W$  :

$$(2) \quad E_1^{m,k} = R^k \pi_* L^m \Rightarrow R^{m+k} \pi_* \mathcal{O}_W .$$

We are going to compute the  $E_1$  term of this spectral sequence in terms of the Schur modules  $S_I E^*$ .

Theorem 3.3 If  $E_1^{m,k} = R^k \pi_* (L^m)$  then

$$E_1^{m,k} = \begin{cases} 0 & , \text{ if } k \neq pt, \quad t \in \mathbb{Z} , \\ \bigoplus_I S_I E^* & , \text{ if } k = pt, \quad t > 0 , \end{cases}$$

where the summation runs over all partitions  $I$  satisfying

- 1)  $m = - |I|/2$
- 2) there exists a partition  $J = (j_1, \dots, j_t)$  s.t.  
 $I = (t+j_1, t+j_2, \dots, t+j_t, \underbrace{t, \dots, t}_{2p+1}, k_1, \dots, k_s)$  where  
 $K = J^\sim = (k_1, \dots, k_s)$  is the conjugate partition of  $J$ .

Remark The diagrams of the partitions  $I$  described above look like:

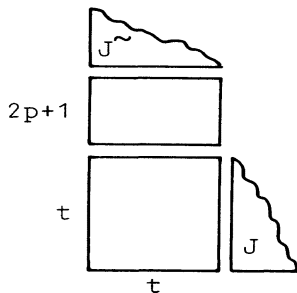

Non-zero modules  $E_1^{m,k}$  lie in the second quadrant, and the first non-zero term (looking from the right) in the row  $pt$  corresponds to a rectangular partition  $(\underbrace{t, \dots, t}_{2p+t+1})$ .

A proof of the theorem will use the Bott theorem and depends heavily on the following combinatorial lemma.

Lemma 3.4 Let  $I$  be a partition

$$(t+j_1, \dots, t+j_t, \underbrace{t, \dots, t}_i, k_1, \dots, k_s)$$

for some partition  $J = (j_1, \dots, j_t)$  and  $K = \tilde{J} = (k_1, \dots, k_s)$ ; i.e. the diagram of  $I$  looks like

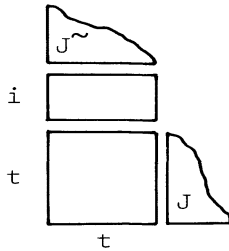

If  $P(0, I)$  is the rectification of the sequence  $(0, i_1, i_2, \dots)$  (see 2.18) then  $P(0, I) = \emptyset$  for  $j_t = 0$ . If  $j_t \neq 0$  then the diagram of  $P(0, I)$  has the form:

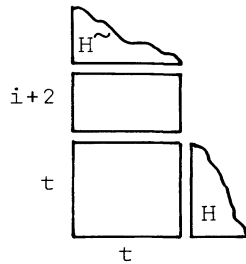

where  $H = (j_1-1, \dots, j_t-1)$ .

*RESOLUTIONS OF DETERMINANTAL VARIETIES*

Proof. Observe that for  $j_t = 0$  the process of rectification of the sequence  $(0, i_1, i_2, \dots)$  leads after  $t-1$  steps to a sequence

$$t+j_1-1, \dots, t+j_{t-1}-1, t-1, t, \dots,$$

which cannot be further rectified because of the interval  $(t-1, t)$ . Therefore by definition  $P(0, I) = \phi$ .

Suppose  $j_t \neq 0$ ; in this case the rectification is possible and a simple calculation shows that the resulting partition is equal to the one described in the lemma.

Proof of Theorem 3.3 It follows from (2.5) that  $L^m = \Lambda^{-m}(\Lambda^2 F)$  =  $\oplus S_I F$  where the sum ranges over all partitions of weight  $-2m$  having diagrams of the form:

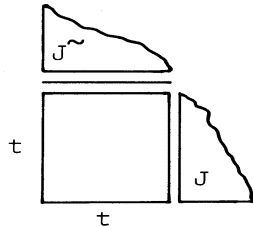

for all possible choices of a natural number  $t$  and a partition  $J$ . To calculate  $R^k \pi_* (S_I F)$  for such  $I$  we use the Bott theorem (2.19) applied to the grassmannian  $G_{n-p}(E^*)$ . This means that we have to compute  $P(\underbrace{0, \dots, 0}_p, I)$ . By iterated use of Lemma 3.4 we get the required result.

Examples 3.5 We illustrate the geography of  $E_1$  for low values of the difference  $n-2p$ . These examples will be treated in more detail in section 5.

Instead of  $S_{\mathbb{I}} \sim E^*$  we write  $I$  for short.

$n-2p = 3$

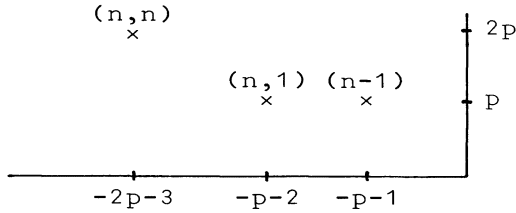

$n-2p = 4$

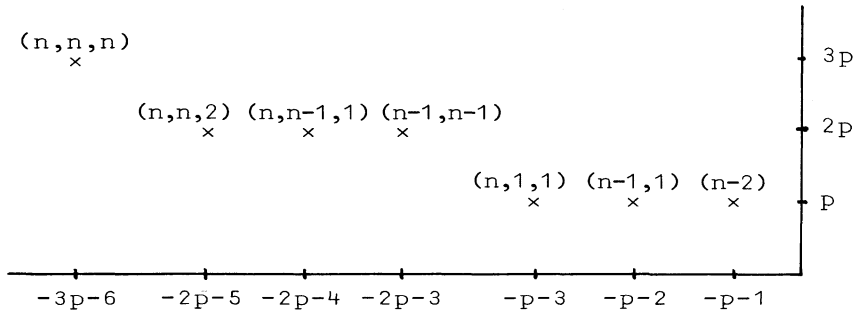

Remark 3.6 The same argument leads to the obvious generalization of Theorem 3.3 for an arbitrary variety  $X$  (over a field of characteristic 0), a vector bundle  $E$  over  $X$ , and an antisymmetric map  $\varphi : E^* \rightarrow E$ , the only hypothesis being that the counterpart of the Koszul complex in Corollary 3.2 be acyclic.

Corollary 3.7  $R^i \pi_* \mathcal{O}_W = 0$  for  $i > 0$ .

Proof. In view of (2) it suffices to show that  $E_1^{m,k} = 0$  for  $m+k > 0$ . As we noticed in the remark following Theorem 3.3 the first non-zero term (from the right) in the row  $pt$  corresponds to the partition  $(\underbrace{t, \dots, t}_{2p+t+1})$  and its coordinates are

$k = pt$ ,  $m = -t(2p+t+1)/2$ . Hence  $m+k = -(t^2+t)/2 < 0$  for  $t > 0$ .

A  $\pi_*$ -acyclic resolution of  $L^\bullet$

We construct here an explicit  $\pi_*$ -acyclic resolution of  $L^\bullet$  which leads directly to the main result of this section.

Consider the map  $E^* \rightarrow Q$  appearing in (1) as a complex with  $E^*$  in degree 0 and  $Q$  in degree 1. Then by Lemma (2.17) we have an exact sequence

$$0 \rightarrow \Lambda^2 F \rightarrow \Lambda^2(E^* \rightarrow Q) \rightarrow 0$$

which looks like

$$(3) \quad 0 \rightarrow \Lambda^2 F \rightarrow \Lambda^2 E^* \rightarrow E^* \otimes Q \rightarrow S_2 Q \rightarrow 0 .$$

Applying Lemma (2.17) once again to (3) we get an exact sequence

$$(4) \quad 0 \rightarrow \Lambda^i(\Lambda^2 F) \rightarrow \Lambda^i[\Lambda^2(E^* \rightarrow Q)] \rightarrow 0 .$$

We are going to define a  $\pi_*$ -acyclic resolution  $D^{\bullet\bullet}$  of  $L^\bullet$ ; to this end we take the complexes (4) as columns, i.e.  $D^{m,\bullet} = \Lambda^{-m}[\Lambda^2(E^* \rightarrow Q)]$ ,  $m \leq 0$ . Pictorially:

$$\begin{array}{ccc} D^{\bullet\bullet} & \dots \rightarrow \Lambda^{-m}[\Lambda^2(E^* \rightarrow Q)] \rightarrow \dots & \\ \uparrow & & \uparrow \\ L^\bullet & \dots \rightarrow \Lambda^{-m}(\Lambda^2 F) \rightarrow \dots & \end{array}$$

To define maps between columns of  $D^{\bullet\bullet}$  we consider the more general situation of a complex  $A^\bullet : A^0 \rightarrow A^1 \rightarrow A^2$  of  $\mathcal{O}_G$ -modules and a cosection  $s : A^0 \rightarrow \mathcal{O}_G$ . We define a map of complexes



$$d_i : \Lambda^i A^\bullet \rightarrow \Lambda^{i-1} A^\bullet$$

as the composition of diagonalisation  $\Lambda^i A^\bullet \rightarrow \Lambda^{i-1} A^\bullet \otimes A^\bullet$  (see [Akin - Buchsbaum - Weyman]) and the map  $\text{id}_{\Lambda^{i-1} A^\bullet} \otimes t$ , where  $t$  is following map of complexes:

$$\begin{array}{ccccccc} A^\bullet & & A^0 & \rightarrow & A^1 & \rightarrow & A^2 \\ \downarrow t & & \downarrow s & & \downarrow & & \downarrow \\ \mathcal{O}_G & & \mathcal{O}_G & \rightarrow & 0 & \rightarrow & 0 \end{array}$$

Lemma 3.8  $d_i \circ d_{i+1} = 0$

Proof. The map  $d_i \circ d_{i+1}$  can be treated as the composition of the natural injection

$$\Lambda^{i+1} A^\bullet \rightarrow \Lambda^{i-1} A^\bullet \otimes A^\bullet \otimes A^\bullet$$

and the map  $A^\bullet \otimes A^\bullet \xrightarrow{t \otimes t} \mathcal{O}_G \otimes \mathcal{O}_G = \mathcal{O}_G$  tensored by the identity on  $\Lambda^{i-1} A^\bullet$ . Using the Littlewood - Richardson rule (or by a straightforward computation) we obtain that the image of  $\Lambda^{i-1} A^\bullet$  under the above mentioned injection is contained in  $\Lambda^{i-1} A^\bullet \otimes \Lambda^2 A^\bullet$ . Since the composition  $\Lambda^2 A^\bullet \rightarrow A^\bullet \otimes A^\bullet \xrightarrow{t \otimes t} \mathcal{O}_G$  is zero, we are done.

Applying this construction to the complex

$$A^\bullet : \Lambda^2 E^\bullet \rightarrow E^\bullet \otimes Q \rightarrow S_2 Q$$

and the cosection  $\varphi : \Lambda^2 E^\bullet \rightarrow \mathcal{O}_G$ , we get a double complex  $D^{\bullet\bullet}$ .

Corollary 3.9 The complex  $D^{\bullet\bullet}$  is a  $\pi_*$ -acyclic resolution of  $L^\bullet$ .

Proof. Each column  $D^{m, \bullet}$  of  $D^{\bullet}$  is a resolution of  $L^m$  in view of the exactness of (3). Moreover each component of  $D^{m, \bullet}$  is a direct sum of modules of the form  $S_I E^* \otimes S_J Q$  for some partitions  $I, J$ . Since  $S_J Q$  are  $\pi_*$ -acyclic by the Bott theorem (2.19) we infer that  $D^{m, \bullet}$  is a  $\pi_*$ -acyclic resolution.

Corollary 3.10 The only non-zero homology of the complex  $D^\bullet = \text{tot } D^{\bullet}$  is in degree zero and equals  $0_W$ .

Proof This follows from 3.9 and the fact that  $L^\bullet$  is a resolution of  $0_W$  over  $0_G$ .

A resolution of  $0_{Y_{2p}}$  over  $0_X$

We define  $C^{\bullet} = \pi_*(D^{\bullet})$ ;  $C^{\bullet}$  is a double complex of free  $0_X$ -modules.

Corollary 3.11 The only non-zero homology of  $C^\bullet = \text{tot } C^{\bullet}$  is in degree zero and is equal to  $R^0 \pi_* 0_W$ .

Proof We get the required result by standard arguments with spectral sequences using 3.10 and  $\pi_*$ -acyclicity of  $D^{\bullet}$ .

From the definition of  $D^{\bullet}$  and the Bott theorem it follows that each component of  $C^{\bullet}$  is a direct sum of tensor products of Schur modules on  $E^*$ .

Lemma 3.12 For each  $m$  the differentials of the complex  $C^{m, \bullet}$  are natural with respect to  $E^*$ . In particular they are morphisms of  $GL(U)$ -modules.

Proof A commutative diagram of  $\mathcal{O}_G$ -modules

$$\begin{array}{ccc} E^* & \xrightarrow{\text{id}} & E^* \\ \text{id} \downarrow & & \downarrow \rho \\ E^* & \xrightarrow{\rho} & Q \end{array}$$

(see (1) for the definition of  $\rho$ ) induces a surjective morphism of complexes

$$(5) \quad \begin{array}{c} \Lambda^{-m}[\Lambda^2(E^* \rightarrow E^*)] \\ \downarrow \\ \Lambda^{-m}[\Lambda^2(E^* \rightarrow Q)] \end{array}$$

Using (2.16) and (2.7), the plethysm formulas (2.3 - 2.6) and the Littlewood - Richardson rule, one can write (5) in the form

$$(6) \quad \begin{array}{ccc} \dots \rightarrow \oplus S_I E^* \otimes S_J E^* \rightarrow \dots & & \\ & \downarrow \text{id} \otimes S_J(\rho) & \\ \dots \rightarrow \oplus S_I E^* \otimes S_J Q \rightarrow \dots & & \end{array}$$

Recall (2.19) that

$$\pi_*(S_J(\rho)) = \begin{cases} S_J(E^*) \xrightarrow{\text{id}} S_J(E^*) & \text{if } \text{lg}(J) \leq p \\ 0 & \text{if } \text{lg}(J) > p \end{cases}$$

Hence by applying  $\pi_*$  to (6) we get a surjective map of complexes

$$\begin{array}{ccc} \Lambda^{-m}(\Lambda^2(E^* \xrightarrow{\text{id}} E^*)) & \dots \rightarrow \oplus S_I E^* \otimes S_J E^* \rightarrow \dots & \\ \downarrow & & \downarrow \\ C^{m, \cdot} & \dots \rightarrow \oplus_{\text{lg} J \leq p} S_I E^* \otimes S_J E^* \rightarrow \dots & \end{array}$$

Therefore  $C^{m, \cdot}$  has a natural differential as a quotient of  $\Lambda^{-m}[\Lambda^2(E^* \xrightarrow{\text{id}} E^*)]$ .

Now we are going to compute  $R^0 \pi_* \mathcal{O}_W$  by using a spectral sequence associated with the double complex  $C^{\bullet\bullet}$ . Since  $D^{m,\bullet}$  is a  $\pi_*$ -acyclic resolution of  $L^m$  we have  $R^k \pi_*(L^m) = H^k(C^{m,\bullet})$ . Therefore the first term of such a spectral sequence is equal to that of the spectral sequence (2) of hypercohomology. From Theorem 3.3 it follows that there is exactly one non-zero term on each of the lines  $m+k = 0, -1, -2$  as indicated on the picture below

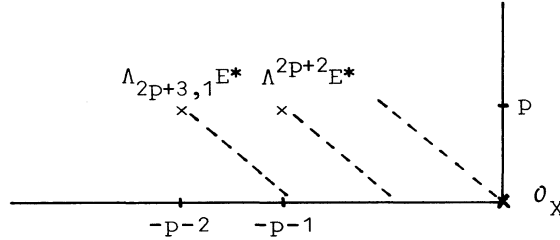

Therefore

$$E_2^{-(p+1),p} = \Lambda^{2p+2} E^* / \text{Im}(\Lambda_{2p+3,1} E^* \rightarrow \Lambda^{2p+2} E^*)$$

and  $E_2^{-(p+1),p} = \dots = E_{p+1}^{-(p+1),p}$ . Since  $E_\infty^{-(p+1),p} = 0$ , in view of Corollary 3.7, we infer that:

$$E_{p+1}^{-(p+1),p} \xrightarrow{d_{p+1}} E_{p+1}^{0,0} = 0_X$$

is an injection. Observe that  $S_I E = S_I U \otimes_K \mathcal{O}_X$  and  $\mathcal{O}_X = \bigoplus (\mathcal{O}_X)_i$  is a graded ring where  $(\mathcal{O}_X)_i = S_i(\Lambda^2 U)$ . Therefore  $S_I E$  is a graded module over  $\mathcal{O}_X$  and the differentials of  $C^{\bullet\bullet}$  (both vertical and horizontal) are maps of graded  $\mathcal{O}_X$ -modules and are

natural with respect to  $U$ . Moreover the horizontal differentials are homogeneous  $\mathcal{O}_X$ -homomorphisms of degree 1. All this implies that  $E_{p+1}^{-(p+1),p}$  is generated by  $\Lambda^{2p+2}U$  over  $\mathcal{O}_X$  and therefore the zero component of  $d_{p+1} : E_{p+1}^{-(p+1),p} \rightarrow \mathcal{O}_X$  is, up to a scalar, defined by the map  $\text{Pf}$ . This scalar must be non-zero since  $d_{p+1}$  is injective. Hence  $\text{Im } d_{p+1} = \text{Pf}_{2p+2}(\varphi)$  and  $R^0\pi_*\mathcal{O}_W = E_\infty^{0,0} = \mathcal{O}_{Y_{2p}}$ . This together with Corollary 3.7 gives us

Proposition 3.13  $R^i\pi_*\mathcal{O}_W = 0$  for  $i > 0$ ,  $R^0\pi_*\mathcal{O}_W = \mathcal{O}_{Y_{2p}}$ .

Therefore by [Kempf]  $Y$  is a normal, Cohen - Macaulay variety.

Now we are ready to prove the main theorem of this section.

Theorem 3.14 The  $i$ -th component of a minimal free resolution of  $\mathcal{O}_{Y_{2p}}$  over  $\mathcal{O}_X$  is equal to

$$\oplus S_I E^*$$

where the sum ranges over all partitions  $I$  satisfying 1), 2) of Theorem 3.3 with  $m+k = i$ ,  $m = -|I|/2$ , and  $k = p \cdot \text{rank } (I)$ .

Proof Recall that the  $i$ -th component  $F^i$  of a minimal free resolution is isomorphic to  $\text{Tor}_{-i}^{\mathcal{O}_X}(\mathcal{O}_{Y_{2p}}, \mathcal{O}_X/(\mathcal{O}_X)_+) \otimes_{\mathcal{O}_X} \mathcal{O}_X$ , where  $(\mathcal{O}_X)_+$  is the ideal in  $\mathcal{O}_X$  generated by the elements of positive degree. Since  $C^\bullet$  is an acyclic complex of free  $\mathcal{O}_X$ -modules with  $H^0(C^\bullet) = \mathcal{O}_{Y_{2p}}$  by 3.13 and 3.11 we have

$$F^i = H^i(C^\bullet \otimes_{\mathcal{O}_X} \mathcal{O}_X/(\mathcal{O}_X)_+) \otimes_{\mathcal{O}_X} \mathcal{O}_X.$$

However  $C^\bullet = \text{tot } C^{\bullet\bullet}$  and horizontal differentials in  $C^{\bullet\bullet}$  are  $\mathcal{O}_X$ -homomorphisms of degree 1. Therefore  $H^i(C^\bullet \otimes_{\mathcal{O}_X} \mathcal{O}_X/(\mathcal{O}_X)_+)$  is

**RESOLUTIONS OF DETERMINANTAL VARIETIES**

a sum of the corresponding homology of columns  $C^{m,*} \otimes \mathcal{O}_X / (\mathcal{O}_X)_+$ , which were computed in Theorem 3.3 (see Remark 3.6).

Corollary 3.15  $Y_{2p}$  is a Gorenstein variety.

Proof The last non-zero component in 3.14 is  $\Lambda_{\underbrace{n, \dots, n}_{n-2p+1}}^{E^*}$ , which is of rank 1.

Corollary 3.16 Since  $Y_2$  is a cone over a grassmannian  $G_2(n)$ , Theorem 3.14 gives all components of a minimal free resolution of  $G_2(n)$  in this case (via the Plücker embedding).

Now we are going to discuss differentials in a minimal resolution of  $\mathcal{O}_{Y_{2p}}$  over  $\mathcal{O}_X$ .

Lemma 3.17 Let  $S_I E^*, S_L E^*$  be direct summands of  $F^i$  and  $F^{i+1}$ , respectively, and  $I \supset L$ . If the diagrams of  $I$  and  $L$  are as in the picture below

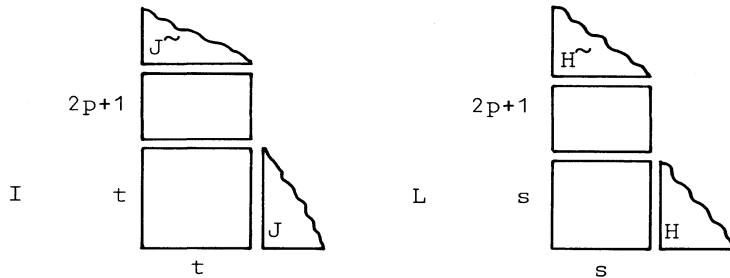

then either

$$1^\circ \quad t = s, \quad |J| = |H| + 1$$

or

$$2^\circ \quad t = s + 1, \quad |H| = |J| + t - 1 \quad \text{and} \quad h_k = j_k + 1$$

for  $1 \leq k \leq s$ ,  $j_t = 0$ .

Proof It follows from  $I \supset L$  that  $s \leq t$  and  $h_k \leq j_k + x$  where  $x = t - s$ . Therefore  $|H| \leq |J| + sx$ . Since  $|J| + t(t+1)/2 = |H| + s(s+1)/2 + 1$  we find that  $x^2 + x - 2 \leq 0$ . We have therefore two possibilities  $x = 0$ ,  $x = 1$  which correspond to  $1^0$  and  $2^0$  of the lemma.

Remark 3.18 In the case  $2^0$   $I$  and  $L$  differ in one column only by  $2p+2$  squares.

Let  $d_i : F^i \rightarrow F^{i+1}$  be the differentials in our minimal resolution. These are  $\mathcal{O}_X$  morphisms which are natural with respect to  $U$ . This together with the Littlewood - Richardson rule implies that the restriction  $S_I E^* \rightarrow S_L E^*$  of  $d_i$  is zero if  $I \not\supset L$ . If  $I \supset L$  then  $S_I E^* \rightarrow S_L E^*$  (if non-zero) is an  $\mathcal{O}_X$ -map of degree 1 in the case  $1^0$  of Lemma 3.17 and of degree  $p+1$  in the case  $2^0$ . Moreover in the latter case it is described by  $2p+2$ -pfaffians of  $\varphi$  (in view of Remark 3.18).

#### B. Symmetric matrices

From now on let  $X = \text{Sym}_n K$  be the affine space of all symmetric  $n \times n$  matrices over a field  $K$ . We can identify  $X$  with  $S_2 V$  where  $V$  is a vector space of dimension  $n$  over  $K$ . For  $U = V^*$  the symmetric algebra  $S_*(S_2 U)$  can be treated as the coordinate ring  $\mathcal{O}_X$  of  $X$ .

Let  $E$  be a trivial vector bundle on  $X$ . The canonical section of  $S_2 E$  induces a generic symmetric morphism  $\varphi : E^* \rightarrow E$ . If  $\{v_i\}$  is a basis of  $V$ ,  $\{v_i^*\}$  its dual basis of  $U$  and  $T_{ij} = v_i^* v_j^* \in S_2 U$ , then  $T = (T_{ij})$  is the matrix of  $\varphi$  with respect to  $\{v_i^*\}$  and  $\{v_i\}$ . The ideal  $I_{r+1}(\varphi)$  generated by all the  $(r+1)$ -order minors of  $T$  is equal to the ideal

generated in  $S_*(S_2U)$  by  $\Lambda_{r+1,r+1}U$ . Observe that  $\Lambda_{r+1,r+1}U$  is contained in  $S_{r+1}(S_2U)$  in view of (2.3). We write  $Y_r$  for the subvariety of  $X$  corresponding to  $I_{r+1}(\varphi)$ .

The main result of this section is

Theorem 3.19 The  $i$ -th component of a minimal free resolution  $0_{Y_r}$  over  $0_X$  is equal to

$$\bigoplus_{m+k=i} S_I E^*$$

where the sum ranges over all partitions  $I$  of the following shape:

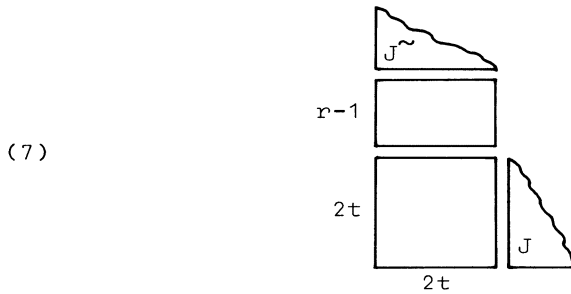

and  $m = -|I|/2$ ,  $k = (r/2)rk(I)$ .

This means that there exists a partition  $J = (j_1, \dots, j_{2t})$ ,  $K = \tilde{J} = (k_1, \dots, k_s)$  such that

$$I = (2t+j_1, \dots, 2t+j_{2t}, \underbrace{2t, \dots, 2t}_{r-1}, k_1, \dots, k_s) .$$

In particular the first component of the resolution is equal to  $\Lambda_{r+1,r+1}E^*$ .

At first we will study the ideals of odd order minors, say,  $r = 2p$ .



Consider a relative grassmannian  $G = G_{n-p}(E^*) \xrightarrow{\pi} X$  with a tautological sequence  $0 \rightarrow F \xrightarrow{\eta} E^* \rightarrow Q \rightarrow 0$  on  $G$ .

We have the following symmetric morphism

$$\tilde{\varphi} : F \xrightarrow{\eta} E^* \xrightarrow{\varphi} E \xrightarrow{\eta^*} F^*$$

which induces a cosection  $S_2F \rightarrow \mathcal{O}_G$ . Let  $W$  be the subvariety of zeros of this cosection, i.e.

$$\mathcal{O}_W = \text{Coker}(S_2F \rightarrow \mathcal{O}_G)$$

Similarly as in Lemma 3.1 we prove that  $\pi(W) \subset Y_r$  and  $W$  is locally a complete intersection in  $G$  of codimension  $\binom{n-p+1}{2}$ . Therefore the Koszul complex

$$L^\bullet : \dots \rightarrow \Lambda^2(S_2F) \rightarrow S_2F \rightarrow \mathcal{O}_G \rightarrow 0$$

is locally a free  $\mathcal{O}_G$ -resolution of  $\mathcal{O}_W$ . Let  $D^{\bullet\bullet}$  denote a  $\pi_*$ -acyclic resolution of the Koszul complex  $L^\bullet$ :

$$\begin{array}{ccc} D^{\bullet\bullet} & \dots \rightarrow \Lambda^{-m}[S_2(E^* \rightarrow Q)] \rightarrow \dots \\ \uparrow & \uparrow \\ L^\bullet & \dots \rightarrow \Lambda^{-m}(S_2F) \rightarrow \dots \end{array}$$

defined by exactly the same method as in part A. As in A. the total complex  $D^\bullet$  of  $D^{\bullet\bullet}$  has only one non-zero homology  $H^0(D^\bullet) = \mathcal{O}_W$ . Let  $C^{\bullet\bullet} = \pi_*(D^{\bullet\bullet})$  and let  $C^\bullet$  be a total complex of  $C^{\bullet\bullet}$ .

Using the Bott theorem we are able to compute the cohomology of columns in  $C^{\bullet\bullet}$ .

Theorem 3.20 The first term  $E_1^{m,k} = R^k \pi_*(L^m)$  of a spectral sequence of hypercohomology associated with  $L^{\bullet\bullet}$  and  $\pi_*$  can be described as follows:

*RESOLUTIONS OF DETERMINANTAL VARIETIES*

$$E_1^{m,k} = \begin{cases} 0 & \text{if } k \neq pt, \\ \bigoplus S_I E^* & \text{if } k = pt, \quad t > 0, \end{cases}$$

where the sum runs over all partitions  $I$  satisfying

- 1)  $m = -|I|/2$
- 2) There exists a partition  $J = (j_1, \dots, j_t)$ , such that  $I = (t+j_1, \dots, t+j_t, \underbrace{t, \dots, t}_{r-1}, k_1, \dots, k_s)$  where  $K = \tilde{J} = (k_1, \dots, k_s)$  is the conjugate partition of  $J$ .

Remark The diagrams of the partitions  $I$  described above look like:

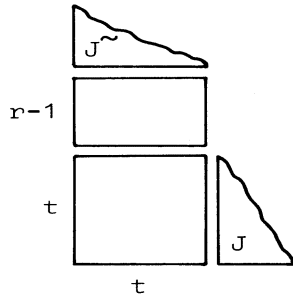

To prove this theorem we use the plethysm formula (see (2.6))  $\Lambda^{-m}(S_2 F) = \bigoplus S_I F$ , where  $I$  runs over the set of all partitions of weight  $-2m$ , rank  $t$ , and the following shape

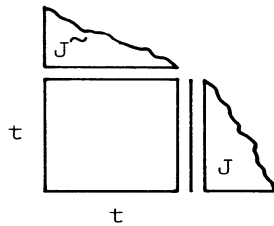

and we proceed exactly as in Lemma 3.4.

By analyzing the geography of  $E_1^{m,k}$  similarly as in Corollary 3.7 we get:

Corollary 3.21  $R^i \pi_* \mathcal{O}_W = 0$  for  $i > 0$ .

To compute  $R^0 \pi_* \mathcal{O}_W$  observe that (by Theorem 3.20) the only non-zero terms on the lines  $m+k = 0$ ,  $m+k = -1$ ,  $m+k = -2$  are  $\mathcal{O}_X, \Lambda^r E^*$ ;  $\Lambda_{r+1,1} E^*, \Lambda_{r+1,r+1} E^*$ ;  $\Lambda_{r+2,1,1} E^*, \Lambda_{r+2,r+1,1,1} E^*$ , respectively (see the picture below)

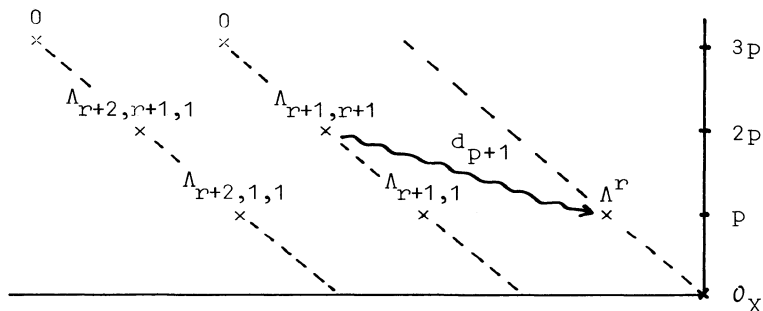

Therefore

$$E_\infty = E_\infty^{0,0} \oplus E_\infty^{-p,p}$$

Using the naturality of the differentials (with respect to  $U$ ) and the fact that  $\Lambda_{r+1,r+1} U$  doesn't appear as a summand in  $\Lambda^r U \otimes S_{p+1}(S_2 U)$  (by the Littlewood - Richardson rule) we conclude that the differential  $d_{p+1}$  marked on the picture vanishes. Therefore  $E_\infty^{-p,p} = E_1^{-p,p} = \text{Coker}(\Lambda_{r+1,1} E^* \xrightarrow{d_1} \Lambda^r E^*)$  where  $d_1$  is the first differential of the spectral sequence. The above remark shows that:

$$E_\infty^{-(r+1),r} = \text{Ker}(E_{r+1}^{-(r+1),r} \xrightarrow{d_{r+1}} \mathcal{O}_X)$$

where  $E_{r+1}^{-(r+1),r} = \text{Coker} (\Lambda_{r+2,r+1,1} E^* \xrightarrow{d_1} \Lambda_{r+1,r+1} E^*)$ . But  $E_{\infty}^{-(r+1),r} = 0$  so that  $d_{r+1}$  is an injection. Note that  $E_{r+1}^{-(r+1),r}$  is generated as a graded  $\mathcal{O}_X$ -module by the 0-th component  $\Lambda_{r+1,r+1} U$ . Since every natural map  $\Lambda_{r+1,r+1} U \rightarrow S_{r+1}(S_2 U)$  is up to a scalar determined by  $(r+1)$ -order minors of  $\varphi$ , we obtain  $E_{\infty}^{0,0} = \mathcal{O}_Y$  and hence:

Lemma 3.22  $R^0 \pi_* \mathcal{O}_W = \mathcal{O}_{Y_r} \oplus M$ , where  $M = E_{\infty}^{-p,p}$

Corollary 3.23 The only non-zero homology of  $C^\bullet$  appears in degree zero and is equal to  $\mathcal{O}_{Y_r} \oplus M$ .

Recall that our main aim is to compute

$F^i = \text{Tor}_{-i}^{\mathcal{O}_X}(\mathcal{O}_{Y_r}, \mathcal{O}_X / (\mathcal{O}_X)_+) \otimes_K \mathcal{O}_X$  where  $(\mathcal{O}_X)_+$  is the ideal of  $\mathcal{O}_X$  generated by homogenous elements of positive degree. By Theorem 3.20 and Corollary 3.23 we infer that

$$(8) \quad F^i \otimes \text{Tor}_{-i}^{\mathcal{O}_X}(M, \mathcal{O}_X / (\mathcal{O}_X)_+) = \otimes S_I U$$

where  $I$  runs over all partitions satisfying 1), 2) of Theorem 3.20 such that  $m+k=i$ ,  $m = -|I|/2$ ,  $k = p \text{ rk}(I)$ . Observe that the partitions (7) are among those specified above. Hence to prove Theorem 3.19 it suffices to show that all the partitions (7) really do appear in the decomposition of  $F^i$  and none of the remaining summands of (8) can appear in  $F^\bullet$ . To achieve this goal we construct another free  $\mathcal{O}_X$ -resolution of  $\mathcal{O}_{Y_r}$  (it appears already in [Lascoux]) by a method similar to that used in the construction of  $C^\bullet$ .

Recall that  $X = S_2 V$  where  $V$  is a vector space over  $K$  of dimension  $n$ . Let  $V'$  be a subspace of  $V$  of dimension  $r$

and denote by  $P$  the parabolic subgroup of  $GL(V)$  stabilizing  $V'$  in  $V$ . We have a diagram (see [Kempf])

$$\begin{array}{ccc} Z = GL(V) \times^P S_2 V' & \xrightarrow{\tau} & S_2 V \\ \downarrow & & \downarrow \\ & & GL(V)/P \end{array}$$

where  $Z$  is a homogenous bundle on  $G_r(V) = GL(V)/P$  and  $\tau$  is defined by  $\tau(g, v_1 v_2) = (g v_1)(g v_2)$ . It is easy to show that  $\tau(Z) = Y$  (in fact  $\tau$  is a birational morphism). If we consider a relative grassmannian  $G_r(E)$  and a tautological subbundle  $R$ , then  $Z$  is isomorphic to the subvariety of  $G_r(E)$  which is locally a complete intersection defined by the section  $\mathcal{O}_{G_r(E)} \rightarrow N = \text{Coker}(S_2 R \rightarrow S_2 E)$  or equivalently by a cosection  $N^* \rightarrow \mathcal{O}_{G_r(E)}$ . Hence the Koszul complex of  $N^* \rightarrow \mathcal{O}_{G_r(E)}$  is locally a free resolution of  $\mathcal{O}_Z$  over  $\mathcal{O}_{G_r(E)}$ . We define its  $\pi_*$ -acyclic resolution  $B^{\bullet}$  by putting  $B^{m, \bullet} = \Lambda^{-m}(S_2 E^* \rightarrow S_2 R^*)$  for  $m \leq 0$  and defining horizontal differentials  $B^{m, \bullet} \rightarrow B^{m+1, \bullet}$  in an obvious way. By similar arguments as before with respect to  $C^{\bullet}$  we infer that the total complex of  $A^{\bullet} = \tau_*(B^{\bullet})$  is a free  $\mathcal{O}_X$ -resolution of  $\mathcal{O}_{Y_r}$ .

Since by the Bott theorem  $R^0 \tau_* S_I R^* = S_I E^*$  if  $lg I \leq r$  and zero otherwise, we can write explicitly:

$$A^{m, k} = \bigoplus S_L E^* \oplus S_H E^* \quad m \leq 0, \quad k \geq 0$$

where the sum ranges over  $L \in L_{-m-k}$ ,  $H \in H_k$ . Here  $L_i$  denotes the set of partitions  $L$  appearing in the plethysm formula  $\Lambda^i(S_2) = \bigoplus_L S_L$  (see (2.6)) and  $H_i$  is a set of partitions  $H$  with the following properties

- (a)  $|H| = 2i$
- (b) The length of each part of  $H$  is even.
- (c) The length of  $H$  is at most  $r$ .

Remark The fact that the Schur functors occurring in the resolution of  $\mathcal{O}_{Y_r}$  over  $\mathcal{O}_X$  are the ones occurring in the cohomology of the column  $A^{m, \bullet}$  can be shown in another way. Recall that the  $i$ -th module in the minimal free resolution of  $\mathcal{O}_{Y_r}$  over  $\mathcal{O}_X$  is just

$$\mathrm{Tor}_i^{\mathcal{O}_X}(\mathcal{O}_{Y_r}, \mathcal{O}_X / (\mathcal{O}_X)_+) \otimes_K \mathcal{O}_X$$

Observe that the Tor written above is just a  $K$ -vector space. But  $\mathrm{Tor}^{\mathcal{O}_X}(\mathcal{O}_{Y_r}, \mathcal{O}_X / (\mathcal{O}_X)_+)$  can be computed as the cohomology of the Koszul complex  $\Lambda^*(S_2 E^*)$  tensored with  $\mathcal{O}_{Y_r}$  over  $\mathcal{O}_X$ . This cohomology is annihilated by  $(\mathcal{O}_X)_+$ , so we can compute it in each homogeneous component separately. We see that each homogeneous component is just a column of  $A^{\bullet, \bullet}$ . It follows immediately from the decomposition

$$[S_*(S_2 U) / I_{r+1}(\varphi)]_t = \sum_{\substack{||I||=2t \\ I \text{ has even rows} \\ i_1 \leq r}} \Lambda_I U$$

In view of the previous remarks the following proposition allows us to complete the proof of Theorem 3.19.

Proposition 3.24 Let  $I$  be a partition of weight  $-2m$ , rank  $s$  and with a diagram of the form

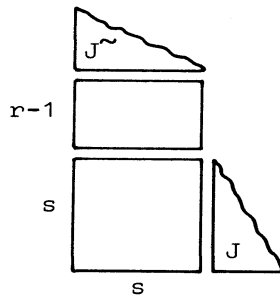

for some partition  $J$ . Then  $S_{\perp}E^*$  appears in the cohomology of  $A^{m, \bullet}$  if and only if  $s$  is even.

Remark The proposition is valid for arbitrary  $r$  (not necessarily even).

Before starting with a proof of 3.24 we state the following easy consequence of the Littlewood - Richardson rule.

Lemma 3.25 Let  $H, L$  be arbitrary partitions and let  $P = (h_1+1, h_2+1, \dots)$ . Then  $\Lambda_P$  appears with multiplicity 1 in  $\Lambda_H \otimes \Lambda_L$ .

In the sequel we write  $P$  for short instead of  $S_P E$ .

Proof of Proposition 3.24

1)  $s = 2t$

First we treat the case when the length of the first column in  $J$  is equal to  $2t$ . Consider three components of the complex  $A^{m, \bullet}$  involved in the proof

$$A^{m, 2tr-1}, A^{m, 2tr}, A^{m, 2tr+1}$$

and write

$$L_0 = (2t+1+j_1, 2t+1+j_2, \dots, 2t+1+j_t, \tilde{j}_1, \dots, \tilde{j}_q) \in L_{-m-tr}$$

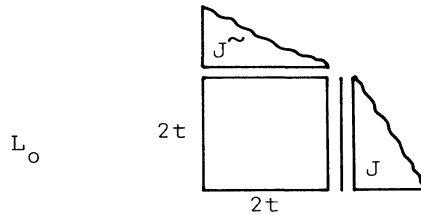

$$\text{and } H_0 = (\underbrace{\dots}_{2t}, \dots, r) \in H_{tr}.$$

**RESOLUTIONS OF DETERMINANTAL VARIETIES**

We are going to prove that  $I$  occurs in  $A^{m, 2tr}$  with multiplicity 1 as a summand in the product  $L_0 \otimes H_0$  and  $I$  occurs with multiplicity 0 both in  $A^{m, 2tr-1}$  and  $A^{m, 2tr+1}$ . Since  $A^{m, \cdot}$  is a complex of Schur modules with natural differentials this would imply that it occurs in  $H^{2tr}(A^{m, \cdot})$ . It follows from Lemma 3.25 that  $I$  really appears in  $L_0 \otimes H_0$  with multiplicity 1. Suppose  $I$  occurs as a summand of  $L \otimes H$  where  $(L, H) \in L_{-m-tr-1} \times H_{tr+1}$  or  $(L, H) \in L_{-m-tr+1} \times H_{tr-1}$ . Observe first that the length of the arm of any diagonal square of  $L$  can not be greater than the length of the arm of the corresponding diagonal square in  $I$ , if  $I$  really occurs in  $L \otimes H$ ; therefore  $L \subset L_0$ , and  $L \notin L_{-m-tr+1}$ . Let us assume  $L \in L_{-m-tr-1}$ . Observe that to obtain  $I$  from  $L$  and  $H$  (using the Littlewood - Richardson rule)

we must add a column of symbols to each of the first  $2t$  columns in  $L$ . Since  $|H| = 2tr+2$  and the length of each part

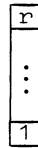

of  $H$  is even we conclude that  $H = (2t+2, \underbrace{2t, \dots, 2t}_{r-1})$ . But  $L$  differs from  $L_0$  by two squares of which at most one lies on the right of the  $2t$ -th column of  $L$ . To obtain  $I$  from  $L$  and  $H$  we must write the symbol  $\boxed{1}$  twice on the right of the  $2t$ -th column of  $L$ . Hence we cannot obtain  $I$ , and we are done.

If the length of the first column in  $J$  is less than  $2t$  the argument is similar. In this case:

$$L_0 = (j_1+2t, \dots, j_{2t-1}+2t, \tilde{j}_1, \dots, \tilde{j}_q)$$



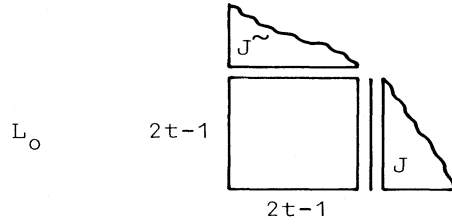

and  $H_0 = (\underbrace{r, \dots, r}_{2t})$ .

2) Suppose now that the rank of  $I$  is odd, and  $I$  appears as a summand in the product  $L \otimes H$  where  $L \in L_{-m-tr}$ ,  $H \in H_{tr}$  for some  $t$ . Observe that for each diagonal square of  $I$  the difference between the length of its neck and arm is  $r-1$  while for each diagonal square of  $L$  this difference equals  $-1$ . Let a diagram of  $L$  be of the form

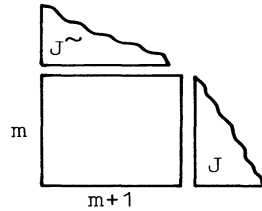

A moment of reflection shows that the only way to get  $I$  from  $L$  by adding numbered squares from some partition  $H \in H_{tr}$  in such a way that the resulting word is a lattice permutation, is for  $H = (\underbrace{m+1, \dots, m+1}_r)$ . The resulting partition is therefore of the form

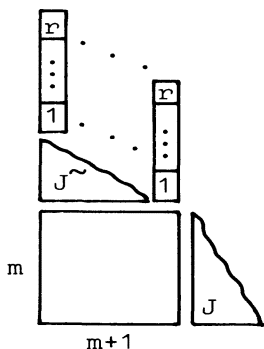

Since  $H \in H_i$  the rank of the above partition is even. This gives us a contradiction because we assumed that the rank of  $I$  is odd.

Now let us treat  $(r+1)$ -order minors when  $r+1$  is even. By Proposition 3.24 we know that also in this case all Schur modules  $S_{\mathbb{I}}E^*$  corresponding to partitions (7) do appear as summands with multiplicity 1 in the minimal resolution of  $\mathcal{O}_{Y_r}$  over  $\mathcal{O}_X$ . We are going to show that these are the only summands.

Consider the affine space  $X'$  of all symmetric  $n+1$  by  $n+1$  matrices over  $K$  and its coordinate ring  $\mathcal{O}_{X'} = K[T'_{ij}]$   $1 \leq i \leq j \leq n+1$ . Write  $E'$  for a trivial vector bundle of rank  $n+1$  over  $X'$  and  $\varphi' : E'^* \rightarrow E'$  for the generic symmetric morphism which in some basis of  $E'$  and its dual basis of  $E'^*$  is determined by the symmetric matrix  $(T'_{ij})$ .

By the previous considerations all components of the minimal resolution  $F^*(\varphi')$  of  $\mathcal{O}_{X'}/I_{r+2}(\varphi')$  over  $\mathcal{O}_{X'}$  are known.

Let  $G^*$  be the complex  $F^*(\varphi')$  localised at the powers of  $T'_{n+1,n+1}$ . It is obvious that  $G^*$  is a resolution of  $\mathcal{O}/I_{r+2}(\varphi'')$  over  $\mathcal{O}$  where  $\varphi''$  is the matrix:

$$\left( \begin{array}{c|c} \varphi & 0 \\ \hline 0 & 1 \end{array} \right)$$

and  $0 = (0_X, \{T'_{n+1, n+1}\})$ . Consider the ring homomorphism:

$$f : 0 \rightarrow 0_X,$$

$$f(T'_{i,j}) = \begin{cases} T_{i,j} & \text{for } 1 \leq i \leq j \leq n \\ 0 & \text{for } j=n+1, i=1, \dots, n \\ 1 & \text{for } i=j=n+1 \end{cases}$$

Observe that  $f(I_{r+2}(\varphi'')) = I_{r+1}(\varphi)$  and  $\text{length } G^* = \text{length } F^*(\varphi')$   
 $= 1/2[n+1-(r+2)+1][n+1-(r+2)+2] = 1/2[n-(r+1)+1][n-(r+1)+2]$   
 $= \text{depth}(I_{r+1}(\varphi), 0_X)$  by [Kutz]. In view of Corollary 8 in [Kempf - Laksov] we see that  $H^* = G^* \otimes_{0_X} 0_X$  is a free resolution (non-minimal) of  $0_X/I_{r+1}(\varphi)$  over  $0_X$ . We are going to use this resolution to investigate

$$(9) \quad \text{Tor}_{-i}^{0_X}(0_X/I_{r+1}(\varphi), 0_X/(0_X)_+) \otimes_K 0_X$$

Observe that the complex  $\bar{H}^* = H^* \otimes_{0_X} 0_X/(0_X)_+$  is a complex of  $GL(U)$ -modules and is equal to  $F^*(\psi) \otimes_{0_X} (0_X/(0_X)_+)$  where  $\psi$  is the following map of  $0_X$ -modules:

$$\psi : E^* \otimes_{0_X} \xrightarrow{0 \oplus \text{id}} E \otimes_{0_X}$$

Observe that  $S_P E^*$  appears as a summand in (9) if and only if  $S_P U$  is a summand in the  $i$ -th cohomology of  $\bar{H}^*$ , and recall that  $S_P E^*$  appears in (9) if and only if  $S_P E^*$  is a summand in the cohomology of  $H^k(A^{m,*})$  for  $m = -|P|/2$ ,  $k = -m+i$ .

Therefore it suffices to show that if  $S_P U$  appears in  $\bar{H}^i$ , and is not of the form (7), then  $S_P E^*$  cannot appear in  $A^{m,k}$ .

Let  $I$  be a partition such that  $S_I E'^*$  occurs in  $F^i(\varphi')$ . Since  $r+2$  is odd we know already that  $I$  has a diagram of the form

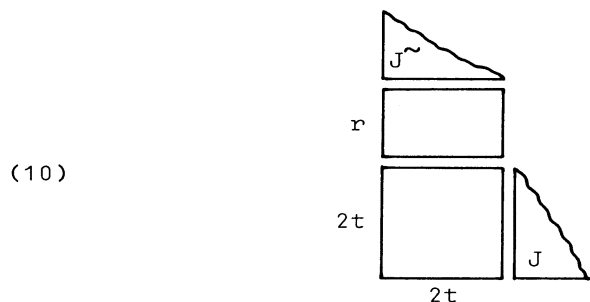

By the formula (2.10) and the linearity formula (2.2) we have

$$(11) \quad S_I(E^* \oplus \mathcal{O}_X) = \oplus S_N E^*$$

where the sum ranges over all partitions  $N$  contained in  $I$  such that  $I/N$  has at most one square in each column.

Removing one square from each of the first  $2t$ -columns of  $I$  we get a partition  $I_0$  of the form (7). Therefore the following lemma completes our proof of Theorem 3.19 if  $r+1$  is even.

Lemma 3.26 Let  $I$  be a partition with a diagram (10). Then among the partitions  $N$  occurring in the sum (11)  $I_0$  is the only one occurring as a summand of a component of the double complex  $A''$ .

Proof We are going to prove that if  $N$  appears in (11) and  $N$  occurs in  $L \oplus H$  for  $L \in L_{-m-i}$ ,  $H \in H_i$  then  $N = I_0$ .

First observe that the largest difference between the length of the neck and the arm of any diagonal square of a

partition obtained as a result of tensoring two elements from  $L_{-m-i}$  and  $H_i$  is equal  $n-1$ . This follows from the description of the Littlewood - Richardson rule in terms of lattice permutations.

On the other hand each  $N \neq I_0$  occurring in (11) has the property that there exists a diagonal square in  $N$  having the difference between lengths of its neck and arm larger than  $r$ . Hence our claim follows.

Corollary 3.27 The determinantal variety  $Y_r$  is Gorenstein if and only if  $n-r$  is odd.

Proof It follows from Theorem 3.19 that the last module in a minimal resolution of  $\mathcal{O}_{Y_r}$  over  $\mathcal{O}_X$  is equal to:

$$\begin{cases} S_{(n-r+1)^n} (E^*) & , \text{ if } n-r \text{ is odd} \\ S_{(n-r+1)^{n-r} (n-r)^r} (E^*) & , \text{ if } n-r \text{ is even} \end{cases}$$

Since this module is of rank 1 if and only if  $n-r$  is odd, we are done.

#### 4. SYMPLECTIC AND ORTHOGONAL SCHUR COMPLEXES

Let  $E$  be a free module over a  $\mathbb{Q}$ -algebra  $R$  and  $\varphi : E^* \rightarrow E$  an antisymmetric map. We will treat  $\varphi$  as a complex with the component  $E^*$  in degree  $-1$  and  $E$  in degree  $0$ . Let us consider the complex  $\varphi^{\otimes m}$  which is the  $m$ -th tensor power of  $\varphi$ . The symmetric group  $\Sigma_m$  acts on  $\varphi^{\otimes m}$  by permuting factors:

$$\sigma(x_1 \otimes \dots \otimes x_m) = (-1)^r x_{\sigma^{-1}(1)} \otimes \dots \otimes x_{\sigma^{-1}(m)}$$

where  $\sigma \in \Sigma_m$ ,  $x_i$  belongs to  $E$  or  $E^*$ , and  $r = \sum_{\substack{i < j \\ \sigma(i) > \sigma(j)}} \deg x_i \deg x_j$ .

It is easy to show that  $\sigma$  defined in this way is a map of complexes and that these operators give a left action of  $\Sigma_m$  on  $\varphi^{\otimes m}$ .

We now define another family of operators on  $\varphi^{\otimes m}$ . Let us consider the map of complexes

$$\text{tr} : R[1] \rightarrow \varphi \otimes \varphi ,$$

defined by  $\text{tr}(1) = \sum_i e_i \otimes e_i^* + \sum_i e_i^* \otimes e_i$  where  $\{e_i\}$  is a basis of  $E$  and  $\{e_i^*\}$  is the dual basis. We also have the dual map

$$\text{ev} : \varphi \otimes \varphi \rightarrow R[1]$$

defined by  $\text{ev}(x \otimes y^*) = y^*(x)$ ,  $\text{ev}(y^* \otimes x) = -y^*(x)$  for  $y^* \in E^*$ ,  $x \in E$ . We write in general  $\text{ev}(x \otimes y) = \langle x, y \rangle$ . We define now the basic operator

$$\tau : \varphi \otimes \varphi \rightarrow \varphi \otimes \varphi$$

as the composition  $\tau = \text{tr} \cdot \text{ev}$ .

For  $m$  bigger than 2 we define the operator  $\tau_{12}$

$$\tau_{12} : \varphi^{\otimes m} \rightarrow \varphi^{\otimes m}$$

as  $\tau \otimes \varphi^{\otimes m-2}$ . For arbitrary  $i, j$ ,  $1 \leq i \leq m$ ,  $1 \leq j \leq m$ ,  $i \neq j$ , we define  $\tau_{ij}$  as  $\sigma \tau_{12} \sigma^{-1}$  for  $\sigma \in \Sigma_m$  such that  $\sigma(1) = i$ ,  $\sigma(2) = j$ . One checks immediately that such a definition does not depend on the choice of  $\sigma$ . In this situation we have:

Proposition 4.1 The operators  $\sigma$ ,  $\tau_{ij}$  satisfy the following relations:

a)  $\tau_{ij}^2 = 0$  ,

- b)  $\tau_{ij} = -\tau_{ji}$  ,
- c)  $\sigma\tau_{ij} = \tau_{\sigma(i)\sigma(j)}\sigma$  ,
- d)  $(i, j)\tau_{ij} = \tau_{ij}$  where  $(i, j)$  stands for the transposition of  $i$  and  $j$  ,
- e)  $\tau_{ij}\tau_{ik} = (j, k)\tau_{ik} = \tau_{ij}(j, k)$  for different  $i, j, k$  ,
- f)  $\tau_{ij}\tau_{kl} = \tau_{kl}\tau_{ij}$  for different  $i, j, k, l$  ,
- g) 
$$\binom{i_1 \dots i_s j_1 \dots j_s}{i_{\alpha 1} \dots i_{\alpha s} j_{\alpha 1} \dots j_{\alpha s}} \tau_{i_1 j_1} \dots \tau_{i_s j_s} = \text{sign} \alpha \tau_{i_1 j_1} \dots \tau_{i_s j_s}$$
 for different  $i_1, \dots, i_s, j_1, \dots, j_s$ .

Proof We prove here only part a) of the proposition because this is the relation which does not hold in the case of the usual Brauer - Weyl algebras, and all the other identities can be proved by direct calculation. In order to prove  $\tau_{ij}^2 = 0$  it suffices to show it for  $\tau_{12}$ , so we can assume that we deal with  $\varphi^{\otimes 2}$  and we want to prove that the composition

$$\varphi^{\otimes 2} \xrightarrow{\tau} \varphi^{\otimes 2} \xrightarrow{\tau} \varphi^{\otimes 2}$$

is zero. Since  $\tau$  is zero in all degrees different than  $-1$ , it suffices to consider this composition on  $E \otimes E^*$ . For  $x \in E, y^* \in E^*$  we have:

$$\begin{aligned} \tau^2(x \otimes y^*) &= y^*(x)\tau\left[\sum_i e_i \otimes e_i^* + \sum_i e_i^* \otimes e_i\right] \\ &= y^*(x)\left[\sum_i e_i^*(e_i) - \sum_i e_i^*(e_i)\right]\text{tr}(1) = 0 \end{aligned}$$

Definition 4.2 We define the algebra  $A_m$  to be the algebra generated over  $R$  by the operators  $\sigma, \tau_{ij}$ .

**RESOLUTIONS OF DETERMINANTAL VARIETIES**

Now we compute  $A_m$  as an R-module.

Proposition 4.3  $A_m$  is a finite dimensional free R-module.

All the elements

$$(1) \quad \sigma \tau_{i_1 j_1} \tau_{i_2 j_2} \cdots \tau_{i_s j_s}$$

where  $i_1, \dots, i_s, j_1, \dots, j_s$  are different,  $i_k < j_k$  and  $\sigma(i_k) < \sigma(j_k)$  for arbitrary  $k$ ,  $i_1 < i_2 < \dots < i_s$ ,  $\sigma(i_1) < \sigma(i_2) < \dots < \sigma(i_s)$ , and  $s = 0, 1, \dots, [m/2]$ , form a basis of  $A_m$  over R.  $A_m$  is a quotient of a free R-algebra generated by the symbols corresponding to  $\sigma, \tau_{ij}$ , by the ideal determined by the relations a) - g).

Proof First we prove that the elements (1) generate  $A_m$  as an R-module. Using the relations a) - f) we see immediately that the elements of form (1) generate  $A_m$  as an R-module, where  $i_1, \dots, i_s, j_1, \dots, j_s$  are different,  $i_1 < \dots < i_s, i_k < j_k$  for all  $k$  and  $s = 0, 1, \dots, [m/2]$ . Now the relations c), d) and g) imply that for  $\sigma', \sigma'' \in \Sigma_m$   $\sigma' \tau_{i_1 j_1} \cdots \tau_{i_s j_s} = \pm \sigma'' \tau_{i_1 j_1} \cdots \tau_{i_s j_s}$  whenever  $\sigma'' = \sigma' \cdot \sigma$ , where  $\sigma$  belongs to the subgroup of  $\Sigma_m$  generated by the elements  $\begin{pmatrix} i_1 & \cdots & i_s & j_1 & \cdots & j_s \\ i_{\alpha 1} & \cdots & i_{\alpha s} & j_{\alpha 1} & \cdots & j_{\alpha s} \end{pmatrix}$  and the transpositions  $(i_k j_k)$ . This gives us the additional condition on  $\sigma$  in the formulation of the proposition.

Next we show that the elements (1) are linearly independent over R. We assume that  $\dim E \geq m$  and we are going to show that the elements (1) treated as endomorphisms of  $\varphi^{\otimes m}$  are R-independent.

We notice that an element  $\sigma \tau_{i_1 j_1} \cdots \tau_{i_s j_s}$  sends all



the components of  $\varphi^{\otimes m}$  of degree  $< s$  to 0. Hence it suffices to show that the elements (1) with fixed  $s$  act independently on  $\varphi_s^{\otimes}$ . Let us consider the following element in  $\varphi_s^{\otimes}$ :

$$x = f_1 \otimes \dots \otimes f_{i_1-1} \otimes e_{i_1}^* \otimes \dots \otimes e_{j_1} \otimes \dots \otimes e_{i_s}^* \otimes \dots \otimes e_{j_s} \otimes \dots \otimes f_m$$

where  $f_1, \dots, f_{i_1-1}, \dots, f_{i_s}, \dots, f_m, e_1, \dots, e_s$  are different basis elements in  $E$ . We see that an element  $\sigma_{\tau_{a_1 b_1} \dots \tau_{a_s b_s}}$  of form (1) sends  $x$  to 0 unless  $(a_k, b_k) = (i_k, j_k)$  for all  $k$ .

The action of  $\sigma_{\tau_{i_1 j_1} \dots \tau_{i_s j_s}}$  on  $x$  gives

$$\begin{aligned} \sigma_{\tau_{i_1 j_1} \dots \tau_{i_s j_s}}(x) &= \pm \sum_{\beta_1, \dots, \beta_s} f_{\sigma^{-1}(1)} \otimes \dots \\ &\dots \otimes \text{tr}_{\beta_k}^1 \otimes \dots \otimes \text{tr}_{\beta_k}^2 \otimes \dots \otimes f_{\sigma^{-1}(m)} \\ &\quad \sigma(i_k) \quad \sigma(j_k) \end{aligned}$$

where  $\sum_h \text{tr}_h^1 \otimes \text{tr}_h^2$  stands for the image of 1 under the map  $\text{tr}$  mentioned above. Therefore we see that the groups of elements corresponding to different  $i_1, \dots, j_s$  act in such a way that to prove their independence it is enough to show the independence of the elements  $\sigma_{\tau_{i_1 j_1} \dots \tau_{i_s j_s}}(x)$  of form (1) with fixed  $i_1, \dots, j_s$ .

In order to do this we can, without loss of generality, forget about factors involving  $f$ 's; i.e. we can assume that  $m = 2s$ , and we want to prove the independence of the elements  $\sigma_{\tau_{i_1 j_1} \dots \tau_{i_s j_s}}(x)$  of form (1) for  $x = \dots \otimes e_{i_k}^* \otimes \dots \otimes e_{j_k} \otimes \dots$ , with  $s, i_k, j_k$ , being fixed.

Let  $a_\sigma$  be  $\sigma_{\tau_{i_1 j_1} \dots \tau_{i_s j_s}}(x)$  for  $\sigma$  satisfying condition (1). Let us consider a vector  $\dots \otimes e_{a_k}^* \otimes \dots \otimes e_{b_k} \otimes \dots$  in

$\varphi^{\otimes 2s}$  for a fixed set  $a_1, \dots, a_s$  of distinct numbers from  $[1, 2s]$  such that  $a_1 < a_2 \dots < a_s$ ,  $a_k < b_k$  for all  $k$ . Look at the coefficient of  $a_\sigma$  with respect to this basis element. We know that in each summand of  $a_\sigma$  we have the same number of the basis vectors in the places  $i_k$  and  $j_k$  and that over exactly one of them there is a star. So it is clear, recalling condition (1) for  $\sigma$ , that our coefficient equals 0 unless  $i_k = a_k$  and  $j_k = b_k$  for all  $k$ , and that in this case our coefficient equals  $\pm 1$ . Hence the independence of the elements (1) is proved.

Remark 4.4 We can push the permutations to the right of the  $\tau$ 's to obtain a basis consisting of the elements

$$(2) \quad \tau_{i_1 j_1} \dots \tau_{i_s j_s}^\sigma$$

for distinct  $i_1, \dots, j_s$ ,  $i_1 < \dots < i_s$ ,  $\sigma^{-1}(i_1) < \dots < \sigma^{-1}(i_s)$  and  $i_k < j_k$ ,  $\sigma^{-1}(i_k) < \sigma^{-1}(j_k)$  for all  $k$ .

Remark 4.5 The algebra  $A_m$  is very similar to the Brauer - Weyl algebra defined in [De Concini - Procesi]. The only difference is that the relation a) here is replaced by  $\tau_{ij}^2 = n\tau_{ij}$ ,  $n$  being the dimension of the module in question. This difference turns out to be significant because our algebra is not semisimple.

Definition 4.6 We define an ideal  $J_s$  in  $A_m$ ,  $s > 0$ , to be the two-sided ideal generated by all elements  $\tau_{i_1 j_1} \dots \tau_{i_s j_s}$  for distinct indices  $i_1, \dots, j_s$ . Moreover we put  $J_0 = A_m$ .

Definition 4.7 Let

$$W_d \varphi = J_d \varphi^{\otimes m} / J_{d+1} \varphi^{\otimes m} \quad \text{for } d \geq 0 .$$

An  $R[\Sigma_m]$ -module structure on  $W_0\varphi$  comes from the embedding  $R[\Sigma_m] \hookrightarrow A_m$ . We define the symplectic Schur complex  $A_I\varphi$  to be

$$\text{Hom}_{\Sigma_m}(S_I, W_0\varphi)$$

where  $S_I$  denotes here the Specht module corresponding to  $I$  (see e.g. [Nielsen] for a definition of the Specht module).

It follows directly from the definition that  $W_0\varphi$  decomposes as an  $R[\Sigma_m]$ -module:

$$W_0\varphi = \sum_{|I|=m} S_I \otimes A_I\varphi$$

Remark 4.8  $A_I\varphi$  can be treated in a convenient way as a co-kernel. We have an exact sequence of  $\Sigma_m$ -modules

$$\sum_{(i,j)} \varphi^{\otimes(m-2)}_{(i,j)} \rightarrow \varphi^{\otimes m} \rightarrow W_0\varphi \rightarrow 0$$

where the module on the left is the module induced from  $\Sigma_2 \times \Sigma_{m-2}$ -module  $S_2 \otimes \varphi^{\otimes(m-2)}$  over  $\Sigma_m$ . Applying  $\text{Hom}_{\Sigma_m}(S_I, -)$  to this sequence we get the exact sequence

$$S_{I/2}\varphi[1] \xrightarrow{\eta_I} S_I\varphi \rightarrow A_I\varphi \rightarrow 0 .$$

The formula (2.10) is also valid for Schur complexes, [Nielsen], hence  $S_{I/2}\varphi = \sum_J S_J\varphi$  where we sum over all  $J$  contained in  $I$  such that  $I/J$  has two squares and  $I/J$  has at most one square in each column. The map  $\eta_I|_{S_J}$  is the composition  $S_J\varphi[1] \xrightarrow{1 \otimes \text{tr}} S_J\varphi \otimes S_2\varphi \rightarrow S_I\varphi$ , where the second map comes from the Pieri formula (2.9) which is also valid for Schur complexes.

Examples 4.9

a) If  $I = (1^m)$  then the corresponding  $J$ 's do not exist and we get  $A_{(1^m)} \varphi = \Lambda^m \varphi$ .

b) If  $I = (m)$  then there is just one corresponding  $J = m-2$  and we have the exact sequence

$$S_{m-2} \varphi[1] \rightarrow S_m \varphi \rightarrow A_m \varphi \rightarrow 0 .$$

Its  $i$ -th component,  $i \geq 0$ , looks like

$$\Lambda^{i-1} E^* \otimes S_{m-i-1} E \xrightarrow{\eta_{i-1}} \Lambda^i E^* \otimes S_{m-i} E \rightarrow (A_m \varphi)_i \rightarrow 0$$

The map  $\eta_{i-1}$  is given by the trace. By duality  $\Lambda^j E = \Lambda^{n-j} E^*$  so we conclude using the Pieri formula that

$$(A_m \varphi)_i = S_{(m+1-i, 1^{m-i-1})} E$$

c) If  $I = (2,2)$  then we get the exact sequence

$$S_2 \varphi[1] \rightarrow S_{2,2} \varphi \rightarrow A_{2,2} \varphi \rightarrow 0$$

The components of this sequence look like

$$\begin{array}{ccc} & & S_{2,2} E^* \\ & & \downarrow \\ \Lambda^2 E^* & \rightarrow & S_{2,1} E^* \otimes E \\ & & \downarrow \\ & & S_2 E^* \otimes \Lambda^2 E \\ & & \otimes \\ E^* \otimes E & \rightarrow & \Lambda^2 E^* \otimes S_2 E \\ & & \downarrow \\ S_2 E & \rightarrow & E^* \otimes S_{2,1} E \\ & & \downarrow \\ & & S_{2,2} E \end{array}$$

and the horizontal maps come from the trace map. If  $\dim E = n$ ,

then in terms of  $E$  the components of  $A_{2,2}\varphi$  are:

$$S_{2,2}^E, S_{2,2,1}^{n-2E} + S_{3,2,1}^{n-3E}, S_{3,2}^{n-2,1}E + S_{3^2,2}^{n-3E} + \\ + S_{3,1}^{n-3E}, S_{2}^{n-1}E + S_{3,2}^{n-3,1}E, S_{2}^{n-2}E.$$

One could make the degrees of the representations the same in each component by multiplying each representation by a suitable power of the determinant. Then the map in the complex  $A_{2,2}\varphi$  would have degree 2 with respect to  $E$ . Observe that the kernel of the map  $S_2\varphi[1] \rightarrow S_{2,2}\varphi$  is just a copy of  $R$  so we get an exact sequence:

$$0 \rightarrow R[2] \rightarrow S_2\varphi[1] \rightarrow S_{2,2}\varphi \rightarrow A_{2,2}\varphi \rightarrow 0$$

Definition 4.10 We define the dual complexes  $B_I\varphi = S_I\varphi \cap \bigcap_{i,j} \text{Ker } \tau_{ij}$ .

It is obvious that  $(B_I\varphi)^* = A_{\tilde{I}}\varphi$  because we have  $(S_I\varphi)^* = S_{\tilde{I}}\varphi$ .

Now we intend to show how the Schur complexes can be filtered in such a way that the associated graded object consists of the  $A_I$ 's ( $B_I$ 's). Unfortunately this can be done only under the additional assumption that  $n = \dim E \geq m = |I|$ .

We define a complex of complexes:

$$K_*(m): \dots \xrightarrow{\delta} \sum_{\substack{(i_1 j_1) \\ \dots \\ (i_s j_s)}} \varphi^{\otimes(m-2s)} \dots \xrightarrow{\delta} \sum_{(i j)} \varphi^{\otimes(m-2)} \rightarrow \varphi^{\otimes m}$$

where we label  $\varphi^{\otimes(m-2s)}$  by the indices  $(i_1 j_1) \dots (i_s j_s)$  with all numbers different, satisfying  $i_1 < i_2 < \dots < i_s$  and  $i_k < j_k$  for all  $k$ . A map  $\delta$  on the corresponding summand is

equal to

$$\text{tr}_{i_t j_t} : \varphi^{\otimes(m-2s)}_{(i_1 j_1) \dots (i_s j_s)} \rightarrow \varphi^{\otimes(m-2s+2)}_{(i_1 j_1) \dots (\widehat{i_t j_t}) \dots (i_s j_s)}$$

which is defined to be the trace on the indicated copies of  $\varphi$ . On the other summands the map  $\delta$  is defined to be zero. It is easy to check that  $\text{tr}_{i_t j_t} \cdot \text{tr}_{i_u j_u} = -\text{tr}_{i_u j_u} \cdot \text{tr}_{i_t j_t}$  so that we have really a complex.

Lemma 4.11 The complex  $K_*(m)$  is acyclic with  $H_0(K_*(m)) = W_0 \varphi$  provided  $\dim E = n \geq m$ .

Proof We will show that the complex  $K_*(m)$  is acyclic even over the ring  $\mathbb{Z}_{(2)}$  the localisation of  $\mathbb{Z}$  with respect to the ideal  $(2)$ . We proceed by induction on  $m$ . We have an exact sequence of complexes

$$(3) \quad 0 \rightarrow \varphi \otimes K_*(m-1) \xrightarrow{\alpha} K_*(m) \xrightarrow{\beta} \sum_{j=2}^m K_*^{-1}(m-2) \rightarrow 0$$

where  $\alpha$  is an injection onto all  $\varphi^{\otimes(m-2s)}_{(i_1 j_1) \dots (i_s j_s)}$  such that  $1 \notin \{i_1, \dots, i_s\}$ . The  $j$ -th copy of  $K_*^{-1}(m-2)$  corresponds to all  $\varphi^{\otimes(m-2s-2)}_{(1 j)(i_1 j_1) \dots (i_s j_s)}$  and  $\beta$  is just the projection. From the long homology sequence we obtain

$$0 \rightarrow H_1(K_*(m)) \rightarrow \sum_{j=2}^m W_0(m-2) \xrightarrow{\gamma} \varphi \otimes W_0(m-1) \rightarrow W_0(m) \rightarrow 0$$

where  $W_0(j)$  stands for  $W_0 \varphi$  determined by  $\varphi^{\otimes j}$ . It suffices to show that the map  $\gamma$  is injective. However we can dualize the complexes, and taking the cohomology groups we obtain the sequence

$$0 \rightarrow V_0(m) \rightarrow \varphi \otimes V_0(m-1) \rightarrow \sum_{j=2}^m V_0(m-2)$$

where

$$V_0(m) = \bigcap_{i,j} \text{Ker } \tau_{ij} .$$

We must show that the last map is surjective. The map from  $\varphi \otimes V_0(m-1)$  to  $\sum_{j=2}^m V_0(m-2)$  is in fact given by  $\sum_{j=2}^m \tau_{1j}$ . To prove the surjectivity of this map it is enough to do it over  $\mathbb{Z}_{(2)}/2\mathbb{Z}_{(2)} = \mathbb{Z}/2\mathbb{Z}$ .  $V_0(m-1)$ ,  $V_0(m-2)$  commute with this change of rings because they are free  $\mathbb{Z}_{(2)}$ -modules by induction hypothesis. However in characteristic 2 a permutation  $\sigma$  acts on  $\varphi^{\otimes m}$  just by  $\sigma(x_1 \otimes \dots \otimes x_m) = x_{\sigma^{-1}(1)} \otimes \dots \otimes x_{\sigma^{-1}(m)}$ ; hence it acts as a usual permutation on the module  $F = E \otimes E^*$  with the antisymmetric form  $\langle , \rangle$  described above. Therefore we can use the characteristic - free results from [De Concini - Strickland]. Step 1 of their proof of Theorem 2.1 (p. 122), which is independent of the theory of symplectic standard tableaux, shows the surjectivity of our map. At this point we use that  $n \geq m$ .

Corollary 4.12 For  $m \leq n = \dim E$  we have

$$W_d \varphi = \sum_{(i_1 j_1), \dots, (i_d j_d)} \tau_{i_1 j_1} \dots \tau_{i_d j_d} \varphi^{\otimes(m-2d)} / J_1 \varphi^{\otimes(m-2d)}$$

Proof The only thing to prove is that the sum is direct. Using the sequence (3) we compare the dimensions of  $\varphi^{\otimes m}$  and the sum of the dimensions of  $W_d$  obtained from the right side of the formula. The desired equality is

$$\begin{aligned} (2n)^m &= \sum_{i=0}^{\infty} \frac{m!}{(m-2i)! 2^i i!} \dim W_0(m-2i) = \\ &= \sum_{i=0}^{\infty} \sum_{j=0}^{\infty} \frac{m!}{(m-2i)! 2^i i!} (-1)^j (2n)^{m-2i-2j} \frac{(m-2i)!}{(m-2i-2j)! 2^j j!} \end{aligned}$$

We treat both sides as the polynomials in  $2n$ . To compute the coefficient of  $(2n)^{m-2s}$  on the right we note that for  $s = 0$  it is 1 and for  $s > 0$  it is

$$\begin{aligned} & \sum_{i+j=s} (-1)^j \frac{m!}{(m-2i)!2^i i!} \frac{(m-2i)!}{(m-2i-2j)!2^j j!} = \\ & = \frac{m!}{(m-2s)!2^s s!} \sum_{i+j=s} (-1)^j \frac{s!}{i!j!} . \end{aligned}$$

Since

$$\sum_{i+j=s} \frac{(-1)^j s!}{i!j!} = \sum_j (-1)^j \binom{s}{j} = 0$$

our coefficient is zero and the corollary is proved.

Now we want to analyse the structure of  $W_d$  as an  $\Sigma_m$ -module. For this purpose we introduce the following definition.

Definition 4.13 Let  $I$  be a partition of  $m-2s$ . We define the  $A_m$ -module  $A_I$  to be equal to

$$A_m \tau_{p_1 q_1} \dots \tau_{p_s q_s} e(I) / J_{s+1} e(I) \cap A_m \tau_{p_1 q_1} \dots \tau_{p_s q_s} e(I)$$

where  $e(I)$  is the Young idempotent in  $R[\Sigma_{m-2s}]$  associated to  $I$  and  $\Sigma_{m-2s}$  acts on the numbers complementary to  $p_1, \dots, q_s$ .

From Corollary 4.12 it follows immediately

Proposition 4.14 If  $R$  is  $\mathbb{Q}$ -algebra and  $m \leq n = \dim E$  then

$$W_d \varphi = \sum_{|J|=m-2d} A_J \circ A_J \varphi$$

as a complex of  $A_m$ -modules.

We want to compute the decomposition (up to filtration) of the complexes  $S_I \varphi$  into  $A_J \varphi$ . To do this we need



Proposition 4.15 Let  $J$  be a partition of  $m-2s$ . Treating  $A_J$  as an  $\Sigma_m$ -module via the canonical embedding  $R[\Sigma_m] \hookrightarrow A_m$  we have the following decomposition of  $\Sigma_m$ -modules:

$$A_J = \sum_I (I, J; L) S_L$$

where  $(I, J; L)$  is the coefficient occurring in the Littlewood - Richardson rule (2.8) and the sum ranges over all partitions  $I$  of weight  $2s$  of the form  $(a_1+1, \dots, a_r+1 | a_1, \dots, a_r)$  (compare (2.6)).

Proof Let us look at the  $\Sigma_m$ -module  $A_J$ . It is induced from the representation  $P \otimes S_J$  of the subgroup  $\Sigma_{2s} \times \Sigma_{m-2s}$  ( $2s$  places correspond to the  $\tau$ 's, the others to the partition  $J$ ). Here  $P$  is a representation with generators  $\{\tau_{i_1 j_1} \dots \tau_{i_s j_s} \mid \{i_1, \dots, j_s\} = \{1, \dots, 2s\}\}$  satisfying the relations  $(i, j)\tau_{ij} = \tau_{ij}$ ,  $(i, k)(j, l)\tau_{ij}\tau_{kl} = -\tau_{ij}\tau_{kl}$  and  $\tau_{ij}\tau_{kl} = \tau_{kl}\tau_{ij}$ . One could construct  $P$  by taking a  $2s$ -dimensional free  $R$ -module  $F$ , and considering the elements in  $\Lambda^s(S_2 F)$  of weight  $(1, 1, \dots, 1)$  with respect to the maximal torus in  $GL(F)$  with the obvious action of  $\Sigma_{2s}$  on it. The plethysm formulas (2.6) show that  $P = \sum_I S_I$  where  $I$  ranges over all partitions of weight  $2s$  of the form  $(a_1+1, \dots, a_r+1 | a_1, \dots, a_r)$ . Now the proposition follows from the Littlewood - Richardson rule.

We know (compare [Nielsen]) that

$$\varphi^{\otimes m} = \sum_{|I|=m} S_I \otimes S_I \varphi \text{ as a } \Sigma_m\text{-module.}$$

Let us define the complexes  $S_I^d \varphi$  by the formula

$$W_d \varphi = \sum_{|I|=m} S_I \otimes S_I^d \varphi$$

It is clear that there is a filtration on  $S_I\varphi$  with the associated graded object equal to  $\sum_{d \geq 0} S_I^d\varphi$ . In this situation we get

Theorem 4.16 For  $m \leq n = \dim E$

$$S_L^d\varphi = \sum_{|J|=m-2d} \sum_I (I, J; L) A_J\varphi$$

where the inner summation runs over all  $I = (a_1+1, \dots, a_r+1 | a_1, \dots, a_r)$  of weight  $2d$ .

Proof The conclusion of the theorem follows directly from Propositions 4.14 and 4.15.

The main application of the theorem just proved is the following

Theorem 4.17 Let  $\varphi : E^* \rightarrow E$ ,  $\psi : F^* \rightarrow F$  be two anti-symmetric maps,  $I$  a partition of  $m$  and  $m \leq n = \dim E$ . Then

$$A_I(\varphi + \psi) = \sum_{J \subset I} A_J\varphi \otimes S_{I/J}\psi$$

up to filtration.

Proof By Remark 4.8 and the linearity formula for skew partitions we have the following diagram

$$\begin{array}{c} S_{I/2}(\varphi + \psi)[1] \rightarrow S_I(\varphi + \psi) \rightarrow A_I(\varphi + \psi) \rightarrow 0 \\ \parallel \\ \sum_J S_{J/2} \otimes S_{I/J}\psi[1] \rightarrow \sum_J S_J\varphi \otimes S_{I/J}\psi \end{array}$$

Moreover, the map  $\text{tr } \varphi$  acts from  $S_{J/2}\varphi \otimes S_{I/J}\psi$  to  $S_J\varphi \otimes S_{I/J}\psi$  and the map  $\text{tr } \psi$  increases the number of squares in the partitions belonging to  $\psi$  by two.

Let us order the partitions  $J \subset I$  by saying that  $J_1 < J_2$  if and only if  $|J_1| > |J_2|$  or  $|J_1| = |J_2|$  and  $J_1$  is earlier than  $J_2$  lexicographically. Let us define the filtration  $\{F_J\}$  on  $A_I(\varphi + \psi)$  by letting  $F_J$  be the image of  $\sum_{L \leq J} S_L \varphi \otimes S_{I/L} \psi$ . We claim that  $F_J / \sum_{L < J} F_L$  is a factor of  $A_J \varphi \otimes S_{I/J} \psi$ . Indeed, let us consider the relation coming from  $S_{J/2} \varphi \otimes S_{I/J} \psi$ . It goes by  $\text{tr } \varphi$  to  $S_J \varphi \otimes S_{I/J} \psi$  and by  $\text{tr } \psi$  to the earlier piece of filtration. Therefore Remark 4.8 shows our claim.

To prove the equality it suffices now to compare the dimensions on both sides of the formula. Observe that the following equalities hold up to filtration

$$\sum_J S_J \varphi \otimes S_{I/J} \psi = S_I(\varphi + \psi) = \sum_{J, L} (L, J; I) A_I(\varphi + \psi)$$

where the second sum ranges over all  $L = (a_1+1, \dots, a_r+1 | a_1, \dots, a_r)$  of weight  $2d$ . By induction we know the decompositions of  $A_J(\varphi + \psi)$  for  $J \not\subset I$ . Using them we obtain the desired equality of dimensions.

A serious restriction of the theorems just proved is the assumption  $m \leq n$ . Without this assumption the theorems are not true (see the example below) but there should exist a decomposition which differs from the given one only by a few exceptional terms. The key step in the proof is the understanding of the homology of  $K_*(m)$  in the general case.

Example 4.18 The decompositions mentioned above show that  $S_m \varphi = A_m \varphi + A_{m-2} \varphi$  up to filtration. If they were true in general the following sequence would have to be exact

$$\dots \rightarrow S_{r-2} \varphi \xrightarrow{\text{tr}} S_r \varphi \xrightarrow{\text{tr}} S_{r+2} \varphi \rightarrow \dots$$

*RESOLUTIONS OF DETERMINANTAL VARIETIES*

If  $n = \dim E$  the  $n$ -th component of this complex looks like

$$0 \rightarrow \Lambda^n E^* \rightarrow \Lambda^{n+1} E^* \otimes E \rightarrow \dots$$

Since  $\Lambda^{n+1} E^* = 0$  we get the homology  $\Lambda^n E^*$ . It is easy to show that in this case it is the only homology of the whole complex, so there is only one deviation from the decomposition established above.

We continue now with some remarks on the category of  $A_m$ -modules. Recall, (4.13), that we defined the family of  $A_m$ -modules  $A_I$  for  $|I| = m-2s$ .

The modules  $A_I$  are not irreducible. We will show however that the irreducibles are in 1-1 correspondence with the partitions  $I$  of  $m-2s$ ,  $s = 0, 1, \dots, \lfloor m/2 \rfloor$ .

Proposition 4.19 Let us assume that  $R$  is a field and  $C_I = \{x \in A_I \mid J_S x = 0\}$ . Then the modules  $A_I/C_I$ ,  $|I| = m-2s$ ,  $s = 0, 1, \dots, \lfloor m/2 \rfloor$ , form a complete set of irreducible  $A_m$ -modules.

Proof First we show that  $A_I/C_I$  are irreducible. Let  $0 \neq x \in A_I/C_I$ ; we will prove that  $x$  generates  $A_I/C_I$ . We have  $J_S x \neq 0$  because otherwise we get  $J_S^2 x = 0$  in  $A_I$  and since  $J_S^2 = J_S$  we would have  $x \in C_I$ , which is a contradiction. We infer that there exist  $\tau_{i_1 j_1}, \dots, \tau_{i_s j_s}$  such that  $y = \tau_{i_1 j_1} \dots \tau_{i_s j_s} x$  determines a non-zero element in  $A_I/C_I$ . By Proposition 4.1 d) and e) we see that  $y$  is an element of the form  $\tau_{i_1 j_1} \dots \tau_{i_s j_s} z$  with  $z \in R[\Sigma_m]$ . It is easy to see that the vectors of this form in  $A_I$  form in fact the Specht module  $S_I$  over  $R[\Sigma_{m-2s}]$  the other permutations acting on the left change the indices  $i_1, \dots, j_s$ . Now acting

on the left by  $\Sigma_{m-2s}$  we can generate all of  $S_I$ . This proves that the element  $\tau_{i_1} \dots \tau_{i_s} j_s e(I)$  belongs to the submodule generated by  $y$  (and hence  $x$ ) showing that  $x$  generates all of  $A_I/C_I$ .

To prove that  $A_I/C_I$  form a complete set of the irreducible  $A_m$ -modules we have to show that  $A_m$  has a composition series with factors  $A_I/C_I$ . We show by induction that  $J_s/J_{s+1}$  has such a series. For  $s = 0$  we get simply the known result for the symmetric group. Let us assume that we have the result for the numbers smaller than  $s$ . We know that  $J_s/J_{s+1} = \sum_{|I|=m-2s} t_I A_I$  where  $t_I$  is the multiplicity of  $S_I$  in the composition series of  $R[\Sigma_{m-2s}]$ . Now it suffices to decompose  $C_I$  in terms of  $A_J/C_J$ . But we know that  $C_I$ 's are in fact  $A_m/J_s$ -modules, so we get our claim by the induction hypothesis.

The last thing to prove is that all the  $A_I/C_I$  are different. We note that if  $|I| = m-2s$ ,  $J_s(A_I/C_I) = A_I/C_I$  and  $J_{s+1}(A_I/C_I) = 0$  so we can distinguish all the levels  $s$ . For a fixed  $s$  we see that the modules  $A_I/C_I$  are not isomorphic when restricted to  $\Sigma_{m-2s}$ . This completes the proof of the proposition.

Now we proceed to outline the analogous theory for the symmetric map  $\varphi : E^* \rightarrow E$ . The symmetry of  $\varphi$  allows us to define two maps:

$$\text{tr}' : R[1] \rightarrow \Lambda^2 \varphi \rightarrow \varphi \otimes \varphi$$

defined by

$$\text{tr}'(1) = \sum_i e_i \otimes e_i^* - \sum_L e_i^* \otimes e_i$$

and the dual map

$$\text{ev}' : S_2\varphi \rightarrow R[1].$$

Now we can consider the operator  $\tau : \varphi \otimes \varphi \xrightarrow{\text{ev}' } R \xrightarrow{\text{tr}' } \varphi \otimes \varphi$  and we define the algebra  $A'_m$  to be generated by the permutations  $\sigma \in \Sigma_m$  and the traces  $\tau_{ij}$  acting on  $\varphi^{\otimes m}$ . The analogue of 4.1 and 4.3 is

Proposition 4.20 The algebra  $A'_m$  is a quotient of a free R-algebra generated by the symbols corresponding to  $\sigma, \tau_{ij}$ , by the ideal determined by the following relations:

$$a') \quad \tau_{ij}^2 = 0 ,$$

$$b') \quad \tau_{ij} = -\tau_{ji} ,$$

$$c') \quad \sigma \tau_{ij} = \tau_{\sigma(i)\sigma(j)} \sigma ,$$

$$d') \quad (i,j)\tau_{ij} = -\tau_{ij} ,$$

$$e') \quad \tau_{ij}\tau_{ik} = \tau_{ij}(j,k) = (j,k)\tau_{ik} \quad \text{for different } i,j,k ,$$

$$f') \quad \tau_{ij}\tau_{kl} = \tau_{kl}\tau_{ij} \quad \text{for different } i,j,k,l ,$$

$$g') \quad \begin{pmatrix} i_1, \dots, i_s, j_1, \dots, j_s \\ i_{\alpha 1}, \dots, i_{\alpha s}, j_{\alpha 1}, \dots, j_{\alpha s} \end{pmatrix} \tau_{i_1 j_1} \dots \tau_{i_s j_s} = \text{sign } \alpha \tau_{i_1 j_1} \dots \tau_{i_s j_s}$$

$A'_m$  is a free R-module of finite rank. All the elements

$$\sigma \tau_{i_1 j_1} \dots \tau_{i_s j_s}$$

where  $i_1, \dots, i_s, j_1, \dots, j_s$  are different,  $i_k < j_k$  and  $\sigma(i_k) < \sigma(j_k)$  for all  $k, i_1 < \dots < i_s, \sigma(i_1) < \dots < \sigma(i_s)$ , and  $s = 0, 1, \dots, [m/2]$ , form a basis of  $A'_m$  over R.

The only difference with 4.1 is the relation d').

One can define the ideals  $J'_s$  in  $A'_m$  as the two-sided ideals generated by all elements  $\tau_{i_1 j_1} \cdots \tau_{i_s j_s}$  ( $i_1, \dots, j_s$  different). Now we define the complexes

$$A'_I \varphi = \text{Hom}_{\Sigma_m} (S_I, W'_0 \varphi)$$

where

$$W'_0 \varphi = \varphi^{\otimes m} / J'_1 \varphi^{\otimes m}.$$

We also define the dual complexes  $(B'_I \varphi)^* = A'_{I \sim} \varphi$ . Here are the main results on these complexes.

$A'_I \varphi$  can be treated as a cokernel

$$S_{I/(1^2)} \varphi[1] \rightarrow S_I \varphi \rightarrow A'_I \varphi \rightarrow 0$$

One gets the analogues of Theorems 4.16 and 4.17. Let  $W'_d \varphi = J'_d \varphi^{\otimes m} / J'_{d+1} \varphi^{\otimes m}$ . Let us decompose  $W'_d \varphi$  as a  $\Sigma_m$ -module:

$$W'_d \varphi = \sum_{|I|=m} S_I \otimes S_I^d \varphi$$

Theorem 4.21 For  $\dim E = n \geq m$  we have

$$S_K^d \varphi = \sum_{|J|=m-2d} \sum_I (I, J; K) A'_J \varphi$$

where the sum ranges over all  $I = (a_1, \dots, a_r | a_1+1, \dots, a_r+1)$  of weight  $2d$ .

Theorem 4.22 Let  $\varphi : E^* \rightarrow E$ ,  $\psi : F^* \rightarrow F$  be two symmetric maps,  $I$  a partition of  $m$  and  $m \leq n = \dim E$ . Then

$$A'_I(\varphi + \psi) = \sum_{J \subset I} A'_J \varphi \otimes S_{I/J} \psi$$

up to filtration.

The only difference between 4.21 and 4.16 is that in 4.21 we sum over all  $(a_1, \dots, a_r | a_1+1, \dots, a_r+1)$  while in

4.16 we summed over all  $(a_1+1, \dots, a_r+1 | a_1, \dots, a_r)$ .

This is a consequence of the different relation  $d'$  which changes the module  $P$  mentioned in the proof of 4.15.

5. EXPLICIT DESCRIPTION OF MINIMAL FREE RESOLUTIONS  
IN LOW CODIMENSION

In this section we give an explicit construction of minimal free resolutions of determinantal ideals of low codimension associated with antisymmetric and symmetric matrices. We present a uniform approach to this problem, reproving in a simple way already known cases. This method suggests a general construction (for all determinantal ideals). However technical difficulties have been until now the main obstacle to giving precise proofs.

In this approach one uses both  $E$  and  $E^*$  to describe components and this makes it easier to define differentials. Of course, these components are isomorphic to the ones described in section 3.

Our main tools in proving the exactness of the complexes in question are two lemmas. We keep notation introduced in the previous sections with one exception. We write  $R$  instead of  $\mathcal{O}_X$  to denote  $S_*(\Lambda^2 U)$  or  $S_*(S_2 U)$  where  $U$  is a vector space over  $K$  of dimension  $n$ . In particular  $E = U \otimes_K R$  and  $\varphi : E^* \rightarrow E$  is a generic antisymmetric (symmetric) map. The field  $K$  is always assumed to be of characteristic zero.



Lemma 5.1 Consider  $X = \Lambda^2 U^*$  as a representation of  $G = GL(U^*)$ . Let  $R = S_*(\Lambda^2 U)$  be the coordinate ring of  $X$  and  $F_\bullet : \dots \rightarrow F_2 \rightarrow F_1 \rightarrow F_0$  a free  $G$ -complex over  $R$  with  $H_0(F_\bullet) = R/Pf_{2p+2}(\varphi)$ . If the length of  $F_\bullet$  is  $(n-2p-1)(n-2p)/2$  then  $F_\bullet$  is acyclic if and only if  $F_{\bullet, w} = F_\bullet \otimes R_w$  is acyclic for  $w = w_1 \wedge w_2 + \dots + w_{2p+1} \wedge w_{2p+2} \in X$  (where  $w_1, \dots, w_n$  is a basis of  $U^*$ ).

Proof One can assume that  $K$  is algebraically closed, i.e. the set of maximal ideals  $\text{Max}(X)$  of  $R$  is in 1-1 correspondence with the closed points of  $X$ . It suffices to prove that  $Z = \text{Max}(X) \cap \text{Supp } F_\bullet$  is empty. Observe that  $\text{Supp } F_\bullet$  is  $G$ -invariant and closed, and  $X$  is a finite union of orbits so that  $Z$  (if non-empty) must be a closure of an orbit. Indeed, if closed points of  $X$  are considered as antisymmetric  $n \times n$  matrices all orbits are determined by a rank condition and the closure of an orbit of matrices of rank  $r$  consists of all matrices of rank  $\leq r$ . Suppose that  $Z$  is non-empty. It follows from the acyclicity lemma [Peskin-Szpiro] that there exists a prime  $P \in \text{Supp } F_\bullet$  such that  $\text{depth } P < \text{length } F_\bullet$ . Since  $\text{length } F_\bullet = (n-2p-1)(n-2p)/2 = \text{depth } Pf_{2p+2}(\varphi)$  by hypothesis and by [Józefiak-Pragacz], we infer that there exists  $z \in Z$  corresponding to a matrix of rank  $\geq 2p+2$ . However in the closure of the orbit of that matrix there lies a matrix corresponding to  $w = w_1 \wedge w_2 + \dots + w_{2p+1} \wedge w_{2p+2}$  and  $w \notin Z$  by hypothesis, so that we get the required contradiction.

Using similar arguments we also obtain

Lemma 5.2 Consider  $X = S_2U^*$  as a representation of  $G = GL(U^*)$ . Let  $R = S_*(S_2U)$  be the coordinate ring of  $X$  and  $F_* : \dots \rightarrow F_2 \rightarrow F_1 \rightarrow F_0$  a free  $G$ -complex over  $R$  with  $H_0(F_*) = R/I_{r+1}(\varphi)$ . If the length of  $F_*$  is  $(n-r)(n-r+1)/2$  then  $F_*$  is acyclic if and only if  $F_{*w}$  is acyclic for  $w = w_1^2 + \dots + w_{r+1}^2 \in X$  ( $w_1, \dots, w_n$  being a basis of  $U^*$ ).

First we treat the case of an antisymmetric map  $\varphi : E^* \rightarrow E$  determined by a generic antisymmetric matrix  $T = (T_{ij})$ . It will be convenient to write  $Pf(i, j, k, \dots)$  for the pfaffian of the matrix obtained from  $T$  by omitting rows and columns with indices  $i, j, k, \dots$ . If  $e_1, \dots, e_n$  is a basis of  $E$  and we denote by  $e(i, j, k, \dots)$  the element  $e_i \wedge e_j \wedge e_k \wedge \dots$  in the exterior algebra of  $E$  then the equality

$$\begin{aligned} e(i, j, k, \dots) \wedge e(1, 2, \dots, \hat{i}, \dots, \hat{j}, \dots, \hat{k}, \dots, n) &= \\ &= v(i, j, k, \dots) e_1 \wedge \dots \wedge e_n \end{aligned}$$

defines  $v(i, j, k, \dots)$  which takes values  $\pm 1$ . Observe that  $v$  is an alternating function of its arguments so that  $Pf'(i, j, k, \dots) = v(i, j, k, \dots) Pf(i, j, k, \dots)$  defines a map from a suitable exterior power of  $E$  into  $R$ . These functions appear frequently in considerations with pfaffians. We quote for example the following Laplace type expansion for future reference

$$(1) \quad \sum_j Pf'(i, j) T_{sj} = \begin{cases} 0 & \text{for } s \neq i \\ Pf(T) & \text{for } s = i. \end{cases}$$

where  $T = (T_{ij})$  is an alternating matrix of even order.

Theorem 5.3 [Buchsbaum-Eisenbud] If  $2p+2 = n-1$  then

$$(2) \quad R \xrightarrow{\alpha^*} E^* \xrightarrow{\varphi} E \xrightarrow{\alpha} R$$

is a minimal free resolution of  $R/Pf_{2p+2}(\varphi)$  where  $\alpha(e_i) = Pf'(i)$ .

Proof From (1) it follows that  $\sum_j Pf'(j) T_{sj} = 0$  so that (2) is a complex. To check the exactness we use Lemma 5.1.

For 
$$\varphi = (0) \oplus \begin{pmatrix} 0 & 1 \\ -1 & 0 \end{pmatrix} \oplus \dots \oplus \begin{pmatrix} 0 & 1 \\ -1 & 0 \end{pmatrix}$$

$\text{Ker } \alpha = \{e_2, \dots, e_n\} = \text{Im } \varphi$  ; by duality  $\text{Im } \alpha^* = \text{Ker } \varphi$  .

Now suppose that  $2p+2 = n-2$  . We are going to construct a double complex with 4 rows  $W^{(0)}$ ,  $W^{(1)}$ ,  $W^{(2)}$ ,  $W^{(3)}$

$$(3) \quad \begin{array}{ccccccc} & & & & & & W_3^{(3)} \\ & & & & & & \downarrow \\ & & & & & & W_3^{(2)} \rightarrow W_2^{(2)} \rightarrow W_1^{(2)} \\ & & & & & & \quad \quad \quad \downarrow d_1 \\ & & & & & & W_2^{(1)} \rightarrow W_1^{(1)} \rightarrow W_0^{(1)} \\ & & & & & & \quad \quad \quad \downarrow \\ & & & & & & W_0^{(0)} \end{array}$$

by putting  $W^{(0)} = R$ ,  $W^{(1)} = B_{(1,1)}\varphi$ ,  $W^{(2)} = A_2\varphi[1]$ ,  $W^{(3)} = R[3]$ . Recall (see section 4) that  $B_{(1,1)}\varphi = \text{Ker}(\Lambda^2\varphi \xrightarrow{ev} R[1])$  and  $A_2\varphi = \text{Coker}(R[1] \xrightarrow{tr} S_2\varphi)$ . Observe that  $W^{(1)*} = W^{(2)}$ . The map  $W^{(1)} \rightarrow W^{(0)}$  is determined by  $\Lambda^2 E \rightarrow R$  which sends  $e_i \wedge e_j$  to  $Pf'(i,j)$ . From (1) it follows that the above map defines the map of complexes  $W^{(1)} \rightarrow W^{(0)}$ . By dualizing we get a map of complexes  $W^{(3)} \rightarrow W^{(2)}$ . To describe a map  $W^{(2)} \rightarrow W^{(1)}$  recall that  $S_2\varphi$  is a sub-complex of a differential graded algebra  $\Lambda(E^*) \otimes S(E)$  which is endowed with the structure of

*RESOLUTIONS OF DETERMINANTAL VARIETIES*

a differential Hopf algebra. Comultiplication in  $\Lambda(E^*) \otimes S(E)$  determines a map of complexes  $S_2\varphi \rightarrow \varphi \otimes \varphi$ . Similarly the algebra structure in  $S(E^*) \otimes \Lambda E$  determines a map of complexes  $\varphi \otimes \varphi \rightarrow \Lambda^2\varphi$ . Using them we define a map of complexes

$$S_2\varphi[1] \rightarrow \varphi \otimes \varphi \otimes S_2\varphi \rightarrow \varphi \otimes \varphi \otimes \varphi \otimes \varphi \rightarrow \Lambda^2\varphi \otimes \Lambda^2\varphi$$

where  $R[1] \rightarrow S_2\varphi$  is the trace map described at the beginning of section 4. One can easily check that it induces a map  $A_2\varphi[1] \rightarrow B_{(1,1)}\varphi \otimes B_{(1,1)}\varphi$ . Taking compositions with  $(B_{(1,1)}\varphi \rightarrow R) = (W^{(1)} \rightarrow W^{(0)})$  we get the required map of complexes  $d : W^{(2)} \rightarrow W^{(1)}$ . Explicitly

$$(4) \quad d_1(ij) = \sum_P Pf'(jp) i \otimes p^* + \sum_P Pf'(ip) j \otimes p^*$$

where  $k$  stands for  $e_k$  (for short);

$$(5) \quad d_2(i \otimes j^*) = \sum_P Pf'(ip) j^* p^* .$$

Observe that the total complex  $W(\varphi)$  associated with the double complex (3) is self-dual.

Theorem 5.4 [Józefiak-Pragacz]  $W(\varphi)$  is a minimal free resolution of  $R/Pf_{2p+2}(\varphi)$  where  $2p+2 = n-2$ .

Proof By Lemma 5.1 it suffices to check the exactness of (3) for the matrix

$$\varphi = \begin{pmatrix} 0 & 0 \\ 0 & 0 \end{pmatrix} \otimes \underbrace{\begin{pmatrix} 0 & 1 \\ -1 & 0 \end{pmatrix} \otimes \dots \otimes \begin{pmatrix} 0 & 0 \\ -1 & 0 \end{pmatrix}}_{p+1} .$$

Suppose that  $\psi$  is an isomorphism and  $\theta$  is arbitrary. It is easy to see that  $B_{(1,1)}(\theta + \psi)$  is an extension of  $\theta \otimes \psi + B_{(1,1)}(\theta)$  by  $\Lambda^2\psi$ . Since  $\theta \otimes \psi$  and  $\Lambda^2\psi$  are exact (because  $\psi$  is exact)  $H(B_{(1,1)}(\theta + \psi)) = H(B_{(1,1)}(\theta))$  and

the isomorphism is induced by the natural injection.

Applying this remark to

$$\theta = \begin{pmatrix} 0 & 0 \\ 0 & 0 \end{pmatrix}, \quad \psi = \begin{pmatrix} 0 & 1 \\ -1 & 0 \end{pmatrix} \otimes \dots \otimes \begin{pmatrix} 0 & 1 \\ -1 & 0 \end{pmatrix}, \quad \varphi = \theta \otimes \psi,$$

we infer that  $H_0(W^{(1)}(\varphi))$  is of rank 1 and is generated by  $1 \wedge 2$ ,  $H_1(W^{(1)}(\varphi))$  is of rank 3 with a basis  $1 \otimes 2^*$ ,  $2 \otimes 1^*$ ,  $1 \otimes 1^* - 2 \otimes 2^*$ , and  $H_2(W^{(1)}(\varphi))$  is of rank 3 with a basis  $1^*1^*$ ,  $1^*2^*$ ,  $2^*2^*$ . Similarly  $H(W^{(2)}(\varphi)) = H(W^{(2)}(\theta))$  so that  $H_1(W^{(2)}(\varphi))$  is of rank 3 with a basis  $11$ ,  $12$ ,  $22$ ,  $H_2(W^{(2)}(\varphi))$  is of rank 3 with a basis  $1 \otimes 2^*$ ,  $2 \otimes 1^*$ ,  $1 \otimes 1^*$ , and  $H_3(W^{(2)}(\varphi))$  is of rank 1 with a basis element  $1^* \wedge 2^*$ . By the formula (4)  $d_1$  sends

$$\begin{aligned} 11 & \text{ to } 2(1 \otimes 2^*), \\ 12 & \text{ to } 2 \otimes 2^* - 1 \otimes 1^*, \\ 22 & \text{ to } -2(2 \otimes 1^*), \end{aligned}$$

and therefore establishes an isomorphism  $H_1(W^{(2)}(\varphi)) \simeq H_1(W^{(1)}(\varphi))$ . Similarly, by the formula (5)  $d_2$  sends

$$\begin{aligned} 1 \otimes 2^* & \text{ to } 2^*2^*, \\ 2 \otimes 1^* & \text{ to } -1^*1^*, \\ 1 \otimes 1^* & \text{ to } 1^*2^*, \end{aligned}$$

and hence  $H_2(W^{(2)}(\varphi)) \simeq H_2(W^{(1)}(\varphi))$ .

Since moreover  $H_0(W^{(1)}(\varphi))$  is killed because  $1 \wedge 2$  is sent to 1 we infer that  $W(\varphi)$  is exact.

Remark The double complexes (2) and (3) should be compared with examples given in 3.5. A characteristic free version of Theorem 5.4 is discussed in [Pragacz].



$$(7) \quad \begin{array}{ccccccc} & & \Lambda^2 E \otimes S_2 E^* & & & & \\ & & \oplus & & & & \\ S_{22} E^* & \rightarrow & E \otimes S_{21} E^* & \rightarrow & \oplus & \rightarrow & S_{21} E \otimes E^* \rightarrow S_{22} E \\ & & & & S_2 E \otimes \Lambda^2 E^* & & \end{array}$$

and the maps in (7) are induced by  $\varphi$ .

We use a uniform notation for generators of various components in (7) by writing  $\begin{smallmatrix} z & t \\ x & y \end{smallmatrix}$  for the image of  $xy \otimes zt \in S_2 \varphi \otimes S_2 \varphi$  in  $S_{22} \varphi$  (so that  $x, y, z, t$  may belong to  $E$  or  $E^*$ ). For example,  $\begin{smallmatrix} a^* & b^* \\ x & y \end{smallmatrix} \in S_2 E \otimes \Lambda^2 E^*$ ,  $\begin{smallmatrix} y & b^* \\ x & a^* \end{smallmatrix} \in \Lambda^2 E \otimes S_2 E^*$  for  $x, y \in E$ ,  $a^*, b^* \in E$ . We apply the same convention to other Schur complexes. For instance, a typical generator of a component of  $\Lambda^3 \varphi$  has the form  $\begin{smallmatrix} z \\ y \\ x \end{smallmatrix}$  meaning that  $\begin{smallmatrix} z \\ y \\ x \end{smallmatrix} \in \Lambda^3 E$  if  $x, y, z \in E$ ,  $\begin{smallmatrix} z \\ y \\ x \end{smallmatrix} \in S_3 E^*$  if  $x, y, z \in E^*$ , etc.

Using our standard trace map  $R[1] \rightarrow S_2 \varphi$  we get a map  $S_2 \varphi[1] \rightarrow S_2 \varphi \otimes S_2 \varphi \rightarrow S_{22} \varphi$ . On the other hand we have a map

$$S_2 \varphi \otimes S_2 \varphi \rightarrow \varphi \otimes \varphi \otimes \varphi \otimes \varphi \rightarrow \Lambda^2 \varphi \otimes \Lambda^2 \varphi$$

which induces  $S_{22} \varphi \rightarrow \Lambda^2 \varphi \otimes \Lambda^2 \varphi$ . The composition with the evaluation map  $\Lambda^2 \varphi \rightarrow R[1]$  gives us a map  $S_{22} \varphi \rightarrow \Lambda^2 \varphi[1]$ . It turns out that the composition  $S_2 \varphi[1] \rightarrow S_{22} \varphi \rightarrow \Lambda^2 \varphi[1]$  is zero and we define  $W^{(2)}$  as the homology complex of this sequence shifted by 1. Observe that  $W^{(2)}$  is self-dual because  $S_{22} \varphi$  is so (since  $\varphi$  is antisymmetric).

We should still define maps between rows of (6).  $W^{(1)} \rightarrow W^{(0)}$  is determined by a map  $\Lambda^3 E \rightarrow R$  sending  $i \wedge j \wedge k$  to  $\text{Pf}'(i, j, k)$ . It follows from (1) that this really defines a map of complexes  $W^{(1)} \rightarrow W^{(0)}$ . By duality we get a map  $W^{(4)} \rightarrow W^{(3)}$ .

To describe  $W^{(2)} \rightarrow W^{(1)}$  let us consider the map of complexes

*RESOLUTIONS OF DETERMINANTAL VARIETIES*

$$(8) \quad S_{22}\varphi[1] \rightarrow \Lambda^2\varphi \otimes \Lambda^2\varphi \otimes S_2\varphi \rightarrow \Lambda^2\varphi \otimes \Lambda^2\varphi \otimes \varphi \otimes \varphi \rightarrow \Lambda^3\varphi \otimes \Lambda^3\varphi$$

The map (8) sends  $\begin{matrix} z & t \\ x & y \end{matrix}$  to

$$\begin{aligned} & \sum \begin{matrix} p & p^* \\ z & t \\ p & x & y \end{matrix} + \sum \begin{matrix} p & p^* \\ t & z \\ p & y & x \end{matrix} + \sum \begin{matrix} p & p^* \\ z & t \\ p & y & x \end{matrix} + \sum \begin{matrix} p & p^* \\ t & z \\ p & x & y \end{matrix} + \\ & \sum \begin{matrix} p^* & p \\ z & t \\ p & x & y \end{matrix} + \sum \begin{matrix} p^* & p \\ t & z \\ p & y & x \end{matrix} + \sum \begin{matrix} p^* & p \\ z & t \\ p & y & x \end{matrix} + \sum \begin{matrix} p^* & p \\ t & z \\ p & x & y \end{matrix} \end{aligned}$$

Denote by  $\langle x, y \rangle$  the image of  $x \otimes y \in E \otimes E^*$  under the evaluation map and extend the inner product by putting  $\langle x, y \rangle = 0$  if  $x, y \in E$  or  $x, y \in E^*$ . Look at the map  $\Lambda^3\varphi \otimes \Lambda^3\varphi \rightarrow \Lambda^3\varphi \otimes \varphi[1]$  induced by the evaluation map  $\Lambda^2\varphi \rightarrow R[1]$ . It sends  $\sum \begin{matrix} p & p^* \\ z & t \\ p & x & y \end{matrix}$  to

$$(9) \quad \sum \begin{matrix} p \\ z \\ p & x \end{matrix} \otimes \langle p^*, t \rangle y - \sum \begin{matrix} p \\ z \\ p & x \end{matrix} \otimes \langle p^*, y \rangle t + \sum \begin{matrix} p \\ z \\ p & x \end{matrix} \otimes \langle y, t \rangle p^*$$

which is equal to

$$(10) \quad \begin{matrix} t & y \\ z & z \\ x & y \end{matrix} - \begin{matrix} y \\ z \\ x & t \end{matrix} \quad \text{if } y, t \in E .$$

In this case (i.e. in the zero component) the composition

$$(11) \quad S_{22}\varphi[1] \rightarrow \Lambda^3\varphi \otimes \Lambda^3\varphi \rightarrow \Lambda^3\varphi \otimes \varphi[1]$$

is zero since various summands of type (10) cancel. In the other components this is not so; however the elements from  $\text{Ker}(S_{22}\varphi[1] \rightarrow \Lambda^2\varphi[2])$  are sent by (11) to zero since the sum of various summands of type  $\sum \begin{matrix} p \\ z \\ p & x \end{matrix} \otimes \langle y, t \rangle p^*$  in (9) is zero by assumption. This shows that we have a well-defined map of complexes



$$\text{Ker} (S_{22}\varphi[1] \rightarrow \Lambda^2\varphi[2]) \rightarrow W^{(1)} \otimes W^{(1)}$$

and hence

$$(12) \quad \text{Ker} (S_{22}\varphi[1] \rightarrow \Lambda^2\varphi[2]) \rightarrow W^{(1)}$$

by using  $W^{(1)} \rightarrow W^{(0)}$ . This map is zero on  $\text{Im}(S_{22}\varphi[2] \rightarrow S_{22}\varphi[1])$ .

Indeed, a typical element of this image is of the form

$$\sum_p \begin{pmatrix} p & p^* \\ x & y \end{pmatrix}. \text{ It is sent by (12) into}$$

$$\sum_p \left( \sum_q \text{Pf}'(x,p,q) \begin{pmatrix} q^* \\ p^* \\ y \end{pmatrix} + \sum_q \text{Pf}'(y,p,q) \begin{pmatrix} q^* \\ p^* \\ x \end{pmatrix} \right).$$

This is zero because  $\text{Pf}'(x,p,q) \begin{pmatrix} q^* \\ p^* \\ y \end{pmatrix} + \text{Pf}'(x,q,p) \begin{pmatrix} p^* \\ q^* \\ y \end{pmatrix} = 0$

for fixed  $p,q$ . In fact  $\text{Pf}'$  is an alternating function of

its arguments and  $\begin{pmatrix} q^* \\ p^* \\ y \end{pmatrix} = \begin{pmatrix} p^* \\ q^* \\ y \end{pmatrix}$ .

The above discussion shows that (12) induces a map of complexes  $d : W^{(2)} \rightarrow W^{(1)}$ . We specify this map on some components for future application. Observe that  $W_1^{(2)} = S_{22}E$  and

$$(13) \quad d_1 \begin{pmatrix} k & l \\ i & j \end{pmatrix} = \sum_p \text{Pf}'(i,j,p) \begin{pmatrix} k \\ i \\ p \end{pmatrix} \otimes p^* + \sum_p \text{Pf}'(i,k,p) \begin{pmatrix} l \\ j \\ p \end{pmatrix} \otimes p^* + \\ + \sum_p \text{Pf}'(i,l,p) \begin{pmatrix} k \\ j \\ p \end{pmatrix} \otimes p^* + \sum_p \text{Pf}'(j,k,p) \begin{pmatrix} l \\ i \\ p \end{pmatrix} \otimes p^* .$$

$W_2^{(2)}$  is the homology module of the sequence  $S_2E \rightarrow S_{21}E \otimes E^* \rightarrow \Lambda^2E$  and

$$(14) \quad d_2 \begin{pmatrix} k & l^* \\ i & j \end{pmatrix} = \sum_p \text{Pf}'(i,k,p) \begin{pmatrix} j \\ i \\ p \end{pmatrix} \otimes p^* l^* + \sum_p \text{Pf}'(j,k,p) \begin{pmatrix} i \\ j \\ p \end{pmatrix} \otimes p^* l^*$$

We define  $W^{(3)} \rightarrow W^{(2)}$  as the dual map to  $W^{(2)} \rightarrow W^{(1)}$ . More explicitly it is induced by the map of complexes

$$S_3\varphi \otimes S_3\varphi \rightarrow S_2\varphi \otimes \varphi \otimes S_2\varphi \otimes \varphi \rightarrow S_{22}\varphi[1]$$

and  $W^{(4)} \rightarrow W^{(3)}$ .

Theorem 5.5 The total complex  $W(\varphi)$  of the double complex (6) is a minimal free resolution of  $R/Pf_{2p+2}(\varphi)$  where  $2p+2 = n-3$ .

Proof By Lemma 5.1 it suffices to check the exactness of (6) for the matrix  $\varphi = \theta \otimes \psi$  where  $\psi = \underbrace{\begin{pmatrix} 0 & 1 \\ -1 & 0 \end{pmatrix} \otimes \dots \otimes \begin{pmatrix} 0 & 1 \\ -1 & 0 \end{pmatrix}}_{p+1}$ ,  $\theta = \begin{pmatrix} 0 & 0 & 0 \\ 0 & 0 & 0 \\ 0 & 0 & 0 \end{pmatrix}$ . We will do it by checking that for such a matrix

$\varphi$  the maps between rows of (6) induce exact sequences of the homology of rows. By standard spectral sequence arguments this implies the exactness of  $W(\varphi)$ .

The idea of our proof is the same as that of Theorem 5.4, i.e. we need to know that

Lemma 5.6  $H(W^{(i)}(\varphi)) \simeq H(W^{(i)}(\theta))$  for  $i = 0, \dots, 4$ .

Proof of the lemma For  $i = 0, 4$  this is trivial, and for  $i = 1, 3$  it is a simple calculation using arguments similar to those given in the course of the proof of Theorem 5.4. We will concentrate our efforts on the case  $i = 2$ .

Look at the sequence of complexes

$$(15) \quad R[2] \rightarrow S_2(\theta + \psi)[1] \rightarrow S_{22}(\theta + \psi) \rightarrow \Lambda^2(\theta + \psi)[1] \rightarrow R[2] .$$

We compare its middle homology complex  $W^{(2)}(\theta + \psi)$  with  $W^{(2)}(\theta)$ . By the linearity formula (2.2), which is valid also for Schur complexes, we have

$$S_{22}(\theta + \psi) = S_{22}\theta + S_{21}\theta \otimes \psi + S_2\theta \otimes S_2\psi + \Lambda^2\theta \otimes \Lambda^2\psi + \theta \otimes S_{21}\psi + S_{22}\psi .$$

There is a direct summand of (15) of the form

$$(16) \quad \begin{array}{ccc} & \nearrow & \\ \theta \otimes \psi[1] & & S_{21}\theta \otimes \psi \\ & \searrow & \\ & & \theta \otimes S_{21}\psi \end{array} \quad \begin{array}{c} + \\ \\ + \end{array} \quad \begin{array}{ccc} & \nearrow & \\ \theta \otimes \psi[1] & & \\ & \searrow & \end{array}$$

whose homology in the middle is an exact complex because all the complexes involved in (16) are exact. Indeed,  $\psi$  and  $S_{21}\psi$  are exact since  $\psi$  is an isomorphism, see [Akin-Buchsbaum-Weyman]. Therefore we can restrict ourselves to the remaining part of (15).

Using the decomposition  $S_2(\theta + \psi) = S_2\theta + \theta \otimes \psi + S_2\psi$  and an analogous one for  $\Lambda^2(\theta + \psi)$  we can write (15) as follows (except the part thrown out):

$$(17) \quad \begin{array}{ccccccc} & & & S_{22}\psi & & & \\ & & & \nearrow & & \searrow & \\ & & & + & & & \\ R[2] & \nearrow & S_2\psi[1] & \rightarrow & S_2\theta \otimes S_2\psi & \rightarrow & \Lambda^2\psi[1] \\ & \searrow & + & & + & & + \\ & & S_2\theta[1] & \nearrow & \Lambda^2\theta \otimes \Lambda^2\psi & \rightarrow & \Lambda^2\theta[1] \\ & & & \searrow & & & \searrow \\ & & & + & & & \\ & & & S_{22}\theta & & & \\ & & & \nearrow & & & \\ & & & & & & R[2] \end{array}$$

Write B for the complex of complexes (17) which is exact except possibly in the middle. There exists a subcomplex A of B

$$A : \quad \begin{array}{ccc} & \nearrow & \\ S_2\theta[1] & & S_2\theta \otimes S_2\psi \\ & \searrow & \\ & & S_{22}\theta \end{array} \quad \begin{array}{c} + \\ \\ + \end{array} \quad \begin{array}{ccc} & \nearrow & \\ \Lambda^2\theta[1] & \rightarrow & R[2] \\ & \searrow & \end{array}$$

with a factor complex

$$C : \quad R[2] \rightarrow S_2\psi[1] \rightarrow \begin{array}{c} S_{22}\psi \\ + \\ \Lambda^2\theta \otimes \Lambda^2\psi \end{array} \rightarrow \Lambda^2\psi[1]$$

The exact sequence of the double complexes  $0 \rightarrow A \rightarrow B \rightarrow C \rightarrow 0$  induces the exact sequence of complexes  $0 \rightarrow H(A) \rightarrow H(B) \rightarrow H(C) \rightarrow 0$  where  $H(D)$  means the homology complex in the middle of  $D$ . Moreover by a simple inspection we infer that there exist exact sequences of complexes

$$0 \rightarrow S_2\theta \otimes S_2\psi/R[2] \rightarrow H(A) \rightarrow W^{(2)}(\theta) \rightarrow 0$$

and

$$0 \rightarrow W^{(2)}(\psi) \rightarrow H(C) \rightarrow \text{Ker} (\Lambda^2\theta \otimes \Lambda^2\psi \rightarrow R[2]) \rightarrow 0 .$$

By direct computation one shows that the only non-vanishing homology of  $H(C)$  is of rank 1 and appears in degree 4. Moreover the homology of  $H(A)$  is that of  $W^{(2)}(\theta)$  except for one place in degree 3 where they differ by a module of rank 1. These two homology modules of rank 1 are sent isomorphically by the connecting homomorphism of the long exact homology sequence associated with the sequence of complexes  $0 \rightarrow H(A) \rightarrow H(B) \rightarrow H(C) \rightarrow 0$ , thus establishing an isomorphism between homology of  $W^{(2)}(\theta)$  and that of  $H(B)$ . However  $W^{(2)}(\theta + \psi)$  differs from  $H(B)$  by an exact complex (according to our previous discussion) so we are done.

Proof of Theorem 5.5 (Continuation) Coming back to (6) we are going to show that the maps between rows induce isomorphisms on the homology of rows for  $\varphi = \theta \otimes \psi$ . Note that

Pf (1,2,3) = 1 and all other pfaffians vanish for such a  $\varphi$ . Moreover by Lemma 5.6  $H_1(W^{(2)}(\varphi)) \simeq S_{22} R^3$  is of rank 6 (see (2.12)) and  $H_1(W^{(1)}(\varphi)) \simeq H_1(W^{(1)}(\theta)) \subset \Lambda^2(R^3) \otimes (R^3)^*$  is also of rank 6. By (13) one can check that the following elements (which form bases of the corresponding homology modules) are sent to each other under  $H_1(W^{(2)}(\varphi)) \rightarrow H_1(W^{(1)}(\varphi))$ :

$$\begin{array}{l} \begin{array}{l} 22 \\ 11 \end{array} \longmapsto 4 \begin{pmatrix} 2 \\ 13^* \end{pmatrix} \\ \\ \begin{array}{l} 33 \\ 11 \end{array} \longmapsto -4 \begin{pmatrix} 3 \\ 12^* \end{pmatrix} \\ \\ \begin{array}{l} 33 \\ 22 \end{array} \longmapsto 4 \begin{pmatrix} 3 \\ 21^* \end{pmatrix} \\ \\ \begin{array}{l} 23 \\ 11 \end{array} \longmapsto 2 \begin{pmatrix} 1 \\ 22^* \end{pmatrix} - \begin{pmatrix} 1 \\ 33^* \end{pmatrix} \\ \\ \begin{array}{l} 23 \\ 12 \end{array} \longmapsto \begin{pmatrix} 2 \\ 11^* \end{pmatrix} - \begin{pmatrix} 2 \\ 33^* \end{pmatrix} \\ \\ \begin{array}{l} 33 \\ 12 \end{array} \longmapsto 2 \begin{pmatrix} 3 \\ 11^* \end{pmatrix} - \begin{pmatrix} 3 \\ 22^* \end{pmatrix}, \end{array}$$

thus establishing the required isomorphism.

$H_2(W^{(2)}(\varphi)) \simeq H_2(W^{(2)}(\theta))$  is of rank 15 as is  $H_2(W^{(1)}(\varphi)) \simeq H_2(W^{(1)}(\theta))$ . The following list specifies bases of both modules showing pairs of the corresponding elements under  $H_2(W^{(2)}(\varphi)) \rightarrow H_2(W^{(1)}(\varphi))$  (see the formula (14)).

$$\begin{array}{l} \begin{array}{l} 32^* \\ 11 \end{array} \longmapsto -2 (1 \otimes 2^*2^*) \\ \\ \begin{array}{l} 22^* \\ 11 \end{array} \longmapsto 2 (1 \otimes 2^*3^*) \\ \\ \begin{array}{l} 23^* \\ 11 \end{array} \longmapsto 2 (1 \otimes 3^*3^*) \end{array}$$

RESOLUTIONS OF DETERMINANTAL VARIETIES

$$\begin{array}{lcl}
 31^* & & \\
 22 & \longmapsto & 2 (2 \otimes 1^*1^*) \\
 \\ 
 33^* & & \\
 22 & \longmapsto & 2 (2 \otimes 1^*3^*) \\
 \\ 
 23^* & & \\
 12 & \longmapsto & 2 \otimes 3^*3^* \\
 \\ 
 31^* & & \\
 23 & \longmapsto & 3 \otimes 1^*1^* \\
 \\ 
 32^* & & \\
 23 & \longmapsto & 3 \otimes 1^*2^* \\
 \\ 
 32^* & & \\
 13 & \longmapsto & - 3 \otimes 2^*2^* \\
 \\ 
 22^* & & \\
 13 & \longmapsto & 3 \otimes 3^*2^* - 1 \otimes 1^*2^* \\
 \\ 
 33^* & & \\
 12 & \longmapsto & 1 \otimes 1^*3^* - 2 \otimes 2^*3^* \\
 \\ 
 11^* & & \\
 23 & \longmapsto & 2 \otimes 2^*1^* - 3 \otimes 3^*1^* \\
 \\ 
 31^* & & \\
 21 & \longmapsto & 1 \otimes 1^*1^* - 2 \otimes 2^*1^* \\
 \\ 
 23^* & & \\
 13 & \longmapsto & 3 \otimes 3^*3^* - 1 \otimes 1^*3^* \\
 \\ 
 12^* & & \\
 32 & \longmapsto & 2 \otimes 2^*2^* - 3 \otimes 3^*2^*
 \end{array}$$

Using Lemma 5.6 once more, one computes that  $\text{rank } H_3(W^{(2)}(\varphi)) = 20$  and  $\text{rank } H_3(W^{(1)}(\varphi)) = \text{rank } H_3(W^{(3)}(\varphi)) = 10$ . An analysis similar to the previous one proves the exactness of the sequence  $0 \rightarrow H_3(W^{(3)}(\varphi)) \rightarrow H_3(W^{(2)}(\varphi)) \rightarrow H_3(W^{(1)}(\varphi)) \rightarrow 0$ .

Finally  $H_0(W^{(1)}(\varphi)) \simeq \Lambda^3(\mathbb{R}^3)$  and because  $1 \wedge 2 \wedge 3 \mapsto \text{Pf}(1,2,3) = 1$  the map  $H_0(W^{(1)}(\varphi)) \rightarrow \mathbb{R}$  is an isomorphism, too. Since (6) is self-dual we are done.

From now on the map  $\varphi : E^* \rightarrow E$  is supposed to be symmetric and determined by the  $n \times n$  matrix of indeterminates  $T$ . The symmetry of  $\varphi$  is equivalent to the statement that the evaluation map  $S_2\varphi \rightarrow R[1]$  is a map of complexes; we have also the dual trace map  $R[1] \rightarrow \Lambda^2\varphi$  (see section 4).

Let us write  $W^{(0)} = R$ ,  $W^{(1)} = \text{Ker}(S_2\varphi \rightarrow R[1]) = B_{(1,1)}\varphi$  and define a map  $W^{(1)} \rightarrow W^{(0)}$  which is determined by the map  $S_2E \rightarrow R$  sending  $ij$  to  $(-1)^{i+j} M(i;j)$ . Here  $M(i;j)$  is the minor of  $T$  obtained from  $T$  by leaving out the  $i$ -th row and the  $j$ -th column. From the Laplace expansion it follows that this is really a map of complexes.

Theorem 5.7 [Goto-Tachibana], [Józefiak] If  $r+1 = n-1$ , then the complex  $W^{(1)} \rightarrow W^{(0)}$  is a minimal free resolution of  $R/I_{r+1}(\varphi)$ .

Proof By Lemma 5.2 it suffices to check the exactness for the matrix  $\varphi = \theta \oplus \psi$  where  $\theta = (0)$ ,  $\psi = (1) \underbrace{\oplus \dots \oplus}_{r+1} (1)$ . Since again  $H(W^{(1)}(\varphi)) = H(W^{(1)}(\theta))$  this implies that  $H_1(W^{(1)}(\varphi)) = H_2(W^{(1)}(\varphi)) = 0$ . In a similar way as before we also infer that  $H_0(W^{(1)}(\varphi))$  (which is of rank 1) is killed by the map  $W^{(1)} \rightarrow W^{(0)}$ .

Finally we treat the case  $r+1 = n-2$ , which leads to a resolution of length 6.

Consider the map of complexes  $\Lambda^3\varphi \otimes \varphi \xrightarrow{\alpha} \Lambda^2\varphi \otimes \Lambda^2\varphi$  which is the composition  $\Lambda^3\varphi \otimes \varphi \rightarrow \Lambda^2\varphi \otimes \varphi \otimes \varphi \rightarrow \Lambda^2\varphi \otimes \Lambda^2\varphi$  and observe that  $\Lambda_{22}\varphi = \text{Coker } \alpha$ . The situation is similar to that discussed in the course of the construction of the length 10 complex in the antisymmetric case. Once again we

have a complex of complexes

$$\Lambda^2 \varphi[1] \rightarrow \Lambda_{22} \varphi \rightarrow S_2 \varphi[1]$$

coming from maps  $R[1] \rightarrow \Lambda^2 \varphi$  and  $S_2 \varphi \rightarrow R[1]$  and we define  $W^{(1)}$  as the homology of this complex. Observe that it is self-dual. Moreover we put  $W^{(0)} = R$ ,  $W^{(2)} = R[5]$ . A map of complexes  $W^{(1)} \rightarrow W^{(0)}$  is determined by the map of modules  $\Lambda_{22} E \rightarrow R$  which sends a typical basis element  $\begin{smallmatrix} j & l \\ i & k \end{smallmatrix}$  to a minor  $\pm M(i,j;k,l)$  obtained from  $T$  by leaving out the  $i,j$ -th rows and the  $k,l$ -th columns. One checks that this really leads to a map of complexes  $W^{(1)} \rightarrow W^{(0)}$ . By duality we also get a map  $W^{(2)} \rightarrow W^{(1)}$ .

Theorem 5.8 If  $r+1 = n-2$ , then the complex  $W(\varphi)$  is a minimal free resolution of  $R/I_{r+1}(\varphi)$ .

Proof Again by Lemma 5.2 we check the exactness of  $W(\varphi)$  for  $\varphi = \theta \oplus \psi$  where  $\theta = \begin{pmatrix} 0 & 0 \\ 0 & 0 \end{pmatrix}$ ,  $\psi = (1) \underbrace{\oplus \dots \oplus}_{r+1} (1)$ .

Since, as in Lemma 5.6,  $H(W^{(1)}(\varphi)) \simeq H(W^{(1)}(\theta))$  we infer that  $H_1 = H_2 = H_3 = 0$ . Moreover the one-dimensional  $H_0(W^{(1)}(\varphi))$  is killed by  $W^{(1)} \rightarrow W^{(0)}$ . Duality implies the exactness of  $W(\varphi)$ .



REFERENCES

- K. Akin, D. Buchsbaum, J. Weyman, Schur functors and Schur complexes, *Adv. in Math.* (to appear)
- D. Buchsbaum, D. Eisenbud, Algebra structures for finite free resolutions, and some structure theorems for ideals of codimension 3, *Amer. J. Math.* 99 (1977), 447-485
- C. De Concini, E. Strickland, Traceless tensors and the symmetric group, *J. of Algebra*, 61 (1979), 112-128
- C. De Concini, C. Procesi, A characteristic free approach to invariant theory, *Adv. in Math.* 21 (1976), 330-354
- S. Goto, S. Tachibana, A complex associated with a symmetric matrix, *J. Math. Kyoto Univ.* 17 (1977), 51-54
- T. Józefiak, Ideals generated by minors of a symmetric matrix, *Comment. Math. Helv.* 53 (1978), 595-607
- T. Józefiak, P. Pragacz, Syzygies de Pfaffiens, *C.R. Acad. Sci. Paris* 287 (1978), 89-91
- T. Józefiak, P. Pragacz, Ideals generated by Pfaffians, *J. of Algebra* 61 (1979), 189-198
- G. Kempf, Thesis, Harvard (1971)
- G. Kempf, On the collapsing of homogeneous bundles, *Inv. math.* 37 (1976), 229-239
- G. Kempf, D. Laksov, The determinantal formula of Schubert calculus, *Acta Math.* 132 (1974), 153-162
- H. Kleppe, D. Laksov, The algebra structure and deformation of pfaffian schemes, *J. of Algebra* 64 (1980), 167-189
- R.E. Kutz, Cohen-Macaulay rings and ideal theory in rings of invariants of algebraic groups, *Trans. A.M.S.* 194 (1974), 115-129

*RESOLUTIONS OF DETERMINANTAL VARIETIES*

- D. Laksov, Deformation and transversality, in "Algebraic geometry, Proceedings, Copenhagen 1978", Lecture Notes in Math., No. 732, Springer-Verlag (1979), 300-316
- A. Lascoux, Syzygies des variétés déterminantales, Adv. in Math. 30 (1978), 202-237
- A. Lascoux, Syzygies pour les mineurs de matrices symetriques, Preprint, Paris (1977)
- A. Lascoux, M.-P. Schützenberger, Le Monoïde Plaxique, Napoli 1978, (to appear in Quaderni della Ricerca Scientifica)
- I.G. Macdonald, Symmetric functions and Hall polynomials, Clarendon Press, Oxford (1979)
- H.A. Nielsen, Tensor functors of complexes, Aarhus University Preprint No. 15 (1977/78)
- C. Peskine, L. Szpiro, Dimension projective finie et cohomologie locale, I.H.E.S. Publ. Math. 42 (1973), 323-395
- P. Pragacz, Thesis, Toruń (1981)
- P. Pragacz, Characteristic free resolution of  $(n-2)$ -order Pfaffians of  $n \times n$  antisymmetric matrix, (in preparation)
- P. Roberts, A minimal free complex associated to the minors of a matrix, Preprint
- M.-P. Schützenberger, La correspondance de Robinson, in "Combinatoire et Représentation du Groupe Symétrique", Lecture Notes in Math. No. 579, Springer Verlag (1977), 59-113
- G.P. Thomas, On Schensted's construction and the multiplication of Schur functions, Adv. in Math. 30 (1978), 8-32
- J. Towber, Two new functors from modules to algebras, J. of Algebra 47 (1977), 80-104
- H. Weyl, The classical groups, 2nd ed., Princeton Univ. Press, Princeton (1946)

Institute of Mathematics, Polish Academy of Sciences  
Institute of Mathematics, N. Copernicus University  
Chopina 12, 87-100 Toruń, Poland