

Astérisque

ALLEN E. HATCHER

JOHN B. WAGONER

Pseudo-isotopies of compact manifolds

Astérisque, tome 6 (1973)

http://www.numdam.org/item?id=AST_1973__6__1_0

© Société mathématique de France, 1973, tous droits réservés.

L'accès aux archives de la collection « Astérisque » (<http://smf4.emath.fr/Publications/Asterisque/>) implique l'accord avec les conditions générales d'utilisation (<http://www.numdam.org/conditions>). Toute utilisation commerciale ou impression systématique est constitutive d'une infraction pénale. Toute copie ou impression de ce fichier doit contenir la présente mention de copyright.

NUMDAM

Article numérisé dans le cadre du programme
Numérisation de documents anciens mathématiques

<http://www.numdam.org/>

TABLE OF CONTENTS

PART I. THE FIRST OBSTRUCTION FOR PSEUDO-ISOTOPIES.

INTRODUCTION

CHAPTER I. Pseudo-isotopies and real valued functions.....	p 16
§1. Cerf's functional approach to pseudo-isotopies.....	p 17
§2. The stratification of \mathcal{F}	p 20
§3. Gradient-like vector fields.....	p 32
§4. General position of nice gradient-like vector fields.	p 51
§5. Suspension.....	p 54
§6. Independence of birth and death points.....	p 62
§7. Independent trajectories.....	p 64
§8. One and two parameter ordering.....	p 68
CHAPTER II. Geometry of the Steinberg group.	
§1. Geometric realization of the Steinberg group.....	p 79
§2. Multi-level Steinberg words.....	p 98
CHAPTER III. More about Wh_2 .	
§1. Presentations of Wh_2	p 103
§2. Relations in the Steinberg group.....	p 109
§3. Construction of $\Sigma : \Omega \rightarrow Wh_2$	p 118
CHAPTER IV. The Wh_2 invariant for pseudo-isotopies.	
§1. Definition of $\Sigma : \pi_0(\mathcal{F}) \rightarrow Wh_2$	p 126
§2. The three basic relations	p 131

§3.	$\Sigma : \pi_0(\mathbb{O}) \rightarrow Wh_2$ is well-defined	p 156
CHAPTER V. Deformations of the graphic.		
§1.	Cancelling critical points.....	p 172
§2.	Introducing critical points.....	p 180
§3.	Two indices	p 184
§4.	The butterfly and the elliptic umbilic.....	p 199
§5.	Eliminating all dovetails	p 206
§6.	The two index definition of Σ	p 208
CHAPTER VI. The kernel of Σ		
CHAPTER VII. The $Wh_1(\pi_1 M; Z_2 \times \pi_2 M)$ invariant for pseudo-		
	isotopies.....	p 220
CHAPTER VIII. Product and duality formulae		p 231
REFERENCES		p 236
PART II. THE SECOND OBSTRUCTION FOR PSEUDO-ISOTOPIES		
§0.	Introduction	p 240
§1.	Algebraic preliminaries.....	p 240
§2.	Definition of the $Wh_1(\pi_1; Z_2 \times \pi_2)$ obstruction θ ...	p 244
§3.	Proof that θ is well-defined	p 256
§4.	Product and duality formulae ; Applications.....	p 264
§5.	Pseudo-isotopy versus isotopy	p 271
	References	p 275

PREFACE

The two papers in this volume compute the components of the space of pseudo-isotopies of a compact manifold of dimension at least seven and the main result can be viewed as a third step in relating differential topology to algebraic K-theory. Historically, the first step was Whitehead's theory of simple homotopy types, the Franz-Reidemeister torsion invariant, and then later Smale's h-cobordism theorem and its generalization to the non-simply connected case ; namely, the s-cobordism theorem of Barden-Mazur-Stallings, which showed how the Whitehead group measured the obstruction to putting a product structure on an h-cobordism. Next, work of Browder-Levine-Livesay followed by work of Siebenmann, of Golo, and of Wall in the non-simply connected case showed how the Grothendieck group K_0 of the category of finitely generated, projective modules gave the obstructions to putting a boundary on an open manifold. On the algebraic side Serre showed that algebraic vector bundles over an affine variety correspond to finitely generated projective modules over its coordinate ring. Then Swan showed that the Atiyah-Hirzebruch group of virtual vector bundles over a compact space was just K_0 for the ring of continuous functions on that space. Bass studied the functor K_1 on rings, of which the Whitehead group is a suitable quotient, and showed how to fit K_0 and K_1 into an exact sequence similar to the one in the Atiyah-Hirzebruch K-theory. Consequently, a feeling emerged that there must be an "algebraic" K-theory concerned with an appropriate sequence of functors K_0, K_1, K_2 , etc. Such a theory has recently been developed and is an active area of research. The third step began on the geometric side with Cerf's theorem that pseudo-isotopy implies isotopy in the simply connected case in dimensions at least five. Just as the s-cobordism theorem was related to the uniqueness of putting a boundary on an open manifold, the pseudo-isotopy problem measures the

uniqueness of a product structure on a trivial h-cobordism and it seemed natural that a non-simply connected version of Cerf's result would be related to a functor K_2 . Around 1967 Milnor defined a K_2 group along the lines of Steinberg's work on universal coverings of Chevalley groups and this turned out to be what was needed. However, unlike the previous two geometric problems corresponding to K_0 and K_1 the non-simply connected pseudo-isotopy theorem requires a second obstruction which depends not only on the fundamental group but on the second homotopy group as well. For a precise statement of the result see the Introduction to Part I of this volume.

PREFACE (*)

Les deux articles ici réunis aboutissent à la détermination complète de l'ensemble des composantes connexes de l'espace des pseudo-isotopies de toute variété compacte de dimension au moins sept ; le résultat final peut être considéré comme établissant la troisième relation connue entre la topologie différentielle et la K-théorie algébrique.

Historiquement, la première étape fut constituée par la théorie du type d'homotopie simple de Whitehead, la définition de l'invariant de torsion par Franz et Reidemeister, puis beaucoup plus tard le théorème du h-cobordisme de Smale et sa généralisation au cas non simplement connexe, appelée "théorème du s-cobordisme de Barden-Mazur-Stallings" ; ce théorème montrait comment le groupe de Whitehead mesurait l'obstruction à munir un h-cobordisme d'une structure de produit.

Seconde étape, des travaux de Browder-Levine-Livesay, puis de Siebenmann, Golo, et Wall dans le cas non simplement connexe, montrèrent comment le groupe de Grothendieck K_0 de la catégorie des modules projectifs de type fini fournissait les obstructions à munir d'un bord une variété ouverte. Du côté de l'algèbre, Serre montra que les fibrés vectoriels algébriques sur une variété affine correspondaient aux modules projectifs de type fini sur l'anneau de coordonnées de la variété. Puis Swan montra que le groupe d'Atiyah-Hirzebruch des fibrés vectoriels virtuels de base un espace compact n'était autre que le K_0 de l'anneau des fonctions continues sur cet espace. Bass étudia le foncteur K_1 sur les anneaux (le groupe de Whitehead d'un groupe π est un certain quotient du K_1 de l'anneau $Z[\pi]$) et montra comment

(*) Version française de la "Preface" des auteurs.

faire entrer K_0 et K_1 dans une suite exacte analogue à celle de la K-théorie d'Atiyah-Hirzebruch. A la suite de ces travaux l'impression se fit jour qu'il devait exister une "K-théorie algébrique" qui traitât d'une certaine suite de foncteurs K_0 , K_1 , K_2 , ... , etc. Une telle théorie s'est en effet développée ces dernières années, et elle est actuellement la matière d'actives recherches.

La troisième étape débuta du côté de la géométrie par le théorème de Cerf d'après lequel "pseudo-isotopie entraîne isotopie" dans le cas des variétés simplement connexes de dimension au moins cinq. De même que le théorème du s-cobordisme résoud le problème d'unicité correspondant au problème de "munir d'un bord une variété ouverte" , de même le problème de la pseudo-isotopie est celui de l'unicité de la structure de produit sur un h-cobordisme trivial. Il semblait donc naturel qu'une version "non-simplement connexe" du résultat de Cerf mit en jeu un foncteur K_2 . Vers 1967, Milnor, s'inspirant des travaux de Steinberg sur le revêtement universel des groupes de Chevalley, définissait un groupe K_2 , et cette notion se révéla par la suite être exactement celle dont on avait besoin. Mais contrairement au cas des deux problèmes géométriques précédents, qui correspondent au K_0 et au K_1 , l'énoncé du théorème de pseudo-isotopie dans le cas non simplement connexe fait intervenir, outre le K_2 , une "seconde obstruction", laquelle dépend non seulement du groupe fondamental mais aussi du second groupe d'homotopie. Pour un énoncé précis du résultat, le lecteur se reportera à l'Introduction de la première partie de ce volume.

ACKNOWLEDGEMENTS

Our methods are an extension of those of J. Cerf, who showed that "pseudo-isotopy implies isotopy" for simply connected manifolds of dimension at least five. It is a pleasure to thank Cerf together with A. Chenciner and F. Laudenbach whose work in this subject was of great help in the preparation of this volume. Thanks also go to Marnie McElhiney, who typed the manuscript.

Princeton University
University of California,
Berkeley

November 1972

PART I

PSEUDO-ISOTOPIES OF NON-SIMPLY
CONNECTED MANIFOLDS AND THE FUNCTOR K_2

Allen E. Hatcher *

and

John B. Wagoner**

*Supported in part by NSF grant GP-34324X

**Supported in part by NSF grant GP-34217X

Introduction and summary of results.

Let $(M, \partial M)$ be a smooth, compact, C^∞ manifold of dimension n . A pseudo-isotopy of $(M, \partial M)$ is a diffeomorphism $f: (M, \partial M) \times I \rightarrow (M, \partial M) \times I$ such that f restricted to $M \times 0$ is the identity and f restricted to $\partial M \times I$ is an isotopy (i.e. it preserves projection onto I). Let $\mathcal{P} = \mathcal{P}(M, \partial M)$ denote the group of pseudo-isotopies of $(M, \partial M)$ where the multiplication is composition and we give \mathcal{P} the C^∞ topology. The problem is to compute $\pi_0(\mathcal{P})$. See the introduction to [3] and Sections 4 and 5 of [12] for applications of such a computation.

Here are the algebraic K-theory functors we will need:

Following [19] let Λ be any associative ring with unit and define the Steinberg group $St(\Lambda)$ to be the free group generated by symbols $x_{ij}(\lambda)$ where $1 \leq i, j < \infty, i \neq j$, and $\lambda \in \Lambda$, modulo the relations

- (i) $x_{ij}(\lambda) \cdot x_{ij}(\mu) = x_{ij}(\lambda + \mu)$
- (ii) $[x_{ij}(\lambda), x_{k\ell}(\mu)] = 1$ for $i \neq \ell$ and $j \neq k$
- (iii) $[x_{ij}(\lambda), x_{jk}(\mu)] = x_{ik}(\lambda\mu)$ for i, j, k distinct.

Sometimes we write x_{ij}^λ for $x_{ij}(\lambda)$. Let $GL(\Lambda) = \varinjlim_{n \rightarrow \infty} GL_n(\Lambda)$ be the infinite general linear group and $E(\Lambda) \subset GL(\Lambda)$ be the subgroup generated by the elementary matrices e_{ij}^λ , where e_{ij}^λ is the identity on the diagonal, has λ as the $(i, j)^{th}$ entry, and is zero elsewhere.

The correspondence $x_{ij}^\lambda \rightarrow e_{ij}^\lambda$ defines a surjective homomorphism

$$\pi: St(\Lambda) \rightarrow E(\Lambda)$$

and Milnor defines the functor K_2 in [19] as

$$K_2(\Lambda) = \text{kernel of } \pi.$$

The group K_2 is abelian because it is the center of $\text{St}(\Lambda)$. See [19]. Now let $\Lambda = Z[\pi_1 M]$, the integral group ring of $\pi_1 M$. Let $W(\pm\pi_1) \subset \text{St}(\Lambda)$ denote the subgroup generated by words $w_{ij}(\pm g)$ of the form $x_{ij}(\pm g) \cdot x_{ji}(\mp g^{-1}) \cdot x_{ij}(\pm g)$ for $g \in \pi_1 M$. Let $W_0(\pm\pi_1) = K_2(\Lambda) \cap W(\pm\pi_1)$ and define

$$\text{Wh}_2(\pi_1 M) = K_2(Z[\pi_1 M]) \text{ mod } W_0(\pm\pi_1 M)$$

This is the first obstruction group for measuring $\pi_0(\mathcal{P})$.

To define the second part let $(Z_2 \times \pi_2 M)[\pi_1 M]$ denote the group of all functions $f: \pi_1 M \rightarrow Z_2 \times \pi_2 M$ which are zero except on finitely many elements of $\pi_1 M$; that is, $(Z_2 \times \pi_2 M)[\pi_1 M]$ is the direct sum of $|\pi_1 M|$ many copies of $Z_2 \times \pi_2 M$. Any element of $(Z_2 \times \pi_2 M)[\pi_1 M]$ can be written as a finite formal sum $\sum_i \alpha_i \sigma_i$ where $\alpha_i \in Z_2 \times \pi_2 M$ and $\sigma_i \in \pi_1 M$. Let $\pi_1 M$ act trivially on Z_2 and let it act in the usual way on $\pi_2 M$. If $\alpha \in Z_2 \times \pi_2 M$ and $\tau \in \pi_1 M$, denote the action of τ on α as α^τ . Define

$$\text{Wh}_1(\pi_1 M; Z_2 \times \pi_2 M)$$

to be $(Z_2 \times \pi_2 M)[\pi_1 M]$ modulo the subgroup generated by $\alpha \cdot \sigma - \alpha^\tau \cdot \tau \sigma \tau^{-1}$ and $\beta \cdot 1$ for $\alpha, \beta \in Z_2 \times \pi_2 M$ and $\sigma, \tau \in \pi_1 M$. Here 1 denotes the identity of $\pi_1 M$. See [12] for a more conceptual definition of this group.

The main result is

Theorem. For any connected, compact, C^∞ manifold $(M^n, \partial M^n)$ there are homomorphisms

$$\Sigma: \pi_0(\mathcal{P}) \rightarrow Wh_2(\pi_1 M)$$

and

$$\theta: \pi_0(\mathcal{P}) \rightarrow Wh_1(\pi_1 M; Z_2 \times \pi_2 M)$$

such that both are surjective for $n \geq 5$ and whenever $n \geq 7$ (*)

$$\Sigma + \theta: \pi_0(\mathcal{P}) \rightarrow Wh_2(\pi_1 M) \oplus Wh_1(\pi_1 M; Z_2 \times \pi_2 M)$$

is an isomorphism.

The homomorphism Σ was constructed and its kernel identified geometrically by both of the authors working independently. See [11] and [28]. The homomorphism θ was constructed by the first author in [12], which is Part II of this volume. In Part I we shall prove the main theorem except for giving the construction of θ . This theorem has also been announced by I.A. Volodin in [35].

When $\pi_1 M = 0$ the group $Wh_2(\pi_1 M)$ vanishes because $K_2(Z) \approx Z_2$ with the generator being $w_{12}(1)^4$. See [19]. Also $Wh_1(1; Z_2 \times \pi_2 M)$ vanishes as one sees directly from the definition above. Although in the general case $\Sigma + \theta$ is injective for $n \geq 7$, in the simply connected case our methods work when $n \geq 5$ to recover Cerf's theorem [3] that $\pi_0(\mathcal{P}) = 0$.

(*) Note added in proof : In fact $n \geq 6$ is sufficient. See p.VII.11.

Here is some information presently known about $Wh_2(\pi)$.

- (a) If π is finite, then $Wh_2(\pi)$ is probably finite. See [7], [8].
- (b) $Wh_2(Z_{20})$ has at least order 5 (Milnor).
- (c) $Wh_2(\pi \times Z) = Wh_2(\pi) \oplus Wh_1(\pi) \oplus (?)$

Here $Wh_1(\pi)$ is the usual Whitehead group. See [29]. This algebraic result was suggested by geometric examples in [22].

- (d) $Wh_2(\text{free abelian group}) = 0$. This follows from (c) and the fact recently proved by Quillen that for a left regular ring A there are isomorphisms $K_2(A) \cong K_2(A[t])$ and $K_2(A[t, t^{-1}]) \cong K_2(A) \oplus K_1(A)$. Compare [29], [1, Chap. XIII] or [9].
- (e) $Wh_2(\text{free group}) = 0$ (Swan and Gersten using methods of Quillen).

The formula in (c) is related to pseudo-isotopies on $M \times S^1$ where $\pi = \pi_1 M$. Using geometric arguments Wu-chung Hsiang has recently in [32] given a description of $(?)$, showing in particular that $(?)$ is not finitely generated for $\pi = Z_p \times Z^3$ where p is an odd prime. Pseudo-isotopies on a manifold which is the connected sum of X^n and Y^n with $\pi_1 X = A$ and $\pi_1 Y = B$ are related to the computation of $Wh_2(A*B)$. In [24] it was shown that $Wh_1(A*B) = Wh_1(A) \oplus Wh_1(B)$. Is the same true for Wh_2 ? Note that $Wh_1(\pi_1; Z_2 \times \pi_2)$ behaves badly with respect to connected sum. For example, when $\pi_1 X = \pi_1 Y = Z_2$ and $\pi_2 X = \pi_2 Y = 0$ we have $Wh_1(Z_2; Z_2) = Z_2$ while $Wh_1(Z_2 * Z_2; Z_2)$ is not finitely generated.

Beyond this volume there is the problem of computing the higher homotopy groups $\pi_k(\mathcal{P})$ for $k \geq 1$. The techniques used here and those of [13] indicate that these groups will probably

depend more and more on the tangential homotopy type of M as k gets large. Part of $\pi_k(\mathcal{P})$ should however depend only on $\pi_1 M$ and there should be higher algebraic K-theory functors $Wh_{k+2}(\pi_1 M)$ together with surjections $\pi_k(\mathcal{P}) \rightarrow Wh_{k+2}(\pi_1 M)$. Compare [33], [34],[35], and [36]. One problem in studying $\pi_k(\mathcal{P})$ with Cerf's approach [3] of using the stratification of the space of smooth real valued functions on $M \times I$ is that continuous moduli appear in smooth singularities of high codimension. However, Mather's work on singularities shows there are only finitely many singularity types up to piecewise linear equivalence in a given codimension. Thus maybe the piecewise-linear case is easier to handle. Coincidentally Burghlea and Lashof have shown recently that the space $\mathcal{P}_{p.l.}$ of piecewise-linear pseudo-isotopies has the same number of components as the space \mathcal{P}_{diff} of smooth pseudo-isotopies. However, the map $\pi_1 \mathcal{P}_{diff} \rightarrow \pi_1 \mathcal{P}_{p.l.}$ is not an isomorphism (n large). See [35], [36].

Here is how Part I is organized: In Chapter I we explain Cerf's approach to the pseudo-isotopy problem using one parameter families in the space \mathcal{F} of C^∞ functions on $M \times I$ and then introduce the space of gradient-like vector fields. The key concepts are the graphic of a k -parameter family, the stratification of \mathcal{F} , nice gradient-like families of vector fields, i/j intersections of trajectories, general position of a family of gradient-like vector fields, independence of trajectories, suspension, and one and two parameter ordering. See the tables " \mathcal{F}^1 graphics" and " \mathcal{F}^2 graphics" in §2 for a summary of how one and two parameter families of functions behave. Section 8 discusses one and two parameter ordering and shows how to deform one and two parameter families using essentially only general position methods

into families with a graphic that is relatively simple, i.e., ordered. In later parts of the paper we usually just start with ordered families.

Chapter II shows how the geometry of the $i/\subscript{1}$ crossings in certain one-parameter families of gradient-like vector fields gives rise to a word in the Steinberg group. In order to show this word determines a well-defined invariant in $Wh_2(\pi_1 M)$ it is necessary to see what happens as the one-parameter family is deformed. The reader should consult Table 2.3 in §2 of II for a summary of the three basic types of changes in the graphic which must be analyzed. Chapter III develops the algebraic machinery used in proving that the Steinberg word of a one parameter family gives a well-defined element in $Wh_2(\pi_1 M)$. The material is the one-parameter analogue of what is done in defining the Whitehead torsion of an acyclic complex of length greater than two.

Chapter IV completes the definition of the $Wh_2(\pi_1 M)$ invariant of a pseudo-isotopy. The main work is to show why the geometric changes which occur when a one parameter family of gradient-like vector fields is deformed only alter the Steinberg word of that one parameter family by relations defining the Wh_2 group.

Chapter V is mostly geometric. Techniques for simplifying the graphic of a k -parameter family are given and in particular it is shown that for $0 \leq k \leq 2$ any k -parameter family can be reduced to one with critical points having indices only in two consecutive dimensions. This is needed in Part II for the definition of the $Wh_1(\pi_1 M; Z_2 \times \pi_2 M)$ invariant of a pseudo-isotopy. Attention is called to the last section which shows how the definition of the $Wh_2(\pi_1 M)$ invariant is much simpler in the "two index" situation.

Chapter VI and VII give the proof of the main result computing $\pi_0(\mathcal{P})$ except for showing that the second obstruction in $Wh_1(\pi_1 M; \mathbb{Z}_2 \times \pi_2 M)$ is well-defined. This last part is computed in [12], which is Part II of this volume. Chapter VIII gives product and duality formulae for the Wh_2 invariant of a pseudo-isotopy.

In addition to constructing the $Wh_1(\pi_1; \mathbb{Z}_2 \times \pi_2)$ invariant, Part II includes product and duality formulae for the second obstruction.

Finally, the pages in Part I are numbered so that, say, V. 13 means p. 13 of Chapter V.

CHAPTER I. Pseudo-isotopies and real valued functions.

In this chapter we begin by recalling Cerf's reduction of the pseudo-isotopy problem to the study of the space of all C^∞ functions on $M \times I$. Then we discuss a number of results and techniques which form the groundwork for the rest of the paper.

§1. Cerf's "functional approach" to pseudo-isotopies [3].

Let \mathcal{F} be the space of C^∞ functions $f: M \times I \rightarrow I$ such that $f(x,0) = 0$ and $f(x,1) = 1$ for all $x \in M$, f has no critical points near $M \times 0$ and $M \times 1$, and $f(x,t) = t$ for all $x \in \partial M$. Here I denotes the interval $[0,1]$. Let $p: M \times I \rightarrow I$ denote the standard projection. Let $\mathcal{G} \subset \mathcal{F}$ be the subspace consisting of those functions with no critical points. The correspondence $g \rightarrow p \circ g$ induces a fibration

$$\mathcal{J} \rightarrow \mathcal{P} \rightarrow \mathcal{G}$$

$$\pi$$

where the fiber $\mathcal{J} = \pi^{-1}(p)$ is just the space of isotopies of the identity of M (i.e. the space of level preserving diffeomorphisms of $M \times I$ which are the identity on $M \times 0$). To see, for example, that π is onto choose $f \in \mathcal{G}$ and choose a Riemannian metric on M . Give $M \times I$ the product metric. A diffeomorphism g of $M \times I$ to itself with $p \circ g = f$ is obtained by mapping the interval $x \times I$ to the trajectory of $\text{grad } f$ which starts at $x \times 0 \in M \times 0$ and ends somewhere in $M \times 1$. Now the space \mathcal{J} is contractible because it is just the space of all paths from the identity in $\text{Diff}(M, \partial M)$. Hence there is a homotopy equivalence

$$\pi: \mathcal{P} \rightarrow \mathcal{G} .$$

Since \mathcal{F} is contractible we have

$$\pi_1(\mathcal{P}) \simeq \pi_1(\mathcal{G}) \simeq \pi_{i+1}(\mathcal{F}, \mathcal{G}; p).$$

The general plan, then, for measuring the obstruction to connecting any pseudo-isotopy $g \in \mathcal{P}$ to the identity by a path in \mathcal{P} is to join p to $p \circ g$ by a path in \mathcal{F} and then try to deform this path down into \mathcal{E} keeping endpoints fixed.

Since $\pi_0(\mathcal{P})$ is a group the bijection above induces a group structure on $\pi_0(\mathcal{E})$ and $\pi_1(\mathcal{F}, \mathcal{E}; p)$. Here is how to do this directly. Let $f, g \in \mathcal{F}$. Deform f and g by a very small amount (so that if f and g are in \mathcal{E} they remain in \mathcal{E}) until they agree with p on $M \times [0, \epsilon]$ and $M \times [1 - \epsilon, 1]$ for some small $\epsilon > 0$. Then define $f \# g: M \times I \rightarrow I$ by

$$f \# g(x, t) = \begin{cases} \frac{1}{2}f(x, 2t) & , \quad 0 \leq t \leq \frac{1}{2} \\ \frac{1}{2}g(x, 2t-1) + \frac{1}{2} & , \quad \frac{1}{2} \leq t \leq 1 \end{cases}$$

If $[f]$ and $[g]$ are in $\pi_0(\mathcal{E})$ then

$$[f] \cdot [g] = [f \# g].$$

Similarly, if $[f_s]$ and $[g_s]$ are in $\pi_1(\mathcal{F}, \mathcal{E}; p)$ are represented by paths f_s and g_s , $0 \leq s \leq 1$, then

$$[f_s] \cdot [g_s] = [f_s \# g_s].$$

Lemma 1.1. If $\dim M \geq 6$, then $\pi_0(\mathcal{P})$ is abelian.

This lemma will not be needed in the sequel and in fact for $\dim M \geq 7$ it is a consequence of the main theorem.

Proof. Choose an ordered morse function $f: M \rightarrow \mathbb{R}$ (i.e. index $p > \text{index } q \Rightarrow f(p) > f(q)$). Let $3 \leq k \leq \dim M - 3$ be a fixed integer and let $c \in \mathbb{R}$ be a non-critical value of f such that for any critical point p of f , $f(p) < c$ iff index $p \leq k$ and $f(p) > c$ iff index $p > k$. Let $A = f^{-1}((-\infty, c])$ and $B = f^{-1}([c, \infty))$. Both A and B have handle decompositions in which each handle has codimension at least three. Now let F and $G \in \mathcal{P}$. Use the fact that "pseudo-isotopy implies isotopy" in codimension at least three [15] to inductively deform F on the subspaces $(\text{handle of } A) \times I$ until it becomes the identity on $A \times I$ and has support in $B \times I$. See [20]. Similarly deform G so that it is the identity on $B \times I$ and has support in $A \times I$. Then clearly $F \cdot G = G \cdot F$.

Remark. Since the space of paths from the identity in $\text{Diff}(\partial M)$ is contractible the space $\mathcal{P}(M, \partial M)$ defined in the introduction has the same homotopy type as the space of diffeomorphisms of $(M, \partial M) \times I$ which are the identity on $M \times 0$ and $\partial M \times I$. We shall henceforth identify these spaces.

§2. The stratification of \mathcal{F} .

In this section we recall from [3] some facts about the low dimensional strata in the space of all smooth real valued functions on a manifold. We shall describe what a "generic" k -parameter family of maps looks like for $0 \leq k \leq 2$.

Let V^{n+1} be a smooth compact manifold with $\partial V = C \cup D$. Let \mathcal{F} denote the space of all C^∞ functions $f: (V; C, D) \rightarrow (I; 0, 1)$ with no critical points near ∂V . As in [3] we can write \mathcal{F} as the disjoint union

$$\mathcal{F} = \mathcal{F}^0 \cup \mathcal{F}^1 \cup \mathcal{F}^2 \cup \mathcal{F}^3 \cup \mathcal{H}$$

where \mathcal{F}^k consists of those functions of codimension k ($0 \leq k \leq 3$) and \mathcal{H} consists of functions of higher codimension. For $0 \leq k \leq 3$ we can compute the codimension of a function as follows: Let $f \in \mathcal{F}$ and let p be an isolated critical point of f . The codimension of p is the codimension (as a vector space over the real numbers) of the ideal generated by the partial derivatives of f in the ideal of all germs of functions on V vanishing at p . The codimension of a critical value α of f is the number of critical points in $f^{-1}(\alpha)$ minus one. Let

$$v_1(f) = \text{sum of codimensions of critical points}$$

$$v_2(f) = \text{sum of codimensions of critical values.}$$

Then for $0 \leq k \leq 3$

$$\text{codimension of } f = v_1(f) + v_2(f).$$

The canonical forms for critical points of codimension less than or equal to two are

Codim 0 (non degenerate critical point)

$$(0) \quad -x_1^2 - \dots - x_i^2 + x_{i+1}^2 + \dots + x_n^2 + x_{n+1}^2$$

Codim 1 (birth or death point)

$$(1) \quad -x_1^2 - \dots - x_i^2 + x_{i+1}^2 + \dots + x_n^2 + x_{n+1}^3$$

Codim 2 (dovetail point)

$$(2) \quad -x_1^2 - \dots - x_i^2 + x_{i+1}^2 + \dots + x_n^2 \pm x_{n+1}^4 .$$

We shall say for the above models that 0 is a critical point of index i in the cases (0) and (1). In the case (2) we say 0 is a critical point of index i when "+ x_{n+1}^4 " is the last term and of index $i+1$ when "- x_{n+1}^4 " is the last term.

The canonical models for the universal unfoldings of these singularities are respectively

$$(0') \quad -x_1^2 - \dots - x_i^2 + x_{i+1}^2 + \dots + x_{n+1}^2$$

$$(1') \quad -x_1^2 - \dots - x_i^2 + x_{i+1}^2 + \dots + x_n^2 + tx_{n+1} + x_{n+1}^3$$

$$(2') \quad -x_1^2 - \dots - x_i^2 + x_{i+1}^2 + \dots + x_n^2 \pm (tx_{n+1} + sx_{n+1}^2 + x_{n+1}^4) .$$

For $0 \leq k \leq 3$ the subspace $\mathcal{F}^0 \cup \dots \cup \mathcal{F}^k$ is open in \mathcal{F} and for any $f \in \mathcal{F}^k$ the stratification is locally trivial at f . This means that there is a neighborhood of f in \mathcal{F} of the form $\mathbb{R}^k \times W$ where W is a neighborhood of f in \mathcal{F}^k and where there is a stratification of \mathbb{R}^k with 0 as a point stratum such that the stratification induced on $\mathbb{R}^k \times W$ by the \mathcal{F}^i is just the product stratification whose strata are (strata of \mathbb{R}^k) \times W with $0 \times W = W$. It is an interesting open problem to find a good stratification of \mathcal{H} . Recent examples of H. Hendriks (to appear in Comptes Rendus) show that the stratification of \mathcal{H} by codimension is in general not locally trivial above dimension 7.

The following is an explicit description of \mathcal{F}^0 , \mathcal{F}^1 , and \mathcal{F}^2 .

The stratum \mathcal{F}^0 . We must have $v_1(f) = v_2(f) = 0$. Hence \mathcal{F}^0 consists of functions with only non-degenerate critical points and distinct critical values.

The stratum $\mathcal{F}^1 = \mathcal{F}_\alpha^1 \cup \mathcal{F}_\beta^1$.

\mathcal{F}_α^1 : $v_1(f) = 1$ and $v_2(f) = 0$. There is just one birth point, all other critical points are non-degenerate, and the critical values are distinct.

\mathcal{F}_β^1 : $v_1(f) = 0$ and $v_2(f) = 1$. All critical points are non-degenerate and there is exactly one pair of critical points with the same critical value.

The stratum \mathcal{F}^2 . There are six types of function in \mathcal{F}^2 .

\mathcal{F}_α^2 : $v_2(f) = 2$ and $v_1(f) = 0$. There is exactly one dovetail point and all critical values are distinct.

\mathcal{F}_β^2 : $v_2(f) = 2$ and $v_1(f) = 0$. There are exactly two birth points and all critical values are distinct.

\mathcal{F}_γ^2 : $v_1(f) = 1 = v_2(f)$. There is one birth point and one double critical value for two non-degenerate points.

\mathcal{F}_δ^2 : $v_1(f) = 1 = v_2(f)$. A birth point and a non-degenerate point have the same critical value.

\mathcal{F}_ϵ^2 : $v_1(f) = 0$ and $v_2(f) = 2$. Three non-degenerate points have the same critical value.

\mathcal{F}_ζ^2 : $v_1(f) = 0$ and $v_2(f) = 2$. There are two double critical values.

If $f_z: V^{n+1} \rightarrow R$ is a k -parameter family where z varies over a parameter domain $D \subset R^k$ define the graphic of the family f_z to be

$$\bigcup_{z \in D} [\text{critical values of } f_z]$$

The graphic is a subset of $D \times R$.

For example, the graphic of the one parameter family (1') is

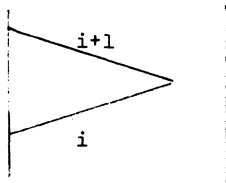

Here the $i+1$ and the i appearing next to the lines in graphic indicate that those lines are the images of critical points of index $i+1$ and i respectively. When $n = 0$ in (1') the actual one parameter family looks like

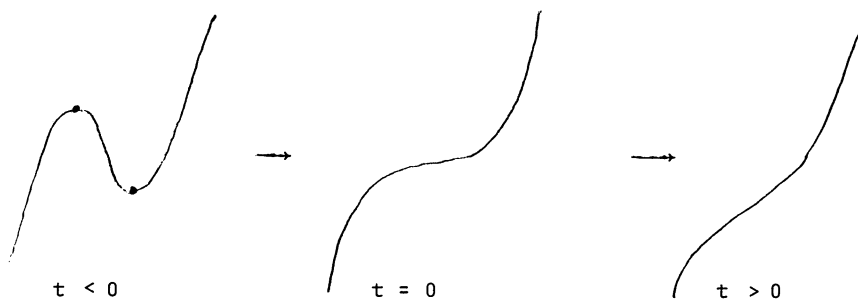

The graphic of the one parameter family



is

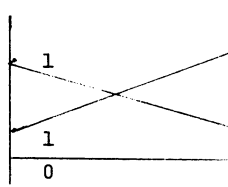

Another typical graphic which might occur for a one parameter family is

PSEUDO-ISOTOPIES AND REAL VALUED FUNCTIONS

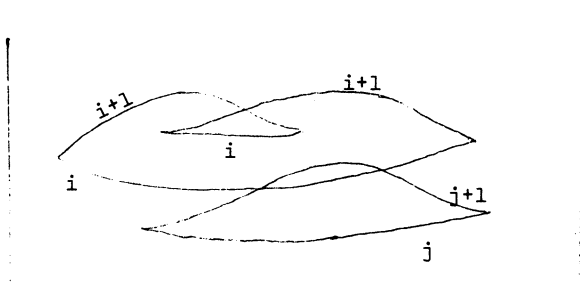

The graphic of the two parameter family $f_{t,s} = -(tx + sx^2 + x^4)$ which is the universal unfolding of x^4 is a subset of $\mathbb{R}^2 \times \mathbb{R}$. The intersections of this graphic with the planes $s = \text{constant}$ are

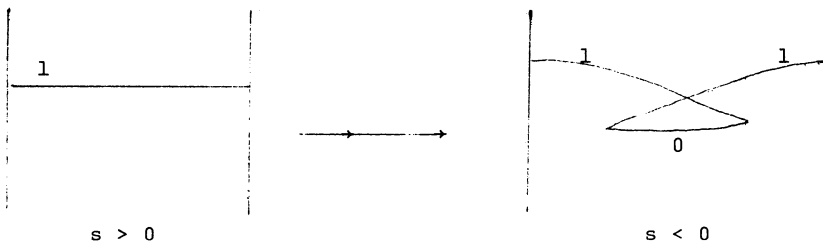

For a fixed $s < 0$ the one parameter family $f_{t,s}$ is

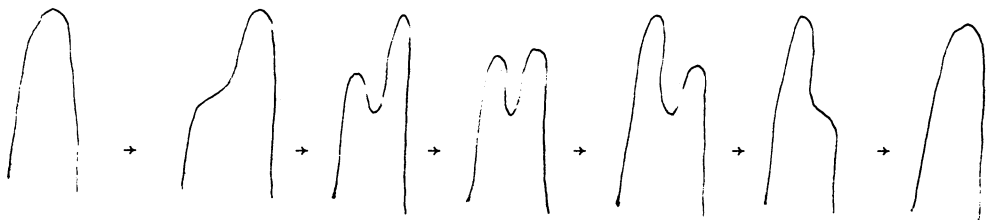

Here is a table of some universal unfoldings of the functions in \mathcal{F}^1 and \mathcal{F}^2 :

\mathcal{F}^1 graphics

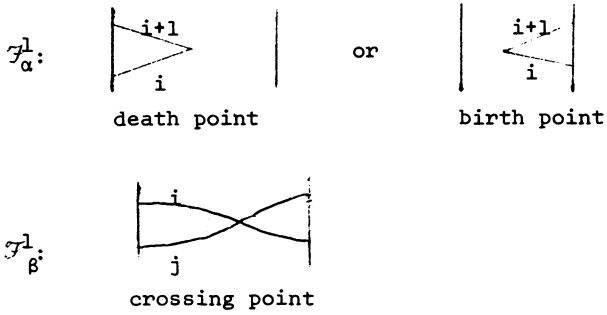

\mathcal{F}^2 graphics

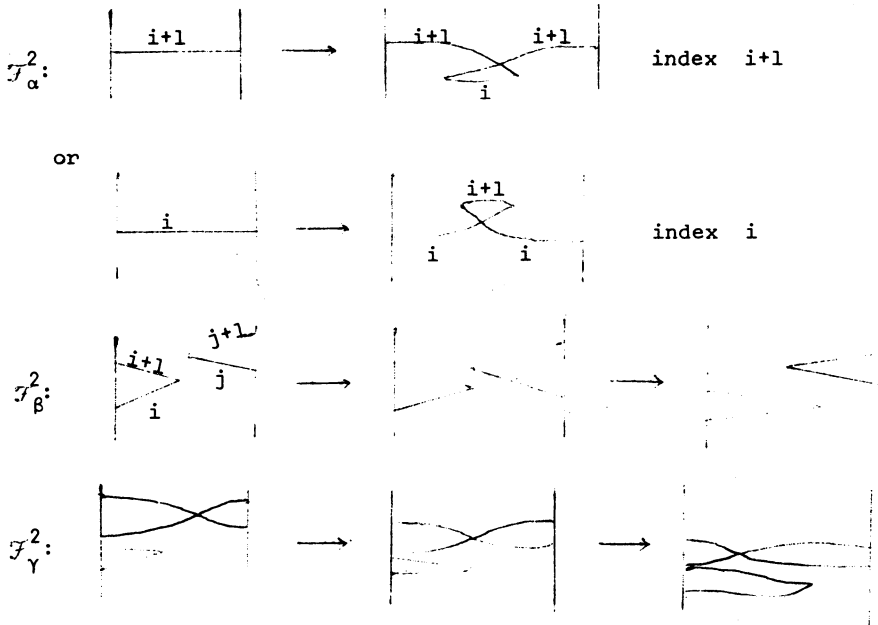

\mathcal{F}^2 graphics

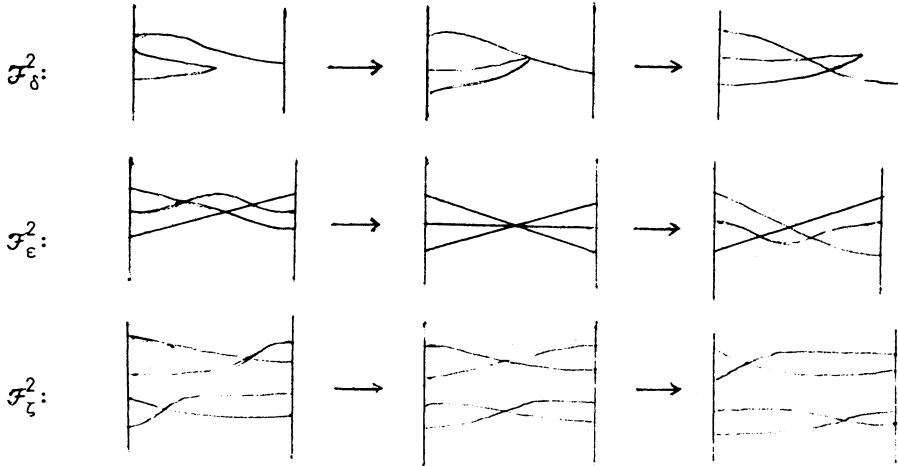

Any k -parameter family $f_z: V^{n+1} \rightarrow R$ where $z \in D^k$ determines a map $F: D^k \times V \rightarrow D^k \times R$ preserving projection onto D^k where $F(z, x) = (z, f_z(x))$. It also determines a map $\alpha: D^k \rightarrow \mathcal{F}$ where $\alpha(z) = f_z$. The following are equivalent statements for $0 \leq k \leq 2$.

- (a) $\alpha(D^k) \subset \mathcal{F}^0 \cup \mathcal{F}^1 \cup \mathcal{F}^2$ and the map α is transverse to each stratum \mathcal{F}^i .
- (b) The map F is "generic". This means first that F has only transverse singularities of type $\Sigma^{n+1,0}, \Sigma^{n+1,1,0}, \Sigma^{n+1,1,1,0}$ (cf. [2]). Furthermore let $\Sigma \subset D^k \times V$ denote the set of all singular points of F . Σ is a smooth k -dimensional submanifold of $D^k \times V$ and $\Sigma = \Sigma_0 \cup \Sigma_1 \cup \Sigma_2$ where

$\Sigma_0 = \Sigma^{n+1,0}(\mathbb{F}) =$ singular points of type $\Sigma^{n+1,0}$, $\Sigma_1 = \Sigma^{n+1,1,0}(\mathbb{F})$, and $\Sigma_2 = \Sigma^{n+1,1,1,0}(\mathbb{F})$. In fact Σ_i consists of those points $(z,p) \in D^k \times V$ such that p is a critical point of f_z of codimension i . $\Sigma_1 \cup \Sigma_2$ is a smooth submanifold of Σ of dimension $k-1$ and Σ_2 is a smooth submanifold of dimension $k-2$. The second condition for genericity of F requires that if Σ_i^α and Σ_j^β are components of Σ_i and Σ_j then the maps $F: \Sigma_i^\alpha \rightarrow D^k \times R$ and $F: \Sigma_j^\beta \rightarrow D^k \times R$ are in general position.

Thom transversality methods show that any k -parameter family can be approximated by a generic family as described above when $0 \leq k \leq 2$. Consequently, any k -parameter family can be deformed off of strata of codimension greater than k and

$$\pi_i(\mathcal{F}, \mathcal{F}^0 \cup \dots \cup \mathcal{W}^k) = 0$$

for $i \leq k \leq 2$.

Let $f_z: V \rightarrow R$ be a generic k -parameter family and let $(u,p) \in \Sigma \subset D^k \times V$. A parametrized version of the splitting theorem of [10], see [31] also, says that there is a neighborhood U of u in D^k and a k -parameter family of imbeddings $\varphi_z: R^{n+1} \rightarrow V$ with $\varphi_u(0) = (u,p)$ such that for some quadratic form $q(x_1, \dots, x_n) = \pm x_1^2 \pm \dots \pm x_n^2$ and some k -parameter family $d_z: R \rightarrow R$ we have

$$(*) \quad f \circ \varphi(x_1, \dots, x_{n+1}) = q(x_1, \dots, x_n) + d_z(x_{n+1})$$

for $z \in U$. If $(z,p) \in \Sigma_i$, then d_z has 0 as a critical point

of codimension i . This says that f_z is essentially a suspension of d_u (see §5 below) and so its behavior is like that of d_z near (u,p) . Canonical models for generic families $d_z: R \rightarrow R$ are

One parameter

$$D(t,x) = (t, \pm x^2), \quad 0 \in \Sigma_0$$

or

$$D(t,x) = (t, tx + x^3), \quad 0 \in \Sigma_1$$

Two parameters

$$D(t,s,x) = (t,s, \pm x^2), \quad 0 \in \Sigma_0$$

or

$$D(t,s,x) = (t,s, sx + x^3), \quad 0 \in \Sigma_1$$

or

$$D(t,s,x) = (t,s, \pm(tx + sx^2 + x^4)), \quad 0 \in \Sigma_2 .$$

A complete description of \mathcal{F}^3 could be given as was done for \mathcal{F}^1 and \mathcal{F}^2 . We content ourselves with listing the codimension three critical points and their universal unfoldings. See [27]. Two of these three kinds of singularities will be used to prove a result in Chapter V §3 (Th. 3.1.b) which, however, is not necessary to our proof of the main theorem. To describe these singularities it suffices by the splitting (*) to give the degenerate part of the function; namely, the d_u 's. The function d_0 is usually called the organizing center.

<u>Name</u>	<u>Organizing Center</u>	<u>Universal Unfolding</u>
Butterfly	x^5	$t_1x + t_2x^3 + t_3x^3 + x^5$
Hyberpolic umbilic	$x^3 + y^3$	$x^3 + y^3 + t_1xy - t_2x - t_3y$
Elliptic umbilic	$x^3 - 3xy^2$	$x^3 - 3xy^2 + t_1(x^2+y^2) - t_2x-t_3y$

The trace of a map $\alpha: D^k \rightarrow \mathcal{F}$ is the decomposition of D^k into the disjoint sets α^{-1} (component of some \mathcal{F}^k). Here are some examples.

The trace of the universal unfolding of the dovetail singularity is

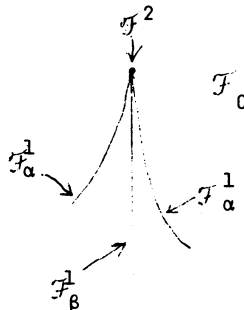

Consider a two parameter family $f_{t,s}: V \rightarrow R$ with a graphic like

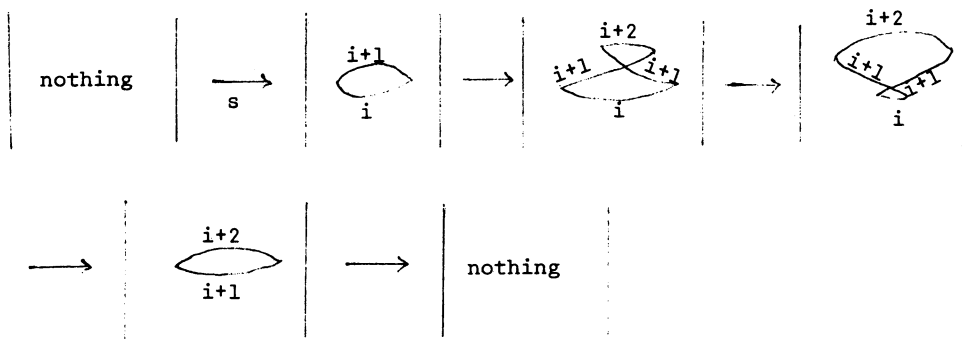

This has trace

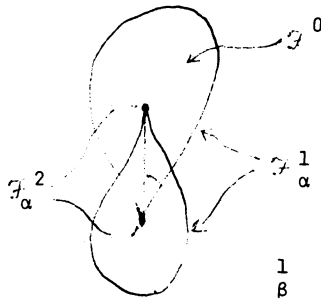

This is a two dimensional section in the trace of the universal unfolding of the hyperbolic umbilic. See [5].

§3. Gradient-like vector fields.

We shall be interested in studying triples (η, f, μ) where $f: V^{n+1} \rightarrow \mathbb{R}$ is a C^∞ function on V as in §2 and η is a vector field on V that is gradient-like for f with respect to the Riemannian metric μ on V . The term gradient-like means that

- (a) $df_x(\eta_x) > 0$ whenever x is not a critical point of f and
- (b) There is a neighborhood U of each critical point p such that $\eta(x) = \text{grad}_\mu f(x)$ for $x \in U$ where the gradient is computed using μ .

Let $\hat{\mathcal{F}}$ denote the space of such triples and, when $V = M \times I$, let $\hat{\mathcal{E}} \subset \hat{\mathcal{F}}$ denote the subspace consisting of those triples (η, f, μ) where f has no critical points. In the case $\partial M \neq \emptyset$ we take $\hat{\mathcal{F}}$ to be all those triples (η, f, μ) such that near $\partial M \times I$ the metric μ is the product metric of some fixed metric on M and the standard metric on I . Now fix a Riemannian metric $\bar{\mu}$ on V . Then the map $\mathcal{F} \rightarrow \hat{\mathcal{F}}$ given by $f \rightarrow (\text{grad}_{\bar{\mu}} f, f, \bar{\mu})$ is a homotopy equivalence which induces a homotopy equivalence of pairs

$$(\mathcal{F}, \mathcal{E}) \xrightarrow{\cong} (\hat{\mathcal{F}}, \hat{\mathcal{E}}).$$

The deformation retraction of $\hat{\mathcal{F}}$ down in \mathcal{F} is done in two stages. First deform (η, f, μ) to $(\text{grad}_\mu f, f, \mu)$ via the path $(t \cdot \text{grad}_\mu f + (1-t)\eta, f, \mu)$, $0 \leq t \leq 1$, and then deform $(\text{grad}_\mu f, f, \mu)$ to $(\text{grad}_{\bar{\mu}} f, f, \bar{\mu})$ by the path $(\text{grad}_{\mu_t} f, f, \mu_t)$ where $\mu_t = t \bar{\mu} + (1-t)\mu$ for $0 \leq t \leq 1$.

We have in particular

$$\pi_1(\mathcal{F}, \mathbb{E}; p) \cong \pi_1(\hat{\mathcal{F}}, \hat{\mathbb{E}}; \hat{p})$$

where $\hat{p} = (\text{grad}_{\hat{\mu}} p, p, \hat{\mu})$.

Now let $(\eta, f, \mu) \in \hat{\mathcal{F}}$ and let $p \in V$ be an isolated critical point of f . Let \mathcal{Q}_t be the one parameter family of diffeomorphisms generated by η . Define the stable and unstable sets of p , written $W(p)$ and $W^*(p)$ respectively, by the equations

$$W(p) = \{x \in V \mid \lim_{t \rightarrow \infty} \mathcal{Q}_t(x) = p\}$$

and

$$W^*(p) = \{x \in V \mid \lim_{t \rightarrow -\infty} \mathcal{Q}_t(x) = p\}$$

Let p and q be two critical points of f of index i and j respectively. Suppose $f(p) > f(q)$ and let $L = f^{-1}(c)$ be an intermediate level surface where $f(p) > c > f(q)$. Then the intersection $W(p) \cap W^*(q) \cap L$ will be called an i/j intersection.

Suppose we have a smooth k -parameter family (η_z, f_z, μ_z) in $\hat{\mathcal{F}}$, $z \in D^k$, such that the map $F: D^k \times V \rightarrow D^k \times R$ is in general position as in §2. For each point (z, p_z) in the critical set Σ , p_z is a critical point of f_z and we have the sets $W(p_z)$ and $W^*(p_z)$ contained as subsets of $z \times V$. We shall need to know how these sets vary as (z, p_z) moves around in Σ because the Wh_2 invariant for pseudo-isotopies comes from the i/i intersections in a one-parameter family in $\hat{\mathcal{F}}$ and the $Wh_1(\pi_1 M; Z_2 \times \pi_2 M)$ invariant comes from the $i+1/i$ intersections in a one parameter family.

In the remainder of this section we will first give six examples of the behavior of the stable and unstable sets near the generic singularities and then give an existence theorem for nice families of gradient like vector fields. To economize in notation we shall often suppress the notation for the Riemannian metric in a k -parameter family and shorten (η_z, f_z, μ_z) to (η_z, f_z) .

Example 1. Each function f_z of the k -parameter family has only isolated, non-degenerate critical points, say of index i . Then $W(p_z) \approx R^i$ and $W^*(p_z) \approx R^{n+1-i}$ and $W(p_z)$ intersects $W^*(p_z)$ transversely in the point p_z . As z moves smoothly in $\Sigma_0 = \Sigma$ the stable and unstable manifolds vary smoothly. This is just "stable manifold theory". See [14].

Example 2. ($k=1$). Consider the one-parameter family $(\text{grad } f_t, f_t, \mu)$ where μ is the standard metric on R^{n+1} and $f_t(x_1, \dots, x_{n+1}) = -x_1^2 - \dots - x_i^2 + x_{i+1}^2 + \dots + x_n^2 + tx_{n+1} + x_{n+1}^3$. When $t = 0$ there is just one critical point, namely 0, which lies in Σ_1 . When $t < 0$, f_t has two non-degenerate critical points $a_t = (0, \dots, 0, \sqrt{-t/3})$ and $b_t = (0, \dots, 0, -\sqrt{-t/3})$ of index i and $i+1$ respectively. Both a_t and b_t are in Σ_0 . For $t > 0$ f_t has no critical points at all. Then for $t < 0$ we have (in $R^i \times R^{n-i} \times R$)

$$\begin{aligned} W(a_t) &= R^i \times 0 \times \{c_t\}, & c_t &= \sqrt{-t/3} \\ W^*(a_t) &= 0 \times R^{n-i} \times \{-c_t < x_{n+1}\} \\ W(b_t) &= R^i \times 0 \times \{x_{n+1} < c_t\} \\ W^*(b_t) &= 0 \times R^{n-i} \times \{c_t\} \end{aligned}$$

For $t = 0$ we have

$$W(0) = \mathbb{R}^i \times 0 \times \{x_{n+1} \leq 0\} \text{ and } W^*(0) = 0 \times \mathbb{R}^{n-i} \times \{0 \leq x_{n+1}\}.$$

In particular $W(0)$ and $W^*(0)$ are half spaces.

Let $\epsilon > 0$ and choose $d > 0$ so that for $t \in [-\epsilon, \epsilon]$ the critical values of f_t are contained in $(-d, d)$. The corresponding graphic is

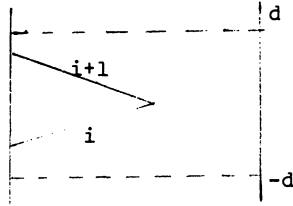

For $t < 0$, let $X_t = f_t^{-1}([-d, d]) \cap (W(a_t) \cup W^*(a_t) \cup W(b_t) \cup W^*(b_t))$.

Let $X_0 = f_0^{-1}([-d, d]) \cap (W(0) \cup W^*(0))$. For $t \leq 0$, let

$X_t(\pm d) = f_t^{-1}(\pm d) \cap X_t$. Then for $t \leq 0$ we have

- (a) X_t is contractible
- (b) $X_t(d)$ is an $(n-i)$ disc with boundary the $(n-i-1)$ sphere $W^*(b_t) \cap f_t^{-1}(d)$
- (c) $X_t(-d)$ is an i -disc with boundary the $(i-1)$ sphere $W(a_t) \cap f_t^{-1}(-d)$.

For $t < 0$ we also have

- (d) the i -sphere $W(b_t) \cap f_t^{-1}(0)$ and the $(n-i)$ -sphere $W^*(a_t) \cap f_t^{-1}(0)$ intersect each other transversely in a single point in the level surface $f_t^{-1}(0)$.

Example 3. Consider the two parameter family $(\eta_{t,s}, f_{t,s})$ where

$$f_{t,s} = -x_1^2 - \dots - x_i^2 + x_{i+1}^2 + \dots + x_n^2 + (tx_{n+1} + x_{n+1}^3)$$

and $\eta_{t,s}$ is the gradient of $f_{t,s}$ with respect to the standard metric. This is just a one-parameter version of the previous example. In each slice $s = \text{constant}$ the behavior of the stable and unstable manifolds is as in Example 2.

Example 4. (Dovetail singularity). Let $(\eta_{t,s}, f_{t,s})$ be the two parameter family where

$$f_{t,s}(x_1, \dots, x_{n+1}) = -x_1^2 - \dots - x_i^2 + x_{i+1}^2 + \dots + x_n^2 - (tx_{n+1} + sx_{n+1}^2 + x_{n+1}^4)$$

and $\eta_{t,s}$ is the gradient of $f_{t,s}$ with respect to the standard metric of \mathbb{R}^{n+1} . As s goes from positive to negative the change in the graphic is

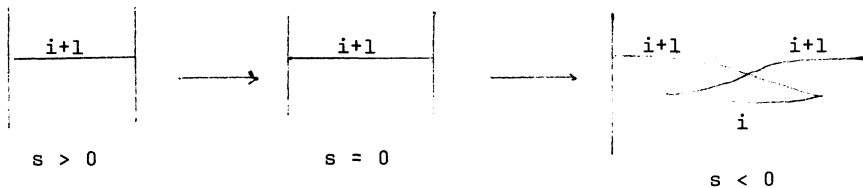

For $s > 0$ there is just one non-degenerate critical point of index $i+1$ at each time t ; for $s = 0$ there is a non-degenerate critical point when $t \neq 0$ and a codimension two critical point, namely 0 , when $t = 0$. For $t = s = 0$, we have (in $\mathbb{R}^i \times \mathbb{R}^{n-i} \times \mathbb{R}$) $W(0) = \mathbb{R}^i \times 0 \times \mathbb{R}$ and $W^*(0) = 0 \times \mathbb{R}^{n-i} \times 0$.

Fix $s < 0$ and for all t set $(\eta_t, f_t) = (\eta_{t,s}, f_{t,s})$. Let a_t for $t < \delta$ and b_t for $-\delta < t$ denote the critical points of index $i+1$ as indicated in the diagram below. For $-\delta < t < \delta$ let c_t denote the critical point of index i . Let $c_{-\delta}$ and c_δ be the birth and death critical points respectively.

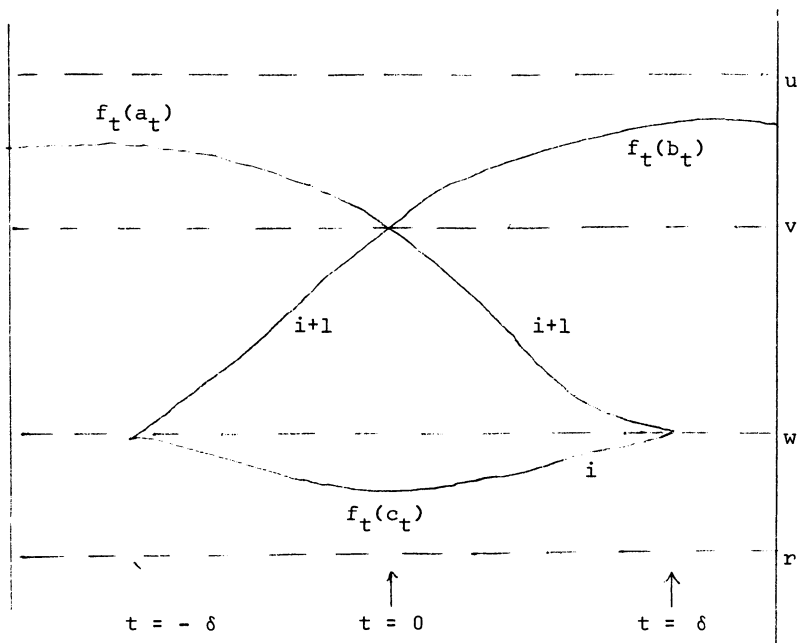

Here is how the stable and unstable sets vary within the intermediate level surfaces. See [3;IV.14] and particularly [5, Chap. 2].

- (1) Near the birth and death points the situation is just as in Example 2 above.
- (2) In the u -level $K_t = f_t^{-1}(u)$:

$$W^*(a_t) \cap K_t \cong S^{n-i-1}(a_t)$$

$$W^*(b_t) \cap K_t \cong S^{n-i-1}(b_t)$$

closure of

$$W^*(c_t) \cap K_t \cong S^{n-i-1} \times I$$

$$\text{where } \begin{aligned} S^{n-i-1} \times 0 &\cong S^{n-i-1}(a_t) \\ S^{n-i-1} \times 1 &\cong S^{n-i-1}(b_t) \end{aligned}$$

See the following diagram:

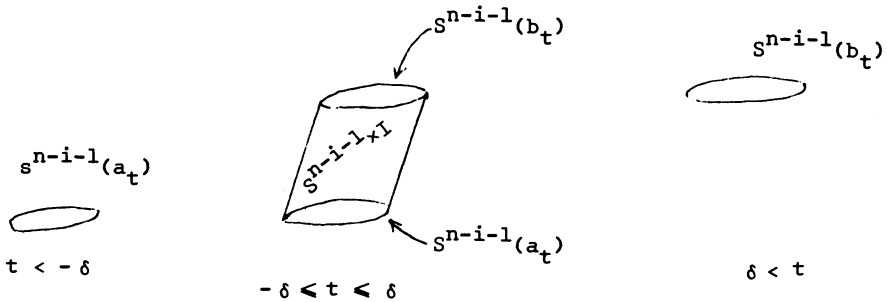

Another diagram illustrating the variation is

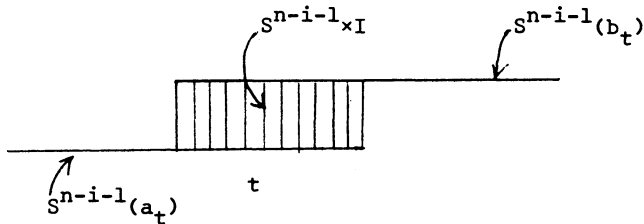

(3) In the v -level surface $L_t = f_t^{-1}(v)$:

For $t < 0$

$$\begin{aligned} W(a_t) \cap L_t &\cong S^i(a_t) \\ W^*(c_{-\delta}) \cap L_{-\delta} &\cong D^{n-i}(c_{-\delta}) \\ W^*(c_t) \cap L_t &\cong \overset{\circ}{D}^{n-i}(c_t) && \text{for } -\delta < t < 0 \\ W^*(b_t) \cap L_t &\cong \partial(W^*(c_t) \cap L_t) \cong S^{n-i-1}(b_t) && \text{for } -\delta < t < 0 \end{aligned}$$

For $t > 0$

$$\begin{aligned} W(b_t) \cap L_t &\cong S^i(b_t) \\ W^*(c_\delta) \cap L_\delta &\cong D^{n-i}(c_\delta) \\ W^*(c_t) \cap L_t &\cong \overset{\circ}{D}^{n-i}(c_t) && \text{for } 0 < t < \delta \\ W^*(a_t) \cap L_t &\cong \partial(W^*(c_t) \cap L_t) \cong S^{n-i-1}(a_t) && \text{for } 0 < t < \delta \end{aligned}$$

Note that for $-\delta \leq t < 0$, $S^i(a_t)$ intersects $\overset{\circ}{D}^{n-i}(c_t)$ transversely in exactly one point; similarly for $0 < t \leq \delta$, $S^i(b_t)$ intersects $\overset{\circ}{D}^{n-i}(c_t)$ transversely in one point. See the following diagram:

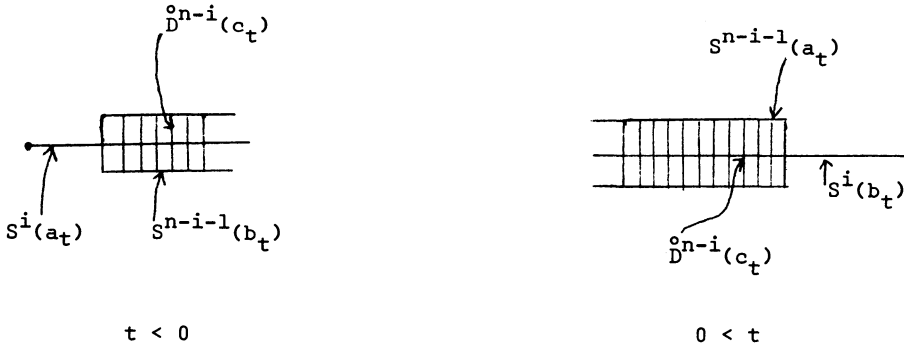

- (4) In the w -level $P_t = f_t^{-1}(w)$: For $-\delta < t < \delta$
 $W(a_t) \cap W^*(b_t) = \phi$ and $W^*(a_t) \cap W(b_t) = \phi$. Hence

$$\begin{aligned} W(a_t) \cap P_t &\cong S^i(a_t) \\ W(b_t) \cap P_t &\cong S^i(b_t) \\ W^*(c_t) \cap P_t &\cong S^{n-i}(c_t) \end{aligned}$$

In fact each of $S^i(a_t)$ and $S^i(b_t)$ intersect $S^{n-i}(c_t)$ transversely in a single point in P_t .

- (5) In the r -level $Q_t = f_t^{-1}(r)$:

$$\begin{aligned} W(a_t) \cap Q_t &\cong S^i(a_t) && (t < -\delta) \\ W(a_t) \cap Q_t &\cong \overset{\circ}{D}^i(a_t) && (-\delta \leq t < \delta) \\ W(b_t) \cap Q_t &\cong \overset{\circ}{D}^i(b_t) && (-\delta < t \leq \delta) \\ W(c_t) \cap Q_t &\cong S^{i-1}(c_t) = \partial \overset{\circ}{D}^i(a_t) = \partial \overset{\circ}{D}^i(b_t) && (-\delta < t < \delta) \\ W(c_{-\delta}) \cap Q_t &\cong D^i(c_{-\delta}) \\ W(c_{\delta}) \cap Q_t &\cong D^i(c_{\delta}) \\ W(b_t) \cap Q_t &\cong S^i(b_t) && (\delta < t) \end{aligned}$$

See the following diagram:

PSEUDO-ISOTOPIES AND REAL VALUED FUNCTIONS

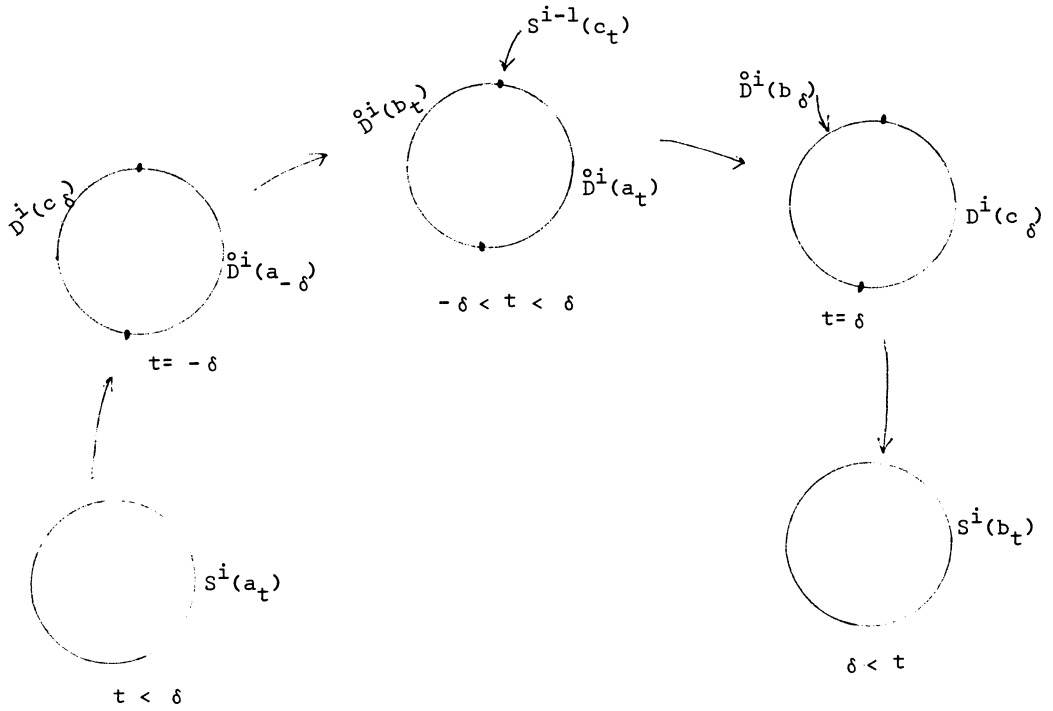

Example 5. ($0 \leq k \leq 2$). Let $F: D^k \times R \rightarrow D^k \times R$ be a generic map where $F(z, x) = (z, f_z(x))$ and let $\mu_z, z \in D^k$, be a smooth family of metrics on R . Let $\eta_z = \text{grad}_{\mu_z} f_z$. Since we are dealing here with gradients of functions of a single real variable the situation is easy to analyze and one sees that the stable and unstable sets of points in Σ have the same intersection phenomena as in the above examples where the standard metric was used.

Example 6. Suppose $f_z: R^{n+1} \rightarrow R$ is a generic k -parameter family, $z \in D^k$, of the form

$$f_z(x_1, \dots, x_{n+1}) = q(x_1, \dots, x_n) + d_z(x_{n+1})$$

where q is a non-degenerate quadratic form in the variables x_1, \dots, x_n and $d_z: R \rightarrow R$ is a generic k -parameter family as in Example 5. Suppose μ_z and μ'_z are smooth k -parameter families of metrics on R^n and on R respectively and let R^{n+1} be given the direct sum metric. Let η_z be the corresponding gradient of f_z . As in Example 5 it is easy to analyze the behavior of d_z : the suspension principle in §5 below shows that the intersections of the stable and unstable manifolds of the critical points of the f_z are the same as those for the critical points of the d_z .

"Nice" families of gradient-like vector fields.

Theorem 3.1. Given a generic k -parameter family $f_z: V^{n+1} \rightarrow R$, $z \in D^k$ and $0 \leq k \leq 2$, it is possible to choose a k -parameter

family of metrics μ_z and a k -parameter family η_z of vector fields, gradient-like for f_z with respect to μ_z , so that the family (η_z, f_z) has the following properties:

- (A) For $(z, p_z) \in \Sigma_0$ and index $p_z = i$, the stable and unstable sets $W(p_z)$ and $W^*(p_z)$ in $z \times V$ are Euclidean spaces of dimension i and $n+1-i$ which vary smoothly as (z, p_z) varies smoothly in Σ_0 .
- (B) For $(z, p_z) \in \Sigma_1$, $W(p_z)$ and $W^*(p_z)$ are smoothly varying half spaces (see Eg. 2). Furthermore, let $\pi(\Sigma_1) \subset D^k$ be the image of Σ_1 under the projection $\pi: D^k \times V \rightarrow D^k$ and suppose $\gamma \subset D^k$ is a small arc cutting $\pi(\Sigma_1)$ transversely in one point as in the diagram

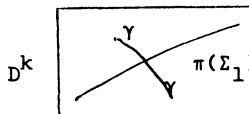

Then the one parameter family f_t , where t runs along γ , locally has a graphic like

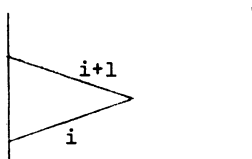

Let b_t be the critical point of index $i+1$ of f_t and a_t be the critical point of index i of f_t near the point p_z . Then in any intermediate level surface L_t between $f_t^{-1}(f_t(b_t))$ and $f_t^{-1}(f_t(a_t))$. The spheres $S_t^i \approx W(b_t) \cap L_t$ and $S_r^{n-i} \approx W^*(a_t) \cap L_t$ intersect each other transversely in one point (as in Example 2).

- (C) For $(z, p_z) \in \Sigma_2$, $W(p_z)$ and $W^*(p_z)$ are Euclidean spaces of complementary dimension intersecting transversely in p_z . The stable and unstable manifolds of the critical points near (z, p_z) vary as in Example 4 above.

Any k -parameter family (η_z, f_z) satisfying (A), (B), and (C) will be called nice.

This definition of nice gradient-like families is more or less ad hoc. One would like to be able to prove (A), (B), and (C) under reasonable hypothesis instead of having to construct a family η_z for which (A), (B), (C) holds. In any case this definition suffices for the present paper. Actually in Chapter V we will need to consider deformations of two parameter families (i.e. three parameter families). However, all the deformations performed will take nice families to nice families.

One way of constructing the η_z and μ_z satisfying (A) through (C) is to first choose local coordinates for the f_z as in (*) of §2 near the points of Σ . The gradient with respect to these local coordinates is easy to analyze as in Examples (1) through (6) and satisfies (A) through (C). The various choices of local coordinates can be made in such a way that they overlap nicely.

Then the local metrics can be patched together by a partition of unity to get a global family of metrics μ_z such that $\eta_z = \text{grad } f_z$ with respect to μ_z satisfies (A), (B), and (C). See [11] and [5] for example. The proof below uses the methods of the splitting theorem in [10].

Proof of (3.1). For $k = 0$, f is a function with non-degenerate critical points. We can choose μ to be any metric on V^{n+1} because the stable and unstable manifolds satisfy (A) by stable manifold theory [14]. We shall do the case $k = 2$ and leave the easier case $k = 1$ to the reader.

Start with the generic two parameter family f_z , $z \in D^2$, as in §2 with singular set $\Sigma = \Sigma_0 \cup \Sigma_1 \cup \Sigma_2$. Let $\Gamma = \Sigma_1 \cup \Sigma_2$ and let $\Lambda \subset D^2$ be the part of the trace which is the image of Γ under the projection $\pi: D^2 \times V^{n+1} \rightarrow D^2$. The parameters $z \in \Lambda$ for which f_z has a dovetail (resp. birth or death) singularity will be called dovetail (resp. birth-death) parameters. The set Λ is stratified as follows. The (isolated) 0-dimensional strata are the dovetail parameters (i.e. $f_z \in \mathcal{F}_\alpha^2$) and the double birth-death parameters (i.e. $f_z \in \mathcal{F}_\beta^2$). Each 1-dimensional strata consists of parameters z where f_z has exactly one birth or death critical point and is either the interior of an arc joining two 0-dimensional strata or is a circle. It will be convenient to introduce two more 0-dimensional strata on each such circle by choosing a pair of points on each. Give Γ the stratification induced by the map $\pi: \Gamma \rightarrow \Lambda$.

Now let u a point stratum of Λ and $p_u \in V^{n+1}$ be a dovetail or birth-death critical point for f_u . The splitting theorem methods of [10] show there is a small ball Δ centered at u together with a family of embeddings $\varphi_z: R^{n+1} \rightarrow V^{n+1}$ and a family of functions $d_z: R \rightarrow R$, where $z \in \Delta$, such that

- (i) if p_u is a dovetail point, $\varphi_u(0) = p_u$;
- (ii) if p_u is a birth-death point, then there is an arc $\gamma \subset \Delta$ of birth-death parameters with end points in $\partial\Delta$ and there is an arc $\bar{\gamma} \subset \Sigma_1$ which maps homeomorphically onto γ by π such that $\varphi_z(0) = p_z \in \bar{\gamma}$ where $\pi(p_z) = z$;
- (iii) $f_z \circ \varphi_z(x_1, \dots, x_n, x_{n+1}) = -x_1^2 - \dots - x_i^2 + x_{i+1}^2 + \dots + x_n^2 + d_z(x_{n+1})$ and the family $d_z: R \rightarrow R$ has the same type of generic singularity as the family f_z .

Give each slice $\varphi_z(R^{n+1}) \subset z \times V^{n+1}$ the metric μ_z induced from the standard metric on R^{n+1} by the embedding φ_z . Then the stable and unstable manifolds of $\text{grad}_{\mu_z}(f_z)$ satisfy (B) if p_u is a birth-death point and satisfy (C) if p_u is a dovetail critical point.

Do this for each of the point strata u_1, \dots, u_m in Λ . This gives a family of embeddings of R^{n+1} over the parameter domain $\Delta_1 \cup \Delta_2 \cup \dots \cup \Delta_m$ where Δ_i is a small ball centered at u_i . The closure Λ' of $\Lambda - (\Delta_1 \cup \dots \cup \Delta_m)$ is the union of finitely many arcs α_j whose end points lie in the boundary of $\Delta_1 \cup \dots \cup \Delta_m$.

Let $\Gamma' = \pi^{-1}(\Lambda') \cap \Sigma_1$. The map $\pi: \Gamma' \rightarrow \Lambda'$ is a homeomorphism. Let $\bar{\alpha}_j$ be the arc which maps to α_j under π . We must extend the metrics already constructed to metrics on the local

slices near each of the arcs $\bar{\alpha}_j$. Let α be one of the arcs α_j as in the following diagram:

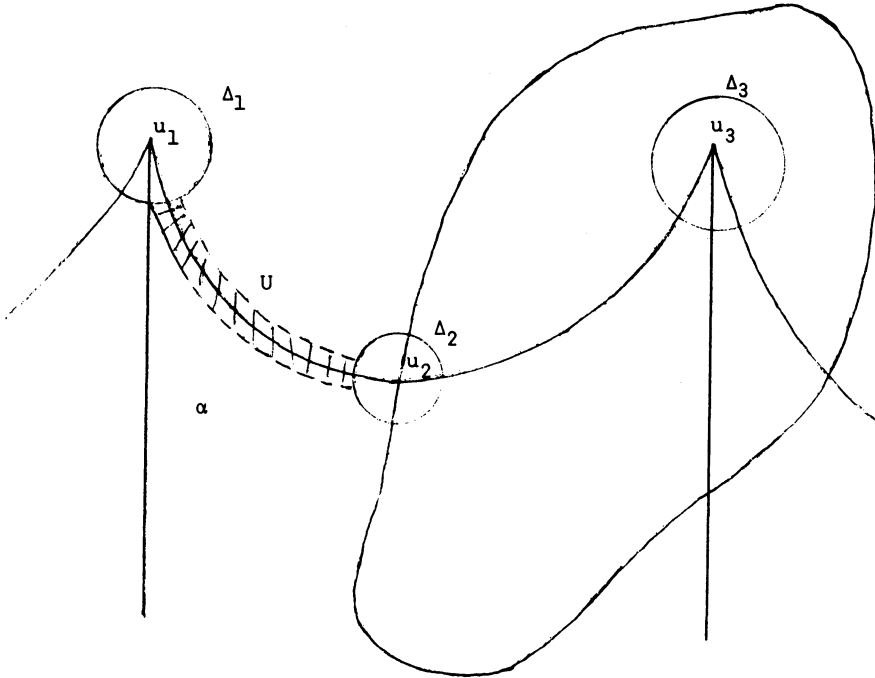

Let $\bar{\alpha}$ denote the corresponding arc $\bar{\alpha}_j$ in Σ_1 . Let $e_1 = \alpha \cap \Delta_1$ and $e_2 = \alpha \cap \Delta_2$ be the endpoints of α and let \bar{e}_1 and \bar{e}_2 denote the corresponding endpoints of $\bar{\alpha}$. More generally for $z \in \alpha$ let $\bar{z} \in \bar{\alpha}$ denote the unique point such that $\pi(\bar{z}) = z$. Let $U \cong J \times \alpha$ be a small neighborhood of α such that $U \cap \Delta_1 = J \times e_1$ and $U \cap \Delta_2 = J \times e_2$ where J is a small interval. The embeddings $\zeta_2: \mathbb{R}^{n+1} \rightarrow \mathbb{V}^{n+1}$, $z \in \Delta_1 \cup \dots \cup \Delta_m$, constructed above give embeddings $\zeta_z: \mathbb{R}^{n+1} \rightarrow \mathbb{V}^{n+1}$ where z runs through $J \times e_1$ and $J \times e_2$. By a translation of the variable x_{n+1} in \mathbb{R}^{n+1} change the families

ζ_z and d_z for $z \in J \times e_1 \cup J \times e_2$ so that $\zeta_{0 \times e_1}(0) = \bar{e}_1$ and so that (iii) holds. Since translation preserves the metric on R^{n+1} , the metrics induced on the images $\zeta_z(R^{n+1})$; $z \in J \times e_1 \cup J \times e_2$, by the new embeddings remains the same. Using the techniques of the splitting theorem [10] extend these embeddings to a family $\zeta_z: R^{n+1} \rightarrow V^{n+1}$ where z runs through U (made smaller perhaps) and extend the family $d_z: R \rightarrow R$, to one defined for $z \in U$ such that

- (i') $\zeta_z(0) = \bar{z}$ for $z \in \alpha$
- (ii') $f_z \circ \zeta_z(x_1, \dots, x_n, x_{n+1}) = -x_1^2 - \dots - x_i^2 + x_{i+1}^2 + \dots + x_n^2 + d_z(x_{n+1})$
for $z \in U$.

Caution. To obtain this extension it may be necessary to match up orientations by changing the embeddings ζ_z , $z \in J \times e_1$, by reflection in one of the axes x_i , $1 \leq i \leq n$, however, the induced metrics μ_z , $z \in J \times e_1$, remain unchanged.

As before let μ_z for $z \in U$ be the metric on $\zeta_z(R^{n+1})$ induced from the standard metric on R^{n+1} by the embedding ζ_z . Then the vector fields $\text{grad}_{\mu_z}(f_z)$ satisfy (B) for z near α .

For any pair $(u, p) \in D^2 \times V^{n+1}$ with $z \notin \Lambda$ or $p \notin \Gamma$ choose a two parameter family of embeddings $\zeta_z: R^{n+1} \rightarrow V^{n+1}$ where $\zeta_u(0) = p$ and z runs through a small neighborhood around u . Let μ_z denote the metric induced on $\zeta_z(R^{n+1})$ by ζ_z from the standard metric on R^{n+1} .

Finally, piece these local metrics together with a partition of unity to get a two parameter family μ_z , $z \in D^2$, of metrics on V^{n+1} and set $\eta_z = \text{grad}_{\mu_z}(f_z)$. As noted above the stable and

unstable sets of critical points near $\Sigma_1 \cup \Sigma_2$ satisfy (B) and (C). The stable and unstable manifolds of the (non-degenerate) critical points in Σ_0 satisfy (A) by stable manifold theory [14].

Remark 3.2. Relative version of (3.1).

If a nice family (η_z, f_z, μ_z) on V^{n+1} has been constructed as above for z running through a neighborhood of a closed set in D^2 , then the family can be extended to all parameter values in D^2 by the construction. In particular, suppose (η'_t, f'_t, μ'_t) and $(\eta''_t, f''_t, \mu''_t)$ are two one-parameter families constructed as above such that $(\eta'_t, f'_t, \mu'_t) = (\eta''_t, f''_t, \mu''_t)$ for $t = 0, 1$. Then there is a nice two parameter family (γ_z, h_z, v_z) which restricts to (η'_t, f'_t, μ'_t) for $z = (t, 0)$ and to $(\eta''_t, f''_t, \mu''_t)$ for $z = (t, 1)$.

There is the general problem of relating the higher homotopy groups $\pi_i(\mathcal{F}, \mathbb{R}; p)$ to higher algebraic K-theory functors Wh_{i+1} and this requires studying k -parameter families (η_z, f_z) for k large. The difficulty is to know how the stable and unstable sets vary with the parameter z . For example, in attempting to prove that nice gradient-like families of vector fields exist one is tempted to fix a metric on V and take $\eta_z = \text{grad } f_z$ for all $z \in D^k$. But consider the one parameter family f_t as in Example 2. and let μ be an arbitrary Riemannian metric on \mathbb{R}^{n+1} . If $\eta_t = \text{grad}_\mu f_t$ is (d) of Example 2 still satisfied? Another typical problem is that for a given function the topological type of the stable set of an isolated critical point may vary as the metric changes. See [26]. Perhaps the machinery of gradient-

like vector fields can be replaced by something easier to handle but which also enjoys the same global aspects. In any case one should look at the homology of a singularity p of a function f , written $H_*(f,p)$, as defined in [10] and [21]. If η is the gradient of f with respect to a metric so that $W(p)$ and $W^*(p)$ are reasonable (say, stratified sets) then

$$H_*(f,p) = H_*(W_{-\epsilon}, \partial W_{-\epsilon})$$

where $W_{-\epsilon} = W(p) \cap f^{-1}([f(p) - \epsilon, f(p) + \epsilon])$ and $\partial W_{-\epsilon} = W(p) \cap f^{-1}(f(p) - \epsilon)$ for a small enough $\epsilon > 0$. What can be said about $H_*(f,p)$? If $H_*(f,p) = 0$ can f be approximated in the C^∞ topology by a function with no critical points?

§ 4. General position of nice gradient-like families.

Let η be a nice gradient like vector field for a function f which has only non-degenerate critical points. We say (η, f) is in general position provided that for any two critical points p and q of f the intersection $W^*(p) \cap W(q)$ is transverse. In [23] it was shown that any nice gradient like vector field for f can be deformed into general position. Here is the basic idea of the proof: suppose p and q are critical points of f with $f(p) < f(q)$ and let L be an intermediate level surface between p and q . By an isotopy of L make the spheres $W^*(p) \cap L$ and $W^*(q) \cap L$ transverse. This isotopy can then be used as in [18, Th. 4.4] to deform η just in a neighborhood of L so that $W^*(p)$ and $W(q)$ become transverse. This type of argument (i.e. deforming η by isotopies of intermediate level surfaces) can be used to obtain a k -parameter version of general position.

Let (η_z, f_z) be a nice k -parameter family, $z \in D^k$, such that $F: D^k \times V \rightarrow D^k \times R$ is generic as in §2. For each component S of a stratum of the singular set Σ of F let

$$W(S) = \bigcup_{(z, p_z) \in S} W(p_z)$$

and

$$W^*(S) = \bigcup_{(z, p_z) \in S} W^*(p_z)$$

Then $W(S)$ and $W^*(S)$ are smooth fiber spaces embedded (not as closed subspaces) in $D^k \times V$ with fiber either a Euclidean space

or a half space. Define the index of S to be the common index (as defined at the beginning of §2) of the critical points in S .

A nice k -parameter family (η_z, f_z) is in general position provided that $W(S_1)$ and $W^*(S_2)$ are in general position in $D^k \times V$ for any two components S_1 and S_2 of strata in the singular set. The following is most likely a theorem:

Probable Theorem 4.1. Any nice k -parameter family (η_z, f_z) , $0 \leq k \leq 2$, can be deformed into general position. If (η_z, f_z) is already in general position when z is restricted to a neighborhood of a closed set $C \subset D^k$, then (η_z, f_z) can be kept fixed for $z \in C$.

This theorem will not be needed in full generality. The following example indicates the transversality method used in proving such a result and without always giving full details we will use this transversality technique in the remainder of the paper to put certain k -parameter families in "partial" general position (i.e. it will only be necessary for $W(S_1)$ and $W^*(S_2)$ to be transverse for certain pairs of components S_1 and S_2).

Suppose the one parameter family (η_t, f_t) has a graphic like

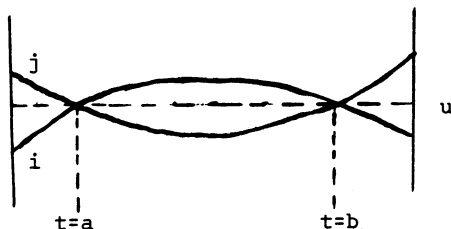

Let p_t denote the critical point of f_t of index i and let q_t denote the critical point of f_t of index j as indicated in the graphic. At the two crossings (i.e. when $f_t \in \mathcal{G}_\beta^1$) certainly $W(p_t) \cap W^*(q_t) = 0$ and hence this also holds for all t satisfying $|t - a| < \epsilon$ and $|t - b| < \epsilon$ for a small enough $\epsilon > 0$. Let $L_t = f_t^{-1}(u)$. The one parameter families $S^{i-1}(p_t) = W(p_t) \cap L_t$ and $S^{n+1-j}(q_t) = W(q_t) \cap L_t$ ($a + \epsilon \leq t \leq b - \epsilon$) form isotopies $S^{i-1} \times J \rightarrow L_{a+\epsilon} \times J$ and $S^{n+1-j} \times J \rightarrow L_{a+\epsilon} \times J$. Deform these maps into general position by approximations. Then use the techniques of [18, Th.4.4] to deform the one parameter family (η_t, f_t) , $a - \epsilon \leq t \leq b + \epsilon$, into general position keeping (η_t, f_t) fixed for $t = a - \epsilon$ and $t = b + \epsilon$.

§5. Suspension.

In this section we describe suspension maps from the spaces $\mathcal{P}, \mathcal{E}, \mathcal{F}, \hat{\mathcal{E}},$ and $\hat{\mathcal{F}}$ for the manifold $(M, \partial M)$ to the corresponding spaces for the manifold $(M \times J, \partial(M \times J))$. Here $J = [-1, 1]$. These maps will be natural up to homotopy for the sequence

$$\mathcal{P} \rightarrow \mathcal{E} \rightarrow \mathcal{F}$$

and the homotopy equivalence

$$(\hat{\mathcal{F}}, \hat{\mathcal{E}}) \rightarrow (\mathcal{F}, \mathcal{E})$$

On elements of $\hat{\mathcal{F}}$ suspension has the property that no new critical points are introduced and the intersections of the stable and unstable manifolds are preserved. The basic idea of the construction is illustrated in the following diagram:

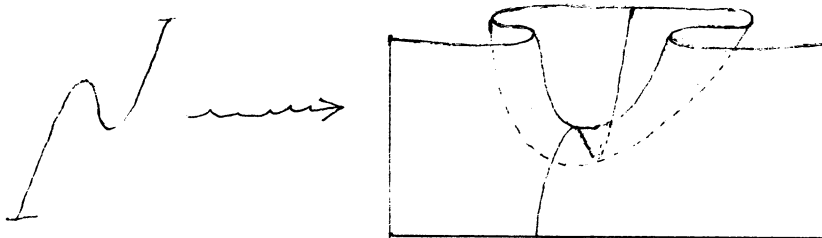

For convenience in defining the suspension we replace $\mathcal{O}(M, \partial M)$ by $\mathcal{O}'(M, \partial M)$, the subspace of diffeomorphisms of $M \times I$ which are the identity on $M \times [0, \epsilon] \cup \partial M \times I$ and which are of the form $(x, t) \rightarrow (f(x), t)$ for $1 - \epsilon \leq t \leq 1$; $\mathcal{F}(M, \partial M)$ by $\mathcal{F}'(M, \partial M)$, the subspace of functions $M \times I \rightarrow I$ which are the projection onto I on $M \times [0, \epsilon] \cup M \times [1 - \epsilon, 1] \cup \partial M \times I$; and $\hat{\mathcal{F}}(M, \partial M)$ by $\hat{\mathcal{F}}'(M, \partial M)$, the subspace for which the function belongs to $\mathcal{F}'(M, \partial M)$ and for which the metric is the product metric and the vector field is the gradient vector field on $M \times [0, \epsilon] \cup M \times [1 - \epsilon, 1] \cup \partial M \times I$. Here ϵ is a fixed small positive number. We also replace \mathcal{E} and $\hat{\mathcal{E}}$ by $\mathcal{E}' = \mathcal{E} \cap \mathcal{F}'$ and $\hat{\mathcal{E}}' = \hat{\mathcal{E}} \cap \hat{\mathcal{F}}'$. These replacements are justified up to homotopy type by [4] where it is shown that the inclusions $\mathcal{O}' \subset \mathcal{O}$, $(\mathcal{F}', \mathcal{E}') \subset (\mathcal{F}, \mathcal{E})$, and $(\hat{\mathcal{F}}', \hat{\mathcal{E}}') \subset (\hat{\mathcal{F}}, \hat{\mathcal{E}})$ are homotopy equivalences.

There are two kinds of suspensions: S^+ and S^- . We give the details of the construction of S^+ and leave the construction of S^- to the reader.

Let $I = [0, 1]$. Define $C \subset J \times I$ to be the set $C = J \times [0, 1 - \frac{\epsilon}{2}]$. Thus:

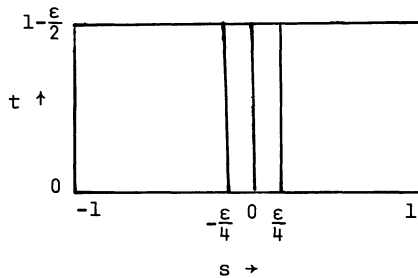

Define an embedding $\mathcal{Q}: C \rightarrow J \times I$ such that:

- (a) $\mathcal{Q}(1,t) = (1-t,1)$
- (b) $\mathcal{Q}(-1,t) = (t-1,1)$
- (c) $\mathcal{Q}(s,t) = (s,t+s^2)$ for $|s| < \frac{\epsilon}{4}$
- (d) for fixed $t \in [0, 1 - \frac{\epsilon}{2}]$ the map $s \rightarrow \mathcal{Q}(s,t)$ followed by the projection $J \times I \rightarrow I$ has a critical point only at $s = 0$.

Via the embedding \mathcal{Q} we can introduce coordinates u and v on the image $\mathcal{Q}(C)$ where the "horizontal" lines $v = \text{constant}$ are of the form $u = \mathcal{Q}(s,t)$, $t = \text{constant}$, and the "vertical" lines $u = \text{constant}$ are of the form $v = \mathcal{Q}(s,t)$, $s = \text{constant}$. See the diagram below.

PSEUDO-ISOTOPIES AND REAL VALUED FUNCTIONS

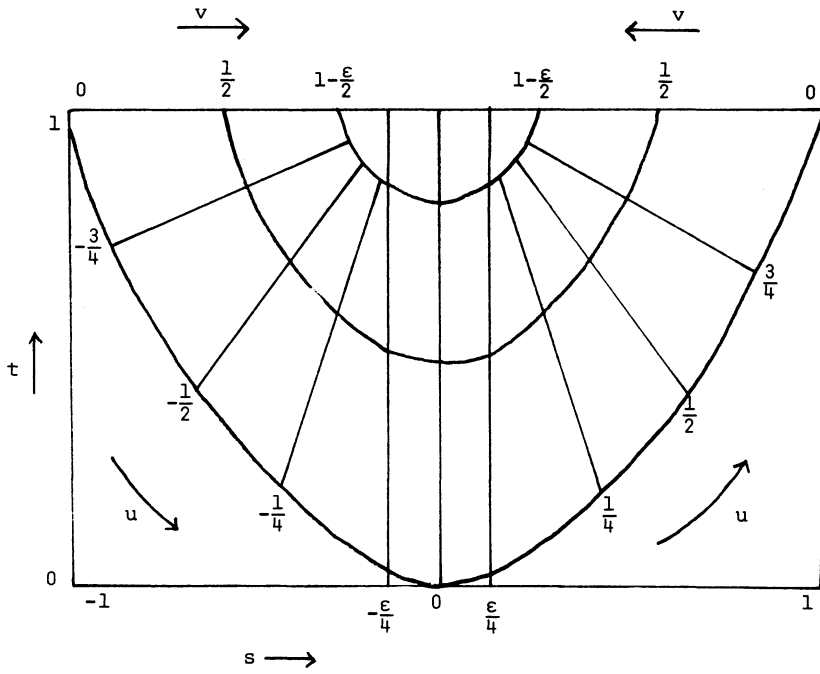

For $F \in \mathcal{P}^1(M, \partial M)$ define the suspension of F

$$S^+F \in \mathcal{P}(M \times J, \partial(M \times J))$$

to be $F|M \times [0, 1 - \frac{\epsilon}{2}]$ on each of the sections $M \times \{u = \text{constant}, 0 \leq v \leq 1 - \frac{\epsilon}{2}\}$, the identity below the "horizontal" line $v = 0$, and $F|M \times \{1\}$ on each slice $M \times \{s, t\}$ above the line $\{v = 1 - \frac{\epsilon}{2}\}$.

The pseudo-isotopy obtained by restricting S^+F to $M \times J \times \{1\}$ is the "double" of F .

Let $\pi: J \times I \rightarrow I$ be projection. If $f \in \mathcal{F}^1(M, \partial M)$, define $\bar{f}: M \times J \times I \rightarrow J \times I$ to be $f: M \times \{u = \text{constant}, 0 \leq v \leq 1 - \frac{\epsilon}{2}\} \rightarrow \{u = \text{constant}, 0 \leq v \leq 1 - \frac{\epsilon}{2}\}$ on each slice $M \times \{u = \text{constant}, 0 \leq v \leq 1 - \frac{\epsilon}{2}\}$ and the projection onto $J \times I$ elsewhere. Then let the suspension of f

$$S^+f \in \mathcal{F}(M \times J, \partial(M \times J))$$

be given by

$$S^+f = \pi \circ \bar{f} .$$

Then $S^+f|M \times \{0\} \times I = f$ and property (d) above implies

$$(5.1) \{\text{critical points of } S^+f\} = \{\text{critical points of } f\}$$

Furthermore, in a neighborhood of a critical point of S^+f we have

$$S^+f(x, u, v) = f(x, v) + u^2.$$

Next we extend S^+ to $\hat{\mathcal{F}}'$ by defining it on an element (η, f, μ) . Let μ_J and μ_I be the standard metrics on J and I respectively and let $\mu_0 = \mu|_{M \times \{0\}}$. On $M \times \mathcal{Q}(C)$ let $S^+\mu$ be induced by \mathcal{Q} from $\mu \times \mu_J$, and on $M \times J \times I - M \times \mathcal{Q}(C)$ let $S^+\mu$ be the product of μ_0 with a fixed extension of $\mathcal{Q}(\mu_J \times \mu_I)$ to $J \times I$.

To define $S^+\eta$, let $\bar{\eta}(x, u, v) = \eta(x, v) + 2u \cdot \frac{\partial}{\partial u}$ wherever the (u, v) coordinates are defined, and let $\rho: M \times J \times I \rightarrow I$ be a function which is 0 outside a neighborhood of $M \times \{0\} \times [\epsilon, 1-\epsilon]$ and 1 inside a smaller neighborhood of $M \times \{0\} \times [\epsilon, 1-\epsilon]$. Then set

$$S^+\eta = \rho \bar{\eta} + (1-\rho) \text{grad}_{\mu_0 \times \mu_J \times \mu_I}(S^+f)$$

It is easy to check that $S^+\eta$ is a gradient-like vector field for S^+f with respect to the metric $S^+\mu$. The continuous suspension map.

$$S^+: \hat{\mathcal{F}}'(M, \partial M) \rightarrow \hat{\mathcal{F}}(M \times J, \partial(M \times J))$$

is given by

$$S^+(\eta, f, \mu) = (S^+\eta, S^+f, S^+\mu) .$$

One defines S^- in a similar way but in a neighborhood of any critical point of S^-f we have $S^-f(x,u,v) = f(x,v) - u^2$.

Let $h: B \rightarrow \mathbb{R}$ be a C^∞ - function on a smooth manifold B with an isolated critical point p such that $h(p) = c$. Let η be a gradient like vector field for h and $\epsilon > 0$ be such that h has no other critical points than p in $h^{-1}([c-\epsilon, c+\epsilon])$. Define

$$\begin{aligned} W_\epsilon(p,h) &= W(p) \cap h^{-1}([c-\epsilon, c+\epsilon]) \\ W_\epsilon^*(p,h) &= W^*(p) \cap h^{-1}([c-\epsilon, c+\epsilon]) \\ \partial W_\epsilon(p,h) &= W(p) \cap h^{-1}(c-\epsilon) \\ \partial W_\epsilon^*(p,h) &= W^*(p) \cap h^{-1}(c+\epsilon). \end{aligned}$$

For any two isolated critical points p and q of f we have

$$(5.2) \quad W(p, S^\pm f) \cap W^*(q, S^\pm f) = W(p, f) \cap W^*(q, f).$$

Furthermore, if p is an isolated critical point of f , then

$$(5.3) \quad \begin{aligned} (W_\epsilon(p, S^+ f), \partial W_\epsilon(p, S^+ f)) &\cong (W_\epsilon(p, f), \partial W_\epsilon(p, f)) \\ (W_\epsilon^*(p, S^+ f), \partial W_\epsilon^*(p, S^+ f)) &\cong (S W_\epsilon^*(p, f), S \partial W_\epsilon^*(p, f)) \\ (W_\epsilon(p, S^- f), \partial W_\epsilon(p, S^- f)) &\cong (S W_\epsilon(p, f), S \partial W_\epsilon(p, f)) \\ (W_\epsilon^*(p, S^- f), \partial W_\epsilon^*(p, S^- f)) &\cong (W_\epsilon^*(p, f), \partial W_\epsilon^*(p, f)) \end{aligned}$$

where the capital S on the right-hand side denotes ordinary suspension of topological spaces. Compare [10].

Remark 1. Under suspension the space \mathfrak{E}_M of functions $(M \times I; M \times 0, M \times 1) \rightarrow (I; 0, 1)$ which have no critical points and are the standard projection near $\partial M \times I$ gets mapped to the corresponding space $\mathfrak{E}_{M \times J}$ for the manifold $M \times J$. If $\dim M \geq 7$ the main result of this paper shows there is an isomorphism

$$\pi_0(\mathfrak{E}_M) \cong \pi_0(\mathfrak{E}_{M \times J})$$

Can this fact somehow be derived in a direct way?

Remark 2. By repeating the suspension construction a number of times one can, by (5.3), increase the codimensions of both the stable and unstable sets of all the critical points and also make the pairs $(W_\epsilon, \partial W_\epsilon)$ and $(W_\epsilon^*, \partial W_\epsilon^*)$ as highly connected as might be desired.

§6. Independence of birth and death points.

Let η be a nice gradient-like vector field for f . Two critical points p and q of f are called independent (for η) if

$$(W(p) \cup W^*(p)) \cap (W(q) \cup W^*(q)) = \phi.$$

A single critical point is independent (for η) provided it is independent of all other critical points of f .

Lemma 6.1. Let (η_t, f_t) be a nice one-parameter family. Suppose all the critical points p of each f_t satisfy $1 \leq \text{index } p \leq n$. Then η_t can be deformed to a nice one-parameter family of gradient-like vector fields for which all birth-death singularities of the f_t are independent.

Proof. To make a birth-death critical point p of a particular f_t independent of all the critical points q of f_t with $f_t(p) > f_t(q)$ we deform η_t near p by an isotopy of the level surface L just below p as follows: Choose a point x in the interior of the disc $W(p) \cap L$. By a small isotopy of the level surface deform η_t so that $W^*(q) \cap L$ doesn't hit x . This can be done because $\text{index } q > 0$ implies $W^*(q) \cap L$ will have positive codimension in L . Now by an isotopy of L shrink the discs $W(p) \cap L$ concentrically into a small neighborhood of x so that $W(p) \cap L$ and $W^*(q) \cap L$ don't meet. Repeat this procedure for all the critical points below p ; then by a similar argument make p

independent of all the critical points above it.

Remark 6.2. Suppose (η_z, f_z) is a 2-parameter family such that for each critical point p of any f_z we have $1 < \text{index } p < n$. Then an argument similar to the one above can be used to make all the birth-death critical points independent except in a small neighborhood of a dovetail point. See (C) of §2 of IV below.

§7. Independent Trajectories.

In this section we give some ways in which the graphic of a k -parameter family (η_z, f_z) can be changed by a deformation of (η_z, f_z) .

Independent Trajectories Principle.

This says, roughly, that whenever the stable and unstable sets from critical points corresponding to one part in the graphic don't intersect those from another part of the graphic we can realize any deformation of these two parts of the graphic relative to one another by an actual deformation of (η_z, f_z) .

Example. Suppose the graphic of a path (η_t, f_t) , $0 \leq t \leq 1$, looks like

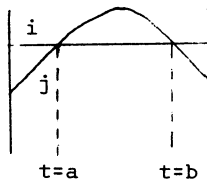

and suppose that (η_t, f_t) is in general position. If $j < i$ then for $a \leq t \leq b$

$$W(p_t) \cap W^*(q_t) = \emptyset$$

where p_t is the critical point of f_t of index j and q_t is the critical point of f_t of index i . The independent trajectories

lemma below says that the following deformation in the graphic can be realized by a deformation of (η_t, f_t) which keeps end points fixed:

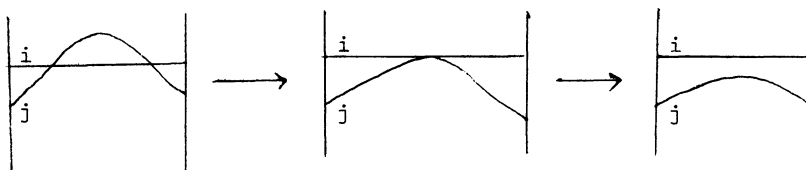

The proof of the independent trajectories lemma is a direct generalization of the argument for the Preliminary Rearrangement Theorem 4.1 of [18].

Lemma (7.1). (Independent Trajectories). Suppose (η_z, f_z) is a nice k -parameter family ($0 \leq k \leq 2$) where z belongs to a parameter domain $D \subset D^k$ which is a compact k -submanifold with boundary of D^k . Let $\Sigma \subset D \times V$ be the singular set of the map $F: D \times V \rightarrow D \times R$ and let $C \subset \Sigma$ be the union of some of the components of Σ . Let $\alpha_1, \alpha_2: D \rightarrow R$ be C^∞ functions.

Assume

- (a) $\alpha_1(z) < f_z(p) < \alpha_2(z)$ for any $p \in C_z = C \cap (z \times V)$
- (b) Let $K_z = f_z^{-1}([\alpha_1(z), \alpha_2(z)]) \cap \left[\bigcup_{p \in C_z} (W(p) \cup W^*(p)) \right]$ and suppose that the compact set K_z does not intersect $W(q) \cup W^*(q)$ for any critical point q in $f_z^{-1}([\alpha_1(z), \alpha_2(z)])$ but not in C_z .

Then if $\beta_1, \beta_2: D \rightarrow \mathbb{R}$ are any two C^∞ -functions satisfying $\alpha_1(z) \leq \beta_1(z) < \beta_2(z) \leq \alpha_2(z)$ the family (η_z, f_z) can be deformed to a nice family (η_z, g_z) satisfying

- (i) each g_z has the same critical points as f_z and moreover for any critical point p of f_z there is a constant $c_z(p)$ such that $g_z = f_z + c_z(p)$ in a neighborhood of p in $z \times V$.
- (ii) $\beta_1(z) < g_z(p) < \beta_2(z)$ for all $p \in C_z$
- (iii) if $\beta_1(z) = \alpha_1(z)$ and $\beta_2(z) = \alpha_2(z)$, then $g_z = f_z$.

Note that η_z was not changed so the intersections of the stable and unstable manifolds in $z \times V$ remains the same.

A typical transformation by independent trajectories ($k=1$) might look like

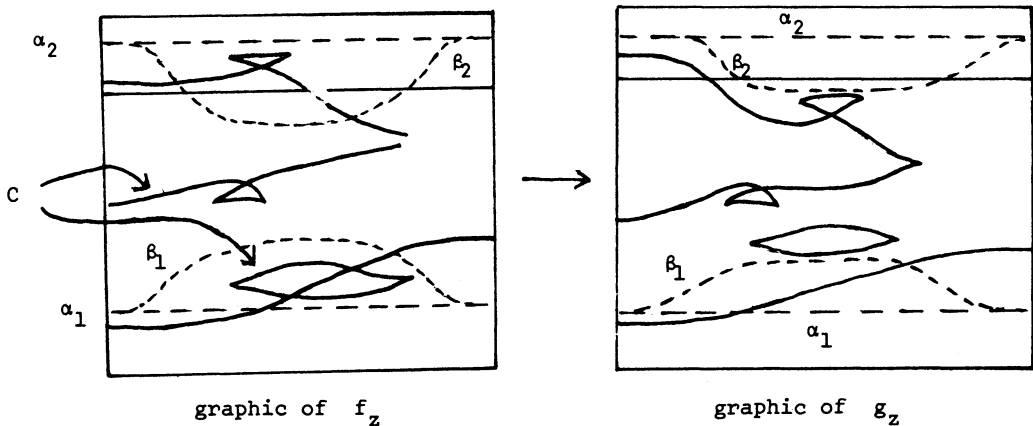

Proof. Let $K = \bigcup_{z \in D} K_z \subset D \times V$. Using an argument similar to [18, Th. 4.1] we can use condition (b) to find neighborhoods $U_1 \subset U_2$ of K in $D \times V$ and to find a smooth function $\rho: D \times V \rightarrow [0,1]$ such that

- (1) the closure of U_2 contains no critical points other than those in C
- (2) $\rho \equiv 1$ on U_1 and $\rho \equiv 0$ outside U_2
- (3) Let $\rho_z = \rho|_{z \times V}$. Let p be a point of $z \times V$ not in K_z and suppose $\alpha_1(z) < f_z(p) < \alpha_2(z)$. Then ρ_z is constant on the part of the trajectory of η_z through p which lies in $f_z^{-1}([\alpha_1(z), \alpha_2(z)])$.

Now as in [18, Th. 4.1] construct a smooth k -parameter family of maps $G_z(t,r): R \times [0,1] \rightarrow R$ such that

- (4) for each fixed $r \in [0,1]$, $G_z(\cdot, r)$ is a diffeomorphism of R with support contained in $[\alpha_1(z), \alpha_2(z)]$
- (5) $\frac{\partial G_z}{\partial t}(t,r) = 1$ for t near any critical value of f_z
- (6) $\beta_1(z) < G_z(f_z(p), 1) < \beta_2(z)$ for $p \in C_z$
- (7) $G_z(\cdot, 0) = \text{identity}$ for all z
- (8) If $\beta_1(z) = \alpha_1(z)$ and $\beta_2(z) = \alpha_2(z)$ then $G_z(\cdot, r) = \text{identity}$ for all $r \in [0,1]$

The required deformation from $f_z = G_z(f_z, 0)$ to $g_z = G_z(f_z, \rho)$ is the path

$$G_z(f_z(x), s \cdot \rho(x))$$

for $0 \leq s \leq 1$ and $x \in V$.

§8. One and two parameter ordering.

This section gives two propositions which show how to simplify the graphics of one and two parameter families using only general position arguments and the independent trajectories principle put together by a somewhat involved induction process. The propositions stated are not the most general possible but they are what we need to construct the Wh_2 invariant and show it is well-defined.

A function $f: V^{n+1} \rightarrow R$ is ordered provided that $\text{index}(p) > \text{index}(q)$ implies $f(p) > f(q)$.

Proposition 8.1. (One parameter ordering. Compare [3; Chap. V, §1])

Let $V = M^n \times I$ and let (η_t, f_t) be a one parameter family where $f_t: M \times I \rightarrow I$ is such that f_0 and f_1 lie in \mathcal{E} . Then (η_t, f_t) can be deformed keeping (η_0, f_0) and (η_1, f_1) fixed so that it becomes a nice one parameter family satisfying the following properties:

- (1) For all t , $f_t \in \mathcal{F}^0 \cup \mathcal{F}^1$ and the one parameter family f_t is generic in the sense of §2. Thus there are only finitely many crossings (which occur when $f_t \in \mathcal{F}_\beta^1$) and only finitely many birth and death points and these all occur at different times.
- (2) Let $0 < r_0 < r_1 < \dots < r_n < 1$ be chosen in advance. If p is a non-degenerate critical point of any f_t of index i then $r_{i-1} < f_t(p) < r_i$. If p is a birth or death point of index i then $f_t(p) = r_i$. Thus each f_t is ordered.

- (3) If f_t is a generic family to begin with and each critical point of each f_t satisfies $0 < \text{index}(p) < n+1$, then the deformation of (η_t, f_t) can be made so that birth and death points become independent.

Proof of one parameter ordering (see [3] also).

First deform (η_t, f_t) to a nice family where the one parameter family f_t is generic as in §2. There will be only finitely many times $0 < t_0 < \dots < t_m < 1$ such that f_{t_i} has exactly one birth or death point and for $t \neq t_i$, f_t has only non-degenerate critical points. Now use general position and the independent trajectories principle as in [3] to deform (η_t, f_t) so that for a small number $\delta > 0$, f_t satisfies condition (2) above whenever $t \in [t_i - \delta, t_i + \delta]$. If the index λ of each birth or death point satisfies $1 \leq \lambda \leq n$ then (6.1) insures that independence of the birth or death point of each f_{t_i} can be obtained. Now use the techniques of the two examples in §4 and §7 to further deform (η_t, f_t) until condition (2) is satisfied for all $t \in [0, 1]$. q.e.d.

Suppose now that we have chosen a sequence $0 < r_0 < r_1 < \dots < r_n < 1$ and have two paths (η_t, f_t) and (ξ_t, g_t) , $0 \leq t \leq 1$, such that $(\eta_0, f_0) = (\xi_0, g_0)$ and $(\eta_1, f_1) = (\xi_1, g_1)$ and such that the paths satisfy (8.1). Suppose that for any critical point p of any f_t or g_t we have $2 \leq \text{index}(p) \leq n - 1$. As in §2 there is a nice two parameter family $(\gamma_{t,s}, h_{t,s})$ such that

$(\eta_t, f_t) = (\gamma_{t,0}, h_{t,0})$ and $(\xi_t, g_t) = (\gamma_{t,1}, h_{t,1})$ for $0 \leq t \leq 1$
and

$(\gamma_{0,s}, h_{0,s}) = (\eta_0, f_0)$ and $(\gamma_{1,s}, h_{1,s}) = (\eta_1, f_1)$ for $0 \leq s \leq 1$.

Proposition (8.2) (Two parameter ordering). Suppose for all parameter values $z = (t,s) \in I \times I$ that $2 \leq \text{index } p \leq n-1$ for any critical point p of h_z . Then (γ_z, h_z) can be deformed keeping things fixed for $z \in \partial(I \times I)$ until it is a nice gradient-like family which satisfies the following conditions:

There are finitely many parameter values y_1, \dots, y_u and z_1, \dots, z_v in interior of $I \times I$ and neighborhoods U and V of the y_i 's and z_j 's respectively such that

- (1) If p is a non-degenerate critical point of h_z of index i and $z \in U$ then $r_{i-1} < h_z(p) < r_i$. For each z inside the neighborhood U the change in the graphic is

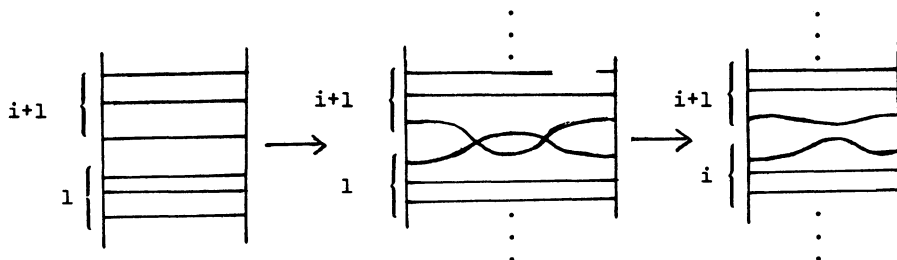

In fact for all $z \in U$, h_z has only non-degenerate critical points.

- (2) For $z \in V$ each function h_z is ordered and the change in graphic is

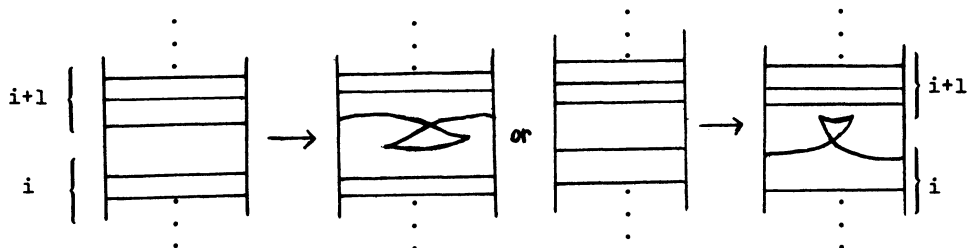

or the reverse of these two.

(3) If p is a birth point of index i of h_z and $z \notin V$ then $h_z(p) = r_i$. Furthermore, for $z \notin V$ the birth and death points of h_z are independent.

Theorems (8.1) and (8.2) should be compared with the tables " \mathcal{F}^1 graphics" and " \mathcal{F}^2 graphics" in §2. Consider for example, a two parameter family passing through $\mathcal{F}_\varepsilon^2$ with graphic

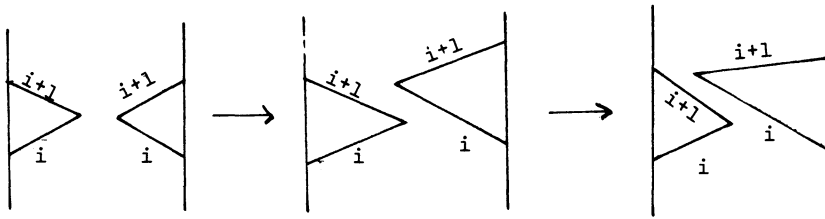

In a two parameter ordered family this would be changed to

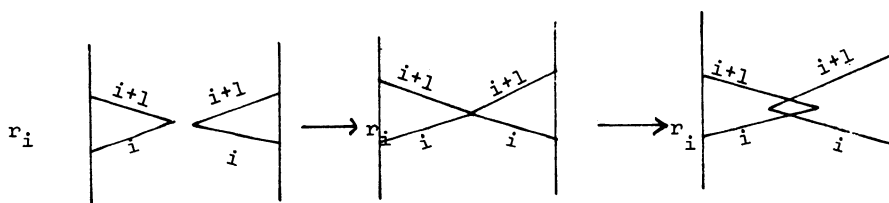

That this graphic is not in general position is of no concern. The important thing is that the corresponding birth-death critical points in V^{n+1} are independent.

Outline of proof of (8.2).

As in §2 we can assume the changes in the graphic of $(\gamma_{t,s}, h_{t,s})$ as s goes from 0 to 1 are those in " \mathbb{R}^2 graphics". Let $\Gamma \subset I \times I$ be that part of the trace of the two parameter family consisting of those parameters $z = (t,s)$ such that h_z has either a birth-death critical point or a dovetail critical point. The parameters where birth-death points (resp. a dovetail point) occur will be called birth-death parameters (resp. dovetail parameters). There are only finitely many dovetail parameters and the set of birth-death parameters consists of finitely many arcs and circles which intersect transversely in $I \times I$.

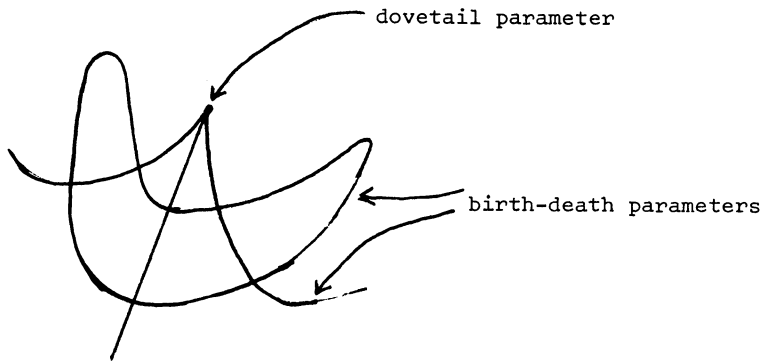

For each dovetail parameter z we can use general position and the independent trajectories principle to deform (η_z, h_z) until it is ordered and satisfies $r_{i-1} < h_z(p) < r_i$ whenever index $p = i$. Extend this deformation to one of (γ_z, h_z) $z \in I \times I$, such that for z varying in a small neighborhood V of the dovetail parameters

the change in the graphic is like condition (2) above. This can be done without changing Γ although the graphic must certainly be altered. In a similar way deform (γ_z, h_z) keeping things fixed on $\partial(I \times I) \cup V$ and without changing Γ so that for each birth-death parameter z lying in the intersection of two birth-death components of Γ the function h_z satisfies (2) of (8.1). In fact, this can be done so that (2) of (8.1) is satisfied by h_z for z in a small neighborhood W of these intersection points. At this point the closure of $\Gamma - V - W$ is the union of finitely many arcs $\alpha_1, \alpha_2, \dots, \alpha_p$ such that for z an end point of any α_j the function h_z satisfies (2) of (8.1). Consider the one-parameter family (γ_z, h_z) where z runs through α_1 . Using the one parameter ordering methods, deform (γ_z, h_z) , $z \in \alpha_1$, until (2) of (8.1) is satisfied for all $z \in \alpha_1$. Extend this deformation to parameters running through a small neighborhood of α_1 so that (2) of (8.1) still holds. Do this for the other arcs $\alpha_2, \dots, \alpha_p$. Thus for a small neighborhood E of Γ conditions (2) and (3) of (8.2) are satisfied along with condition (2) of (8.1) for $z \in E - V$. The proof of (8.2) has thus been reduced to (8.3) below.

Let $D \subset \text{interior of } I \times I$ be a bounded two dimensional manifold. Let $0 < r_0 < r_1 < \dots < r_n < 1$ be fixed.

Lemma 8.3. Suppose (γ_z, h_z) is a two parameter family where z runs through D such that each h_z has only non-degenerate critical points and $r_{i-1} < h_z(p) < r_i$ whenever $z \in \partial D$ and index $p = i$. Then (γ_z, h_z) can be deformed rel ∂D in the space

of Morse functions with only non-degenerate critical points until condition (1) of (8.2) is satisfied.

A detailed proof of (8.3) requires a somewhat involved induction process. We shall only give here an example illustrating the technique of proof and one of the main points in the argument.

First consider a deformation of the graphic like

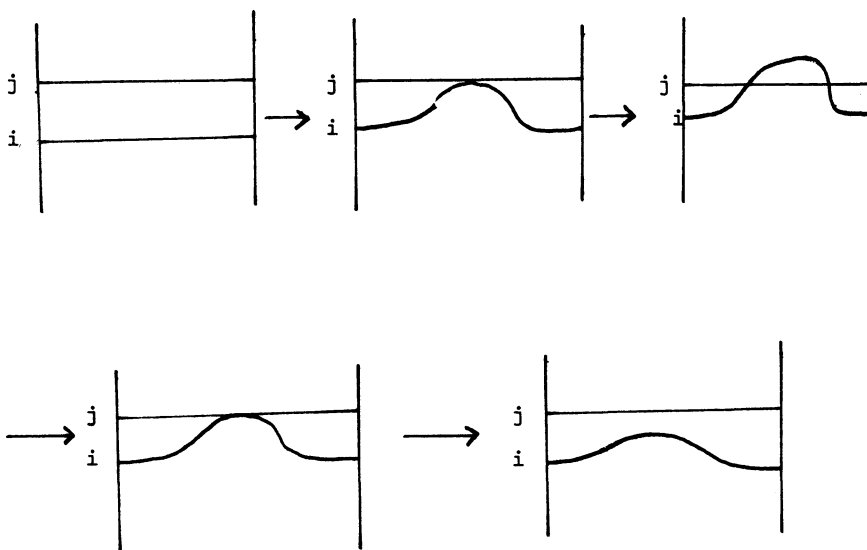

The trace of this two parameter family is

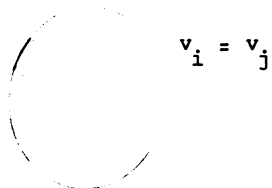

where the symbol $v_i = v_j$ indicates that for a parameter z in the circle h_z has a critical point p_z of index i and a critical point q_z of index j with the same critical values. For z in a small neighborhood of the circle, $W^*(p_z) \cup W(p_z)$ and $W(q_z) \cup W^*(q_z)$ don't intersect. For z inside the circle, let $S_z^{i-1} = W(p_z) \cap$ a level surface between $f(p_z)$ and $f(q_z)$ and let $S_z^{n-j} = W^*(q_z) \cap$ the same level surface. By a small deformation place the two parameter family γ_z into general position. If $i < j - 1$ then $W(p_z) \cap W^*(q_z) = \emptyset$ for all z inside the circle. If $j = i + 1$, then we still have $W(p_z) \cap W^*(q_z) = \emptyset$ except for finitely many parameter values where an $i/i+1$ crossing occurs. This will be denoted by a small "cross" as in the diagram

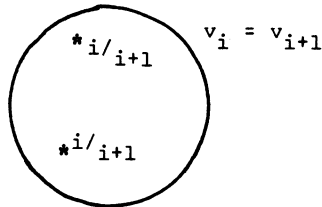

The independent trajectories principle shows that if no $i/i+1$ crossings occur inside the circle then (γ_z, h_z) can be deformed to eliminate the circle from the trace.

Now consider the two parameter family

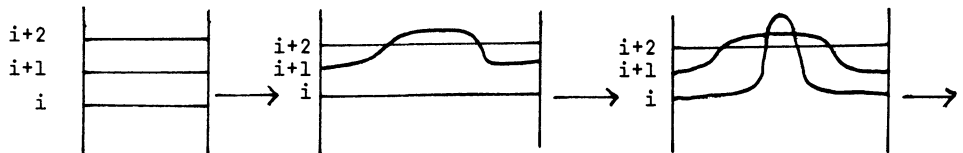

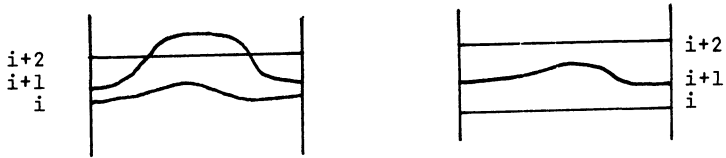

Its trace is

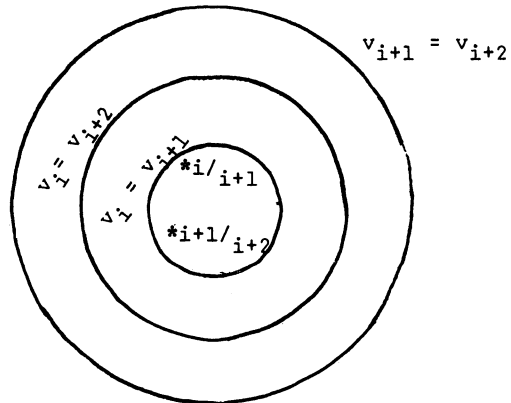

Here we suppose there is just one $i/i+1$ crossing and one $i+1/i+2$ crossing within the innermost circle which by general position can be assumed to occur at different parameter values. If no $i/i+1$ crossings were present then the independent trajectories principle would allow deformation of the two parameter family to one with a graphic like

PSEUDO-ISOTOPIES AND REAL VALUED FUNCTIONS

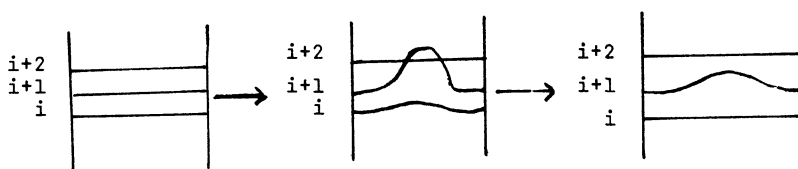

which satisfies (1) of (8.2). It is still possible to eliminate the $v_i = v_{i+2}$ circle using independent trajectories as follows:

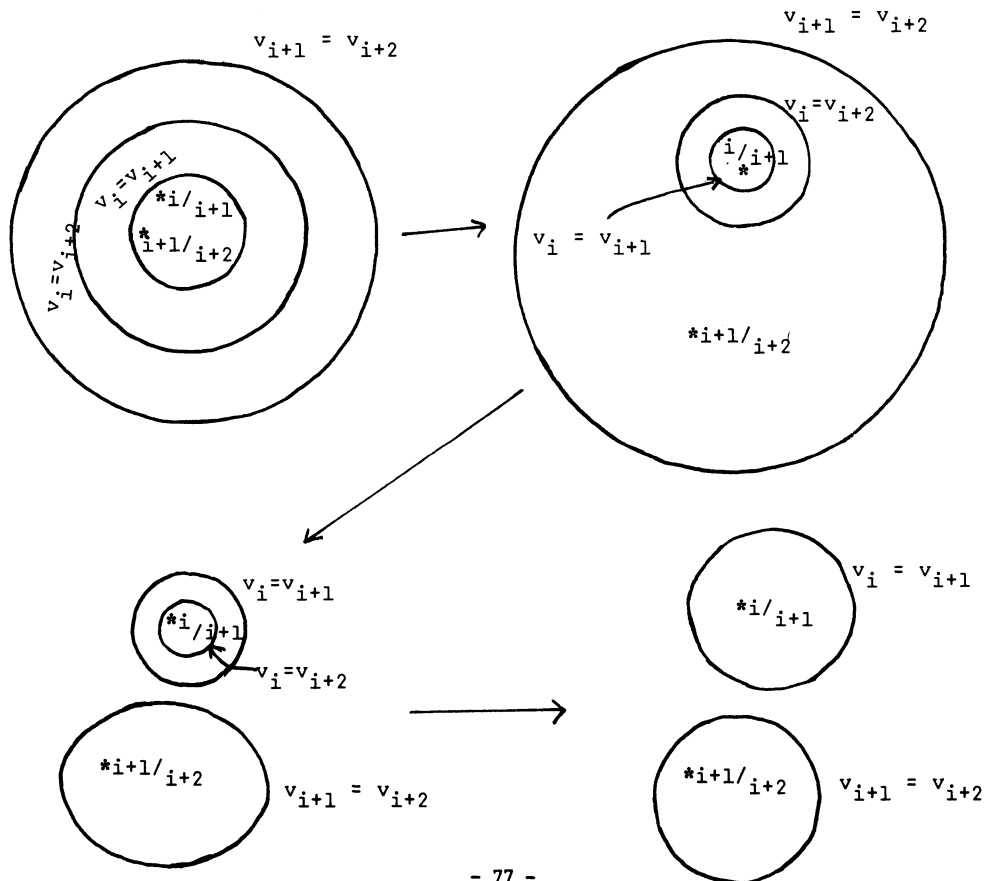

A one dimensional cross section in the graphic of this deformation is

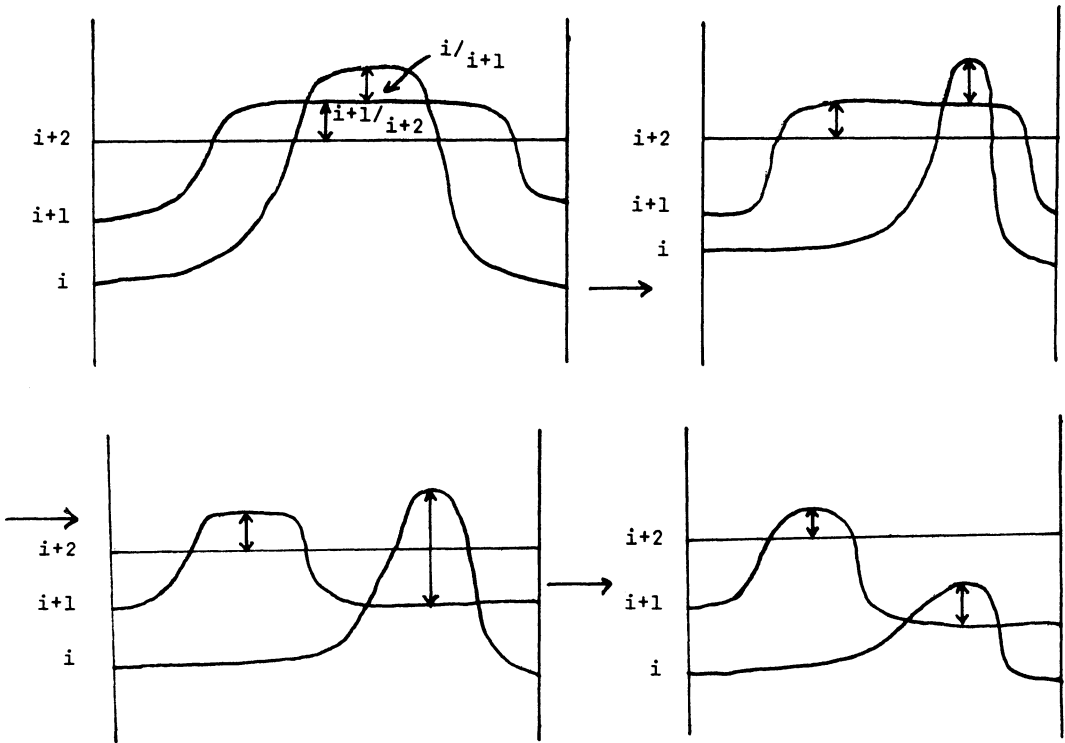

The vertical arrows indicate $i/i+1$ and $i+1/i+2$ crossings.

CHAPTER II. Geometry of the Steinberg Group

§1. Geometric realization of the Steinberg group.

Let V be a connected $(n+1)$ -manifold with two boundary components C and D . Suppose there is a function $g: (V; C, D) \rightarrow (I; 0, 1)$ satisfying

(*) g has exactly r critical points each of which is non-degenerate of index i .

The critical values of g need not be distinct. Let \mathcal{a} be the space of pairs (η, f) ⁽¹⁾ where f satisfies (*) and η is gradient-like for f . Let $\mathcal{B} \subset \mathcal{a}$ be the subspace consisting of pairs (η, f) such that if p and q are critical points of f then

$$[W(p) \cup W^*(p)] \cap [W(q) \cup W^*(q)] = \phi.$$

Thus the pairs (η, f) of \mathcal{B} are precisely those of \mathcal{a} which are in general position.

If $3 \leq r < \infty$ and Λ is a ring let $St(r, \Lambda)$ denote the Steinberg group generated by the symbols $x_{pq}(\lambda)$, where $1 \leq p, q \leq r$, modulo the relations given in the Introduction.

In this section we prove

(1) Really the space of triples (η, f, μ) as in §3 of Chap. I.

Theorem 1.1. Let $r \geq 3$. Suppose that $3 \leq i \leq n - 2$ or that $2 \leq i \leq n - 2$ and $\pi_1(C) \rightarrow \pi_1(V)$ is a monomorphism. Then there is a bijection

$$\Delta : \text{St}(r, Z[\pi_1 V]) \xrightarrow{\cong} \pi_1(\mathcal{B}, \mathcal{B}; (\eta_0, f_0))$$

for any base point $(\eta_0, f_0) \in \mathcal{B}$.

Consider any $(\zeta, h) \in \mathcal{B}$. Let p_1, \dots, p_r be an ordering of the critical points of h and let γ_j be a path from a fixed base point to p_j . Choose an orientation for each stable manifold $W(p_j)$. This data determines a $Z[\pi_1 V]$ -basis $\epsilon_1, \dots, \epsilon_r$ for $H_i(\tilde{V}, \tilde{C})$ where $\tilde{V} \rightarrow V$ is the universal cover and $\tilde{C} \subset \tilde{V}$ is the part lying over C . Let p_α and p_β be two critical points of h with $h(p_\alpha) > h(p_\beta)$ and let $x_{\alpha\beta}^\lambda$ be a Steinberg generator with $\lambda \in Z[\pi_1 V]$.

Lemma 1.2. Under the above conditions there is a path

$x_{\alpha\beta}^\lambda \cdot (\zeta, h) = (\zeta_t, h_t)$ in $(0 \leq t \leq 1)$ such that $h_t = h$ for all t , $\zeta_0 = \zeta$, $(\zeta_1, h_1) \in \mathcal{B}$, and such that the stable manifolds of ζ_1 determine the basis

$$\epsilon_1, \dots, \epsilon_\alpha + \lambda \cdot \epsilon_\beta, \dots, \epsilon_\beta, \dots, \epsilon_r \text{ of } H_i(\tilde{V}, \tilde{C}).$$

Remark. The critical points of h_1 will be ordered and based and the stable manifolds oriented according to the following convention. Let (ζ_t, h_t) be any path starting from (ζ_0, h_0) . The critical set of the map $H: I \times V \rightarrow I \times R$ where $H(t, x) = (t, h_t(x))$ consists of a collection of arcs $a_1(t), \dots, a_r(t)$ ordered by the

condition that $a_1(0) = p_1, \dots, a_r(0) = p_r$. The j^{th} critical point of q_j of h_1 is defined by $q_j = a_j(1)$. The base path for q_j is just the path γ_j followed by the path $a_j(t)$. The orientation for $W(q_j)$ is the one which transports back along the path $a_j(t)$ to the given orientation of $W(p_j)$. In the following proof we will let $W_t(p)$ and $W_t^*(p)$ denote the stable and unstable sets of a critical point p of h_t with respect to the gradient-like field ζ_t .

Proof of 1.2. This follows the handle addition theorem in the theory of s-cobordisms. See [16] and [18, Th. 7.6]. We shall give the argument in the case $\lambda = \pm g$ for $g \in \pi_1 V$. Choose an intermediate value c between $h(p_\alpha)$ and $h(p_\beta)$ and let $S^{i-1} = W(p_\alpha) \cap h^{-1}(c)$ and $S^{n-i} = W^*(p_\beta) \cap h^{-1}(c)$. Orient S^{i-1} as the boundary of $D^i = W(p_\alpha) \cap \{x | h(x) \geq c\}$ in such a way that the orientation of S^{i-1} followed by the inward normal gives the chosen orientation of D^i . The orientation of $W(p_\beta)$ determines an orientation of the normal bundle of S^{n-i} in $h^{-1}(c)$. The spheres S^{i-1} and S^{n-i} shall be considered as based by γ_α and γ_β by extending γ_α and γ_β respectively by an arc in $W(p_\alpha)$ from p_α to S^{i-1} and an arc in $W^*(p_\beta)$ from p_β to S^{n-i} . Now choose an arc γ in $h^{-1}(c)$ between a point of S^{i-1} and a point of S^{n-i} such that $g = \gamma_\alpha * \gamma * \gamma_\beta^{-1}$ and such that γ misses $W(p_j) \cup W^*(p_j)$ for $j \neq \alpha$ or β . Suppose that γ intersects S^{i-1} and S^{n-i} only at its end points. See the diagram below. There is an embedding $\theta: S^{i-1} \times I \rightarrow h^{-1}(c)$ with image contained in a small neighborhood N of $S^{i-1} \cup \gamma$ such that $\theta(S^{i-1} \times 0) = S^{i-1}$ and $\theta(S^{i-1} \times I) \cap S^{n-i}$ is exactly one transverse point, say $\theta(x, a)$.

for $0 < a < 1$. Furthermore, we can choose θ so that the product orientation of $\theta(S^{i-1} \times I)$ either agrees or disagrees with the orientation of the normal bundle for S^{n-i} depending upon the sign in $\pm g$. The imbedding θ can be realized by an ambient isotopy of $h^{-1}(c)$ with support in N . This isotopy then determines the desired deformation (ζ_t, h_t) of (ζ_0, h_0) .

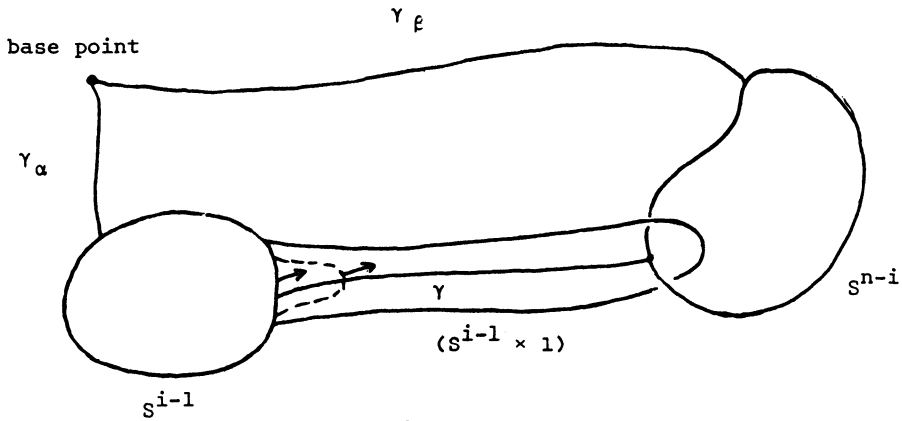
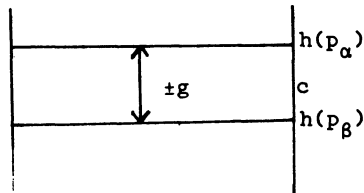

Diagram 1

The path (ζ_t, h_t) constructed above is in general position. For $t \neq a$, $(\zeta_t, h_t) \in \mathcal{C}$. However, $W_a(p_\alpha) \cap W_a^*(p_\beta) \neq \emptyset$ while $W_a^*(p) \cap W_a(q) = \emptyset$ for any other pair of critical points p and q of h . This situation is described on the graphic of the path h_t by a vertical arrow as follows:



$t = a$

GEOMETRY OF THE STEINBERG GROUP

This path will be called an elementary gradient crossing path or an i/i -intersection path. It is the model for a transverse i/i intersection for a one parameter family. See [3; Chap. I, §4] or [18, Figure 7.2].

Now to construct $x_{\alpha\beta}^{\lambda} \cdot (\zeta, h)$ as desired in (1.2) for any $\lambda \in Z[\pi_1 V]$ write $\lambda = \sum_{j=1}^m \pm g_j$ where $g_j \in \pi_1 V$ and let

$$x_{\alpha\beta}^{\lambda} \cdot (\zeta, h) = x_{\alpha\beta}(\pm g_m) \cdot (\dots (x_{\alpha\beta}(\pm g_1) \cdot (\zeta, h)) \dots)$$

That this construction yields a well-defined element of $\pi_1(\ , ; (\eta_0, f_0))$ follows from

Lemma 1.2'. Under the hypotheses of (1.1) we can realize the following changes in the graphic by a deformation of (ζ_t, h_t) keeping (η_0, f_0) and (η_1, f_1) fixed for any $\mu, \nu \in \pm\pi_1 V$

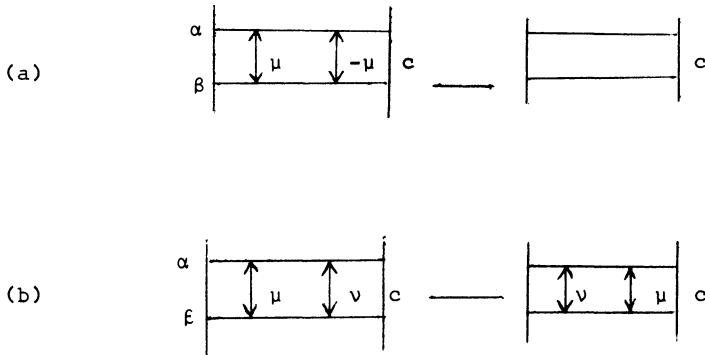

Proof of (a). This is just a one parameter version of the Whitney-Smale procedure for cancelling pairs of intersection points. In an intermediate c -level $W = h^{-1}(c)$ (for simplicity we assume $h_t = h$ for all t) we have the isotopies $S_t^{i-1} = W(p_\alpha(t)) \cap W$ and $S_t^{n-i} = W^*(p_\beta(t)) \cap W$. Let $S^{i-1} \times I \cap S^{n-i} \times I = \{p_1, p_2\} \subset W \times I$ be the two points where the gradient crossings (i.e. i/i -intersections) occur. Connect p_1 and p_2 by arcs α_1 and α_2 in $S^{i-1} \times I$ and $S^{n-i} \times I$ respectively which are transversal to each "t-slice" $t \times W$. We want to find an imbedded disc D^2 in $W \times I$ transverse to each t-slice and intersecting $S^{i-1} \times I \cup S^{n-i} \times I$ only in $\partial D^2 = \alpha_1 \cup \alpha_2$ as in the diagram

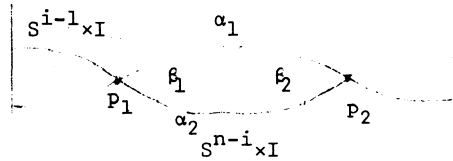

Let $B \times I \subset W \times I$ denote the union over t of the sets $B_t = \bigcup_\delta (W^*(p_\delta(t)) \cap W \times t)$ where $p_\delta(t)$ is any critical point below $p_\beta(t)$. Since there are no i/i -intersections other than those between p_α and p_β we have $B_t \cap S_t^{i-1} = \emptyset$ and $S_t^{n-i} \cap B_t = \emptyset$.

Near p_1 and p_2 it is easy to find the part of D^2 up to the arcs β_1 and β_2 connecting α_1 and α_2 . We can take the arcs β_1 and β_2 to miss $B \times I$. Between β_1 and β_2 the families S_t^{i-1} , S_t^{n-i} , and B_t form an isotopy of the disjoint union $S^{i-1} \cup S^{n-i} \cup B$ which, by isotopy extension, we may take to be the constant isotopy so that β_1 and β_2 become two paths in W with the same endpoints.

Claim. β_1 and β_2 are homotopic in $W - (S^{i-1} \cup S^{n-i} \cup B)$ keeping endpoints fixed.

Consider the sequence

$$\begin{aligned} \pi_1(W - (S^{i-1} \cup S^{n-i} \cup B)) &\rightarrow \pi_1(W - (S^{n-i} \cup B)) \\ &\rightarrow \pi_1(C - X^{i-1}) \rightarrow \pi_1(C) \rightarrow \pi_1 W \end{aligned}$$

where $X^{i-1} = [W(p_\beta) \cup (\bigcup_{\delta} W(p_\delta))] \cap C$. The first and third arrows are isomorphisms because $n - (i - 1) \geq 3$. The second is an isomorphism because $W - (S^{n-i} \cup B) \cong C - X^{i-1}$. The last arrow is a monomorphism by hypothesis. Hence the claim follows because β_1 and β_2 are homotopic in V since the two i/i intersections have invariant μ and $-\mu$.

To fill in the rest of D^2 we observe that homotopic arcs in a manifold of dimension at least four are isotopic by general position, so that β_1 and β_2 are isotopic in $W - (S^{i-1} \cup S^{n-i} \cup B)$. Now that D^2 has been constructed the rest of the argument is a straight forward one parameter version of the exposition in [18, Th. 6.6].

Proof of (b). Suppose that reading from the left the first i/i -crossing $x_{\alpha\beta}(\mu)$ occurs at time $t = a$. As in Diagram 1 choose an arc γ in the a -slice from S^{i-1} to S^{n-i} such that $\gamma_\alpha * \gamma * \gamma_\beta^{-1} = g$ where $v = \pm g$. Now in the a -slice deform S^{i-1} across S^{n-i} with intersection number ± 1 depending on the sign of v in $\pm \pi_1 V$. Extend this to an isotopy of S_t^{i-1} for t near a as in the diagram

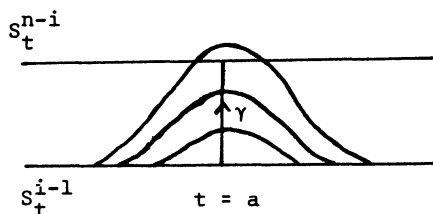

Since $i - 1 \geq 1$ and $n - i \geq 2$ we can do this without affecting the original i/i -crossing $x_{\alpha\beta}(\mu)$ which occurs at $t = a$. The change in the graphic is

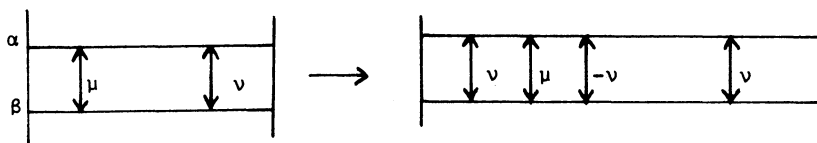

Now cancel out the last two gradient crossings using part (a) above.

Addendum 1. In case $h(p_\alpha) < h(p_\beta)$ the path (ζ_t, h_t) realizing the change of basis as in (1.2) can be obtained by first applying the independent trajectories lemma (to a 0-parameter family) to get a path (ζ'_t, h'_t) in \mathcal{B} from (ζ, h) to (ζ', h') where $h'(p_\alpha) > h'(p_\beta)$. Then use the proof of (1.2) to produce the required gradient crossings.

Addendum 2. As a converse to the handle addition lemma above suppose (ζ_t, h_t) is a path in \mathcal{a} with end points (ζ_0, h_0) and (ζ_1, h_1) in \mathcal{B} and suppose the graphic looks like

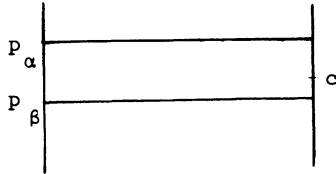

Choose an intermediate level c between $h_t(p_\alpha)$ and $h_t(p_\beta)$ and let $S_t^{i-1} = W(p_\alpha(t)) \cap h_t^{-1}(c)$ and $S_t^{n-i} = W^*(p_\beta(t)) \cap h_t^{-1}(c)$. By an isotopy of the level surfaces $h_t^{-1}(c)$ deform ζ_t keeping ζ_0 and ζ_1 fixed so that the level preserving maps $S^{i-1} \times I \rightarrow h_0^{-1}(c) \times I$ and $S^{n-i} \times I \rightarrow h_0^{-1}(c) \times I$ are in general position. Then there will be finitely many times $0 < a_1 < a_2 < \dots < a_m < 1$ where $S_{a_j}^{i-1} \cap S_{a_j}^{n-i}$ is single point while for $t \neq$ any a_j we have $S_t^{i-1} \cap S_t^{n-i} = \emptyset$. Using the "elementary paths" technique of [3] it is possible to deform ζ_t as above by an isotopy of the intermediate level surfaces so that for t near each a_j the isotopy of S_t^{i-1} past $S_{a_j}^{n-i}$ is as in Diagram 1. For a precise description of this model see [3; Chapt. I. §4]. If the critical points of h_0 are ordered, based, and have oriented stable manifolds then we can read off a sequence of elementary gradient crossings starting from the left $x_{\alpha\beta}(\pm g_1), \dots, x_{\alpha\beta}(\pm g_m)$. If $\varepsilon_1, \dots, \varepsilon_\alpha, \dots, \varepsilon_\beta, \dots, \varepsilon_r$ is a basis for $H_1(\tilde{V}, \tilde{C})$ provided by the stable manifolds of ζ_0 , then the stable manifolds of ζ_1 give the basis $\varepsilon_1, \dots, \varepsilon_\alpha + \lambda \varepsilon_\beta, \dots, \varepsilon_\beta, \dots, \varepsilon_r$ where $\lambda = \pm g_1 \pm g_2 \pm \dots \pm g_m$. Furthermore, under the hypothesis of (1.1) we have

$$(\zeta_t, h_t) = x_{\alpha\beta}^\lambda \cdot (\zeta_0, h_0).$$

Proof of Theorem 1.1.

First we define a map

$$\Delta: \text{St}(r, Z[\pi_1 V]) \rightarrow \pi_1(\mathcal{L}, \mathcal{S}; (\eta_0, f_0)).$$

Let $z \in \text{St}(r, Z[\pi_1 V])$ be represented by the word $\prod_{j=m}^1 z_j$ where each z_j is of the form $x_{\alpha_j \beta_j}(\lambda_j)$ for $\lambda_j \in Z[\pi_1 V]$. (The word $\prod_{j=m}^1 z_j$ is to be read from right to left.) Define

$$(1.3) \quad \Delta(z) = z \cdot (\eta_0, f_0) = z_m \cdot (z_{m-1} \cdots (z_1 \cdot (\eta_0, f_0))).$$

To show that $\Delta(z)$ depends only on z and not on its product representation it suffices to show how each of the Steinberg relations can be realized geometrically. Let $(\zeta, h) \in \cdot$.

$$(1) \quad x_{\alpha\beta}(\lambda) \cdot x_{\alpha\beta}(\mu) \cdot (\zeta, h) = x_{\alpha\beta}(\lambda + \mu) \cdot (\zeta, h).$$

This is an easy consequence of Lemma 1.2'(a).

$$(2) \quad x_{rs}(\lambda) \cdot x_{kl}(\mu) \cdot (\zeta, h) = x_{kl}(\mu) \cdot x_{rs}(\lambda) \cdot (\zeta, h)$$

for $r \neq l$ and $s \neq k$. This follows by an argument quite similar to that in Lemma 1.2'(b).

$$(3) \quad x_{rs}(\lambda) \cdot x_{sl}(\mu) \cdot (\zeta, h) = x_{sl}(\mu) \cdot x_{rl}(\lambda\mu) \cdot x_{rs}(\lambda) \cdot (\zeta, h).$$

GEOMETRY OF THE STEINBERG GROUP

This is the most interesting relation geometrically. Note that by (1) and (2) above the form of the third Steinberg relation as given in (3) is equivalent to the usual form $[x_{rs}(\lambda), x_{sl}(\mu)] = x_{rl}(\lambda\mu)$. Also in view of (1) and (2) it suffices to prove (3) when $\lambda, \mu \in \pm\pi_1 V$. The change in the graphic will be

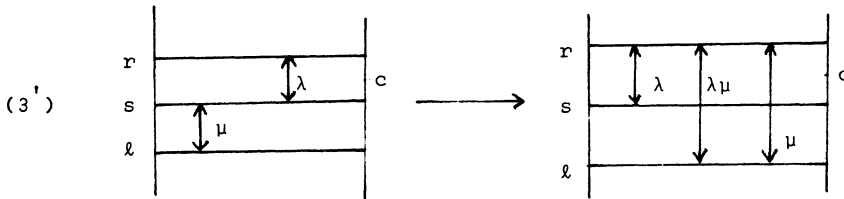

Now consider any elementary i/i -crossing path (ζ_t, h_t) starting at $(\zeta, h) \in$ which passes the i -handle (i.e. stable manifold) for the critical point p_t transversely over the i -handle for the critical point q_t at time $t = a$ as in the diagram

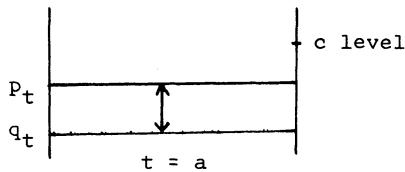

Let $S_t^{n-i} = W^*(p_t) \cap h_t^{-1}(c)$ and $Q_t^{n-i} = W^*(q_t) \cap h_t^{-1}(c)$. For $t \neq a$, Q_t^{n-i} is an $(n-i)$ -sphere as usual; however, for $t = a$, Q_a^{n-i} is an open $(n-i)$ -disc whose closure in $h_a^{-1}(c)$ is a closed

(n-i)-disc that intersects S_a^{n-i} in an (n-i-1)-sphere S_a^{n-i-1} . The local model for the singularity in Q_t as t passes through time a is described in the following diagram:

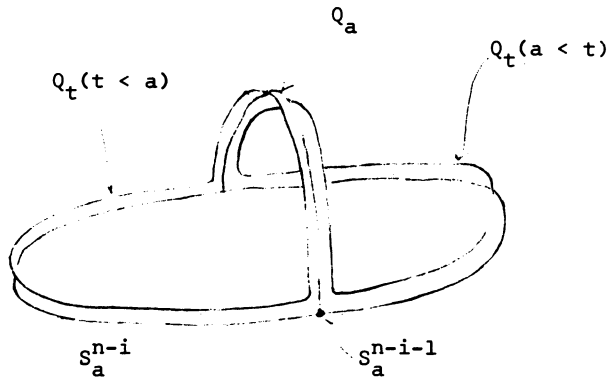

Now consider a path (ζ_t, h_t) as in (3') representing $x_{rs}(\lambda) \cdot x_{sl}(\mu) \cdot (\zeta, h)$. Let $S_t^{n-i} = W^*(p_s(t)) \cap h_t^{-1}(c)$, $Q_t^{n-i} = W^*(p_l(t)) \cap h_t^{-1}(c)$, and $S_t^{i-1} = W(p_r(t)) \cap h_t^{-1}(c)$. Then the following diagram illustrates what happens in $h_t^{-1}(c)$ as t increases. The dotted line shows how to deform S_t^{i-1} to produce the path corresponding to $x_{sl}(\mu) \cdot x_{rl}(\lambda) \cdot x_{rs}(\lambda)$

GEOMETRY OF THE STEINBERG GROUP

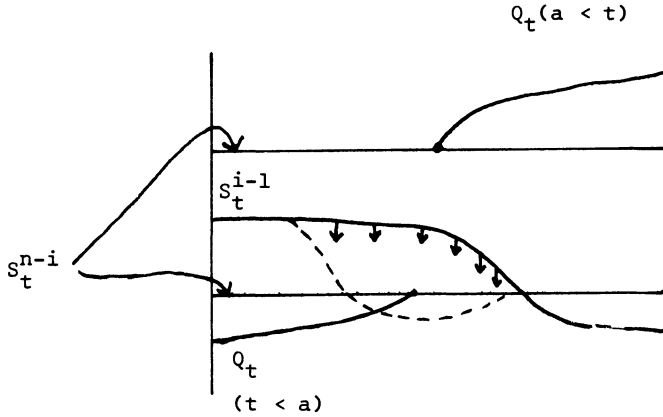

This completes the proof that Δ is well-defined.

To prove that Δ is a bijection we will show that any path (η_t, f_t) in \mathcal{A} which starts at (η_0, f_0) and ends in \mathcal{B} determines a well-defined element

$$\chi(\eta_t, f_t) \in \text{St}(r, Z[\pi_1 V]).$$

The construction of $\chi(\eta_t, f_t)$ will show that the map

$$\chi: \pi_1(\mathcal{A}, \mathcal{B}; (\eta_0, f_0)) \rightarrow \text{St}(r, Z[\pi_1 V])$$

is the inverse of the map Δ .

Put the path (η_t, f_t) into general position keeping (η_0, f_0) fixed and (η_1, f_1) in \mathcal{B} so that there are only finitely many gradient crossings and crossings (i.e. $\begin{matrix} i \\ \diagdown \\ \diagup \\ i \end{matrix}$) which all occur at different times. Thus there are no gradient crossings at a time t

where $f_t \in \mathcal{F}_\beta^1$. Now reading from left to right across the graphic produces a sequence $x_{\alpha_1 \beta_1}(\lambda_1), \dots, x_{\alpha_m \beta_m}(\lambda_m)$ of gradient crossings as in Addendum 2 above. We define

$$(1.4) \quad \chi(\eta_t, f_t) = \prod_{j=1}^m x_{\alpha_j \beta_j}(\lambda_j).$$

It must be shown that the word $\chi(\eta_t, f_t)$ is not changed when considered as an element of $\text{St}(r, Z[\pi_1 V])$ under a deformation of (η_t, f_t) which fixes (η_0, f_0) and moves (η_1, f_1) in β' .

Let $(\alpha(t,s), g(t,s))$ be a two parameter family in \mathcal{C} such that for all s

$$(\alpha(0,s), g(0,s)) = (\eta_0, f_0) \text{ and } (\alpha(1,s), g(1,s)) \in \beta'.$$

For each fixed $0 \leq s \leq 1$ let $\gamma_s = (\alpha(t,s), g(t,s))$ for $0 \leq t \leq 1$. Suppose that paths γ_0 and γ_1 are in general position with only finitely many crossings and i/i -intersections which all occur at different times. We shall show that $\chi(\gamma_0) = \chi(\gamma_1)$ in $\text{St}(r, Z[\pi_1 V])$.

It is possible to deform the two parameter family into general position (keeping things fixed for $t = 0$ or $s = 0, 1$ and keeping the $t = 1$ end point of each γ_s in β') so that the following conditions are satisfied:

- (1) For $0 \leq i \leq 2$ let $\Pi_i \subset I \times I$ consist of those parameters (t,s) at which $g(t,s) \in \mathcal{F}_i^1$. Then Π_2 is a finite set of points, Π_1 is a collection of finitely many disjoint circles and arcs

GEOMETRY OF THE STEINBERG GROUP

between points of Π_2 , and $\Pi_0 = I \times I - \Pi_1 - \Pi_2$.

- (2) There are two mutually disjoint sequences $0 < s_1 < \dots < s_a < 1$ and $0 < s'_1 < \dots < s'_b < 1$ such that for $s \neq s_i$ or s'_j the gradient crossings of γ_s are transverse and occur at different times. Furthermore, we have

- (a) If $s = s_i$, then there is exactly one time t_i at which the path γ_{s_i} has a non-transverse i/i -intersection. The other i/i -intersections of γ_{s_i} are at distinct times. In the level surfaces near the non-transverse intersection the deformation of S_t^{i-1} and S_t^{n-i} looks like

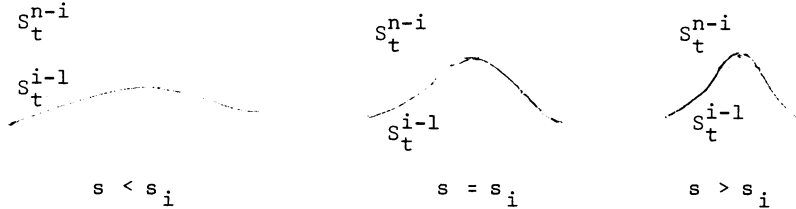

or its reverse.

- (b) If $s = s'_j$ then there is exactly one time t'_j at which two transverse i/i -intersections occur simultaneously for the path $\gamma_{s'_j}$. All the other i/i -intersections of $\gamma_{s'_j}$ occur at distinct times.
- (3) Finally, all the exceptional parameters (t_i, s_i) and (t'_j, s'_j) lie in Π_0 .

Now for $s \neq s_i$ or s_j the word $\chi(\gamma_s)$ is locally constant. Hence we must see what happens to $\chi(\gamma_s)$ when $s = s_i$ and when $s = s_j$.

Case (a). Let $s = s_i$ and let p_k and p_l be the critical points between which the non-transverse gradient crossing occurs at the parameter (t_i, s_i) . The local change in the graphic is

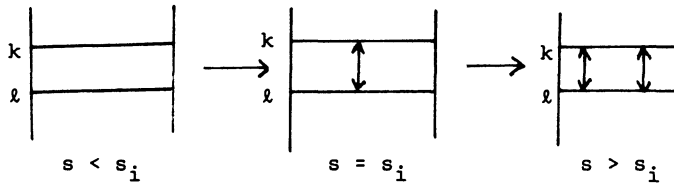

or its reverse. The corresponding change from $\chi(\gamma_{s_i - \epsilon})$ to $\chi(\gamma_{s_i + \epsilon})$ is to insert or delete a subword of the form $x_{kl}(\pm g) \cdot x_{kl}(\mp g)$. By the first Steinberg relation we know therefore that χ is not changed.

Case (b). When $s = s_j$ there are two possibilities corresponding to the second and third Steinberg relations. Let $x_{\alpha\beta}(\lambda)$ and $x_{kl}(\mu)$ be the Steinberg generators for the two transverse gradient crossings of $W(p_\alpha(t))$ past $W^*(p_\beta(t))$ and of $W(p_k(t))$ past $W^*(p_l(t))$ which occur at the same time $t = t_j$. Here $\lambda, \mu \in (\pm\pi_1 V)$.

GEOMETRY OF THE STEINBERG GROUP

Subcase 1. $\alpha \neq \ell$ and $\beta \neq k$.

(i) if α, β, ℓ , and k are distinct the change in the graphic is

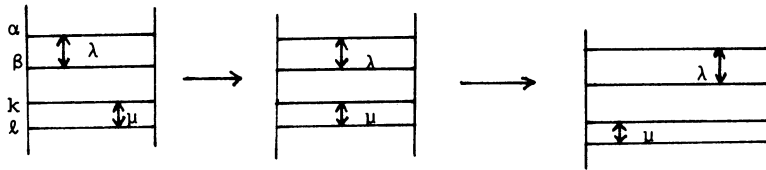

or

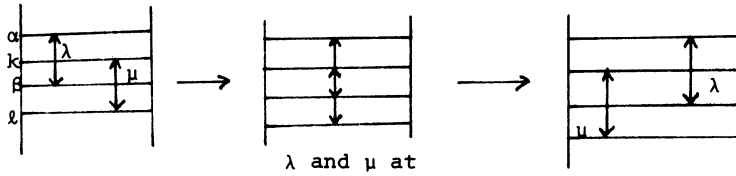

λ and μ at
same time

or

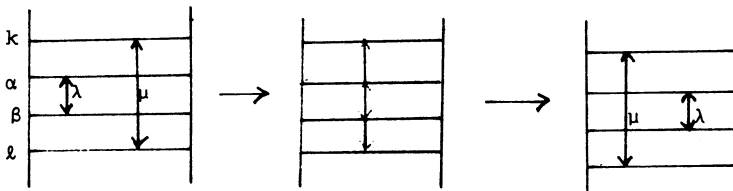

λ and μ at
same time

(ii) If $\beta = \ell$, the change in graphic is

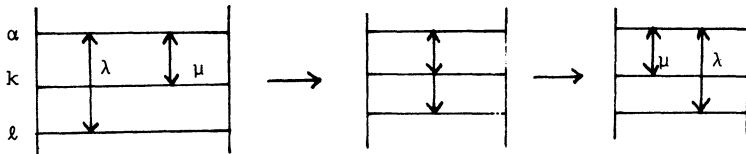

or

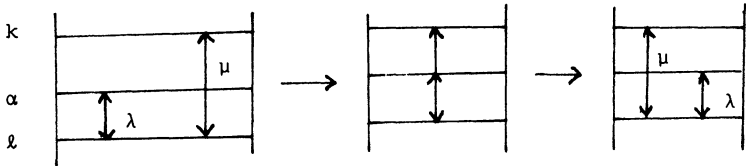

(iii) If $\alpha = k$ and $\beta = l$, the change in graphic is

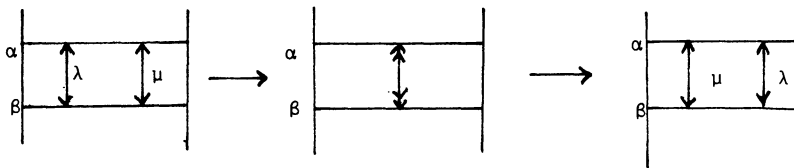

λ and μ

at same time

In each case the effect is to replace the word $x_{k\ell}(\mu) \cdot x_{\alpha\beta}(\lambda)$ by the word $x_{\alpha\beta}(\lambda) \cdot x_{k\ell}(\mu)$. Hence $\chi(\gamma_S)$ doesn't change in $\text{St}(r, Z[\pi_1 V])$ by the second Steinberg relation.

Subcase 2. $\beta = k$ but $\alpha \neq \ell$. The change in the graphic will be

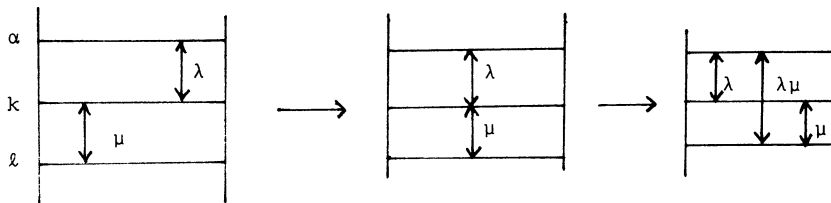

or

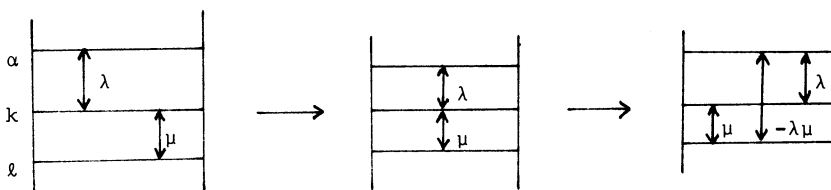

Compare with (3') above.

The effect on χ is to replace $x_{\alpha k}(\lambda) \cdot x_{k\ell}(\mu)$ by $x_{k\ell}(\mu) \cdot x_{\alpha\ell}(\lambda\mu) \cdot x_{\alpha k}(\lambda)$ or to replace $x_{k\ell}(\mu) \cdot x_{\alpha k}(\lambda)$ by $x_{\alpha k}(\lambda) \cdot x_{\alpha\ell}(-\lambda\mu) \cdot x_{k\ell}(\mu)$. Hence χ doesn't change in $\text{St}(r, Z[\pi_1 V])$ by the second and third Steinberg relations.

This completes the proof of Theorem 1.1.

§2. Multi-level Steinberg words.

Suppose (η, f) is a nice pair in $\hat{\mathcal{F}}$ such that $f: (V; C, D) \rightarrow (I; 0, 1)$ is an ordered function and has only non-degenerate critical points. Let $0 < r_0 < r_1 < \dots < r_n < 1$ be chosen so that

- (*) if p is a critical point of f of index i
 then $r_{i-1} < f(p) < r_i$.

Let $(V_i; \partial_- V_i, \partial_+ V_i) = (f^{-1}([r_{i-1}, r_i]); f^{-1}(r_{i-1}), f^{-1}(r_i))$. Let $p: \tilde{V} \rightarrow V$ be the universal cover of V and for any subset $A \subset V$ let $\tilde{A} = p^{-1}(A)$. Choose paths from each critical point to a fixed base point in V and orient the stable manifold of each critical point. This data determines as in [17] a based chain complex $(C_*, \partial_*(\eta, f))$ where each chain group $C_i = H_i(\tilde{V}_i, \partial_- \tilde{V}_i)$ is free over $Z[\pi_1 V]$ with one generator for each critical point of f of index i . Furthermore $H_*(\tilde{V}, \tilde{C}) \cong H_*(C_*)$.

Now suppose (η_t, f_t) is a path in general position such that f_t satisfies (*) for all t . The matrices $\partial_i(\eta_t, f_t): C_i \rightarrow C_{i-1}$ will in general vary by left and right multiplication by elementary matrices as t varies. More precisely, the procedure of §1 above gives rise to a sequence of Steinberg words

$$\chi = \chi(\eta_t, f_t) = (\chi_0(\eta_t, f_t), \chi_1(\eta_t, f_t), \dots)$$

where $\chi_i(\eta_t, f_t) = \chi_i$ lies in $St_i(Z[\pi_1 V])$, the Steinberg group generated by symbols $x_{pq}(\lambda)$ where p and q run through the

indexing set consisting of the critical points of f_0 of index i . (Compare §1 of III below.) Let $E_i(Z[\pi_1 V])$ denote the corresponding group of elementary matrices and let $\hat{\chi}_i \in E_i(Z[\pi_1 V])$ denote the image of χ_i under the homomorphism $St_i(Z[\pi_1 V]) \rightarrow E_i(Z[\pi_1 V])$. Then it follows from Lemma 1.2 above that

$$(2.1) \quad \partial_i(\eta_1, f_1) = \hat{\chi}_i \cdot \partial_i(\eta_0, f_0) \cdot \hat{\chi}_{i-1}^{-1} \quad .$$

To define the invariant $\Sigma: \pi_0(\mathcal{P}) \rightarrow Wh_2$ we must study how $\chi(\eta_t, f_t)$ changes as the path (η_t, f_t) is deformed.

Suppose γ_s is a deformation of $\gamma_0 = (\eta_t, f_t)$ to $\gamma_1 = (\zeta_t, h_t)$ where both γ_0 and γ_1 satisfy the one parameter ordering theorem (8.1). Then the deformation γ_s can be taken to satisfy the two parameter ordering theorem (8.2). By suspending this situation as in §5 of I we can assume that the indices of critical points are not too low or too high and hence that the birth and death points are independent except in a very small neighborhood of the dovetail singularities.

Important Remark 2.2. The work of §1 of this chapter implies that

$$\chi(\gamma_s) \in \bigoplus_i St_i(Z[\pi_1(M \times I)])$$

doesn't change unless one of the three changes described in the table below takes place. So that the information will be in one convenient place we have included the changes in the gradient crossings also. Why these take place will be discussed in Chapter IV

where we construct $\Sigma: \pi_0(\mathcal{P}) \rightarrow Wh_2$ and show it is well-defined.

Table 2.3.

Exchange relation

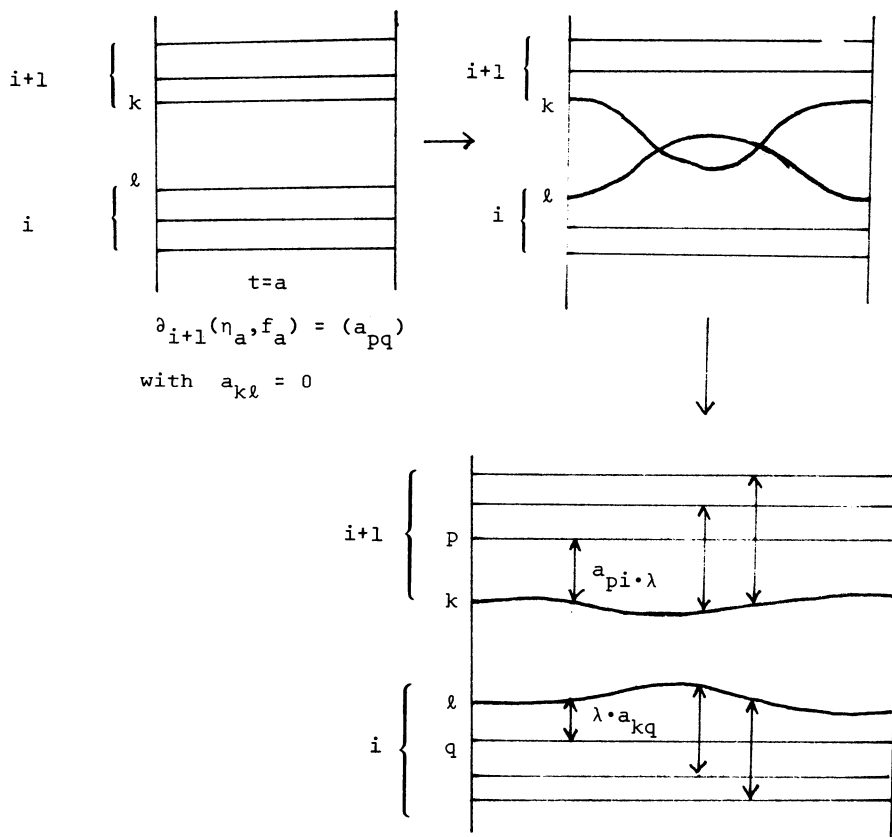

Birth-Death Relations

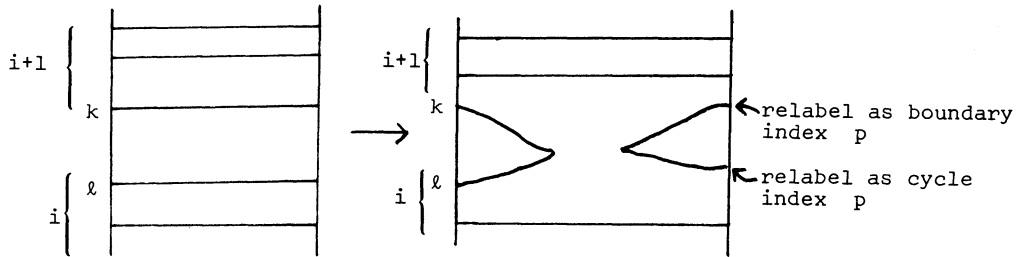

or

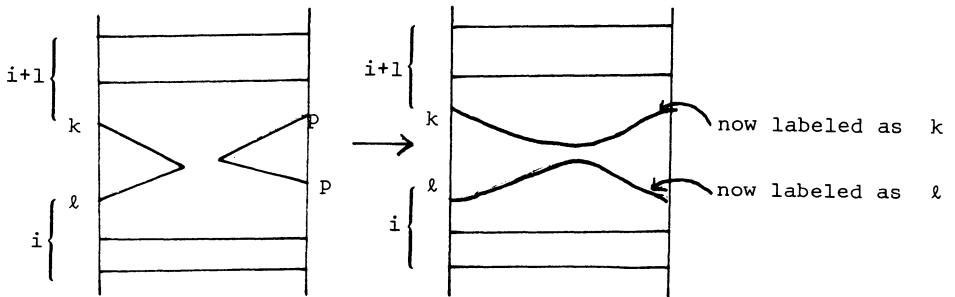

Dovetail relation

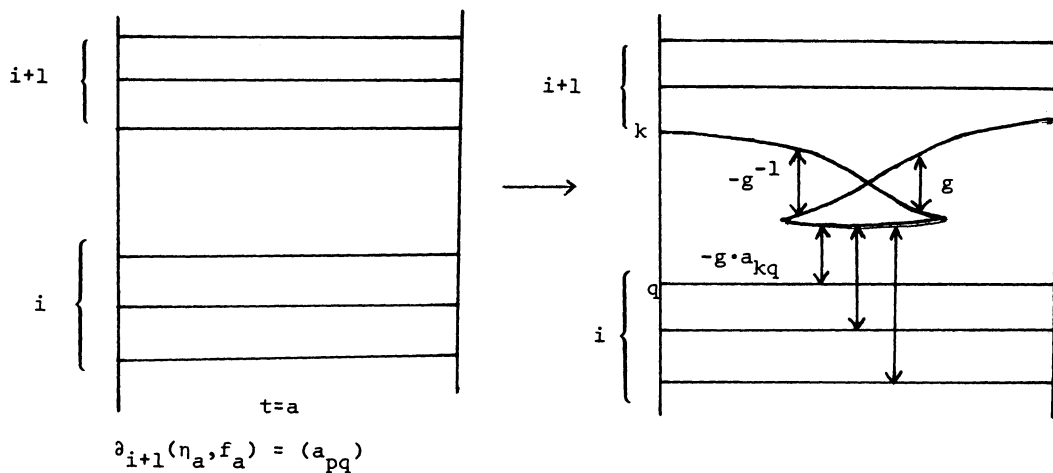

or

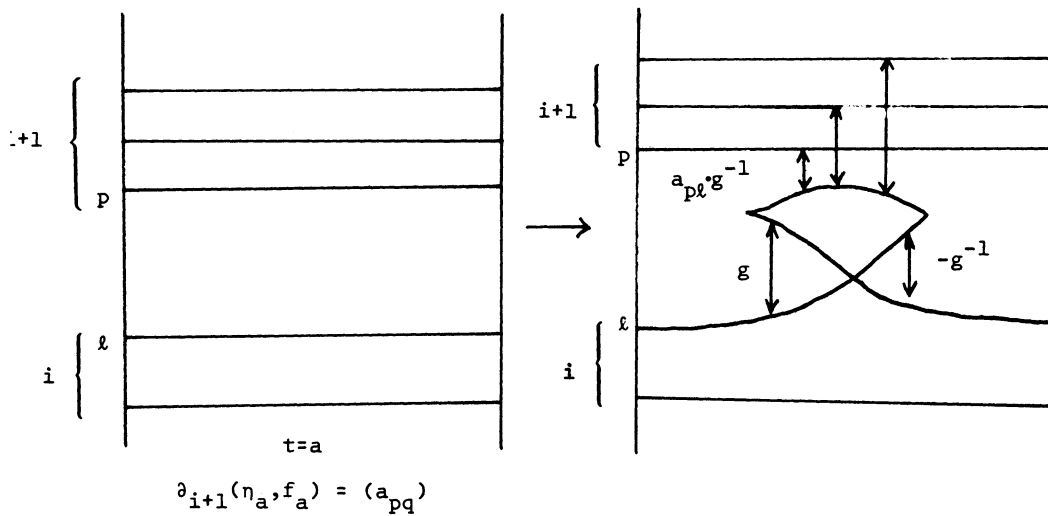

CHAPTER III. More about Wh₂.

In this chapter we discuss the algebra needed to define
 $\Sigma: \pi_0(\mathcal{C}) \rightarrow Wh_2$.

§1. Presentations of Wh₂.

Let Λ be any associative ring with identity and let Γ be any countable indexing set. Let $St(\Lambda)$ denote the Steinberg group formed using the indexing set Γ : i.e., $St(\Lambda)$ is the free group on the symbols $x_{pq}(\lambda)$ (where $p, q \in \Gamma$ and $\lambda \in \Lambda$) modulo the usual Steinberg relations (see the Introduction). Let $E(\Lambda)$ denote the corresponding group of elementary matrices and define $K_2(\Lambda)$ by the exact sequence

$$(1.1) \quad 1 \rightarrow K_2(\Lambda) \rightarrow St(\Lambda) \xrightarrow{\pi} E(\Lambda) \rightarrow 1$$

Suppose $\Lambda = Z[G]$ for some group G . Let $W(\Lambda) \subset St(\Lambda)$ denote the subgroup of those elements $x \in St(\Lambda)$ such that $\pi(x) = P \cdot D$ where P is a finite permutation matrix and D is the identity matrix except for at most finitely many diagonal entries of the form $\pm g$ for $g \in G$. Let $W(\pm G) \subset W(\Lambda)$ denote the subgroup generated by words $w_{pq}(\pm g)$ of the form $x_{pq}(\pm g)x_{qp}(\mp g^{-1})x_{pq}(\pm g)$. Let $H(\Lambda) \subset W(\Lambda)$ denote the subgroup of those elements x such that $\pi(x) = D$ where D is a diagonal matrix as above. Let $H(\pm G) \subset H(\Lambda)$ denote the subgroup generated by the words $h_{pq}(\pm g) = w_{pq}(\pm g) \cdot w_{pq}(-1)$.

Let $W_0(\pm G) = W(\pm G) \cap K_2(\mathbb{Z}[G])$ and define

$$(1.2) \quad Wh_2(G) = K_2(\mathbb{Z}[G]) \text{ mod } W_0(\pm G).$$

This definition is actually independent up to canonical isomorphism of the choice of the countable indexing set Γ . For if Γ' is any other such indexing set let $\beta: \Gamma \rightarrow \Gamma'$ be a bijection. Then the correspondence $x_{pq}(\lambda) \rightarrow x_{\beta(p), \beta(q)}(\lambda)$ induces an isomorphism from the St and K_2 formed from Γ to St and K_2 formed from Γ' . Since K_2 is the center of St (see [19, §5]), this isomorphism is independent of the choice of β by Corollary 9.4 of [19]. The induced isomorphism between the Wh_2 's is therefore also independent of the choice of β .

From now on we will take $\Gamma = \{(i, j) \mid 0 \leq i, j < \infty\}$. Linearly order Γ by saying that $(i, j) < (k, \ell)$ iff either $i < k$ or $i = k$ and $j < \ell$.

Let $U(\Lambda) \subset St(\Lambda)$ denote the subgroup consisting of those x such that if $\pi(x) = (a_{pq})$, $p, q \in \Gamma$, then

$$(a) \quad a_{pq} = 0 \quad \text{whenever } q < p, \text{ and}$$

$$(b) \quad a_{pp} = \pm g_p \quad \text{for some } g_p \in G.$$

Let $T \subset U(\Lambda)$ denote the subgroup generated by $x_{pq}(\lambda)$ where $p < q$. Let $U(\pm G)$ denote the subgroup of $U(\Lambda)$ generated by the elements of $H(\pm G)$ and T .

MORE ABOUT Wh_2

Lemma 1.3. Every element of $U(\pm G)$ can be represented uniquely as a product $h \cdot t$ where $h \in H(\pm G)$ and $t \in T$.

Proof of 1.3. Suppose $h_1 \cdot t_1 = h_2 \cdot t_2$ in $St(\Lambda)$ where $h_i \in H(\pm G)$ and $t_i \in T$. Then $h_2^{-1} \cdot h_1 = t_2 \cdot t_1^{-1}$ and hence $\pi(h_2^{-1} \cdot h_1) = \pi(t_2 \cdot t_1^{-1})$. Since the right hand side is in $\pi(T)$ and the left hand side is in $\pi(H(\pm G))$ we must have $\pi(t_2 \cdot t_1^{-1}) = 1$. Therefore $t_1 = t_2$ in T because $\pi: T \rightarrow E(\Lambda)$ is a monomorphism. See [19, 5.2]. Hence $h_1 = h_2$.

It will be useful to describe $Wh_2(G)$ several ways as a quotient $A \text{ mod } B$ where A and B are subgroups of $St(\Lambda)$. Recall the sequence

$$1 \rightarrow K_2(\Lambda) \rightarrow St(\Lambda) \xrightarrow{\pi} E(\Lambda) \rightarrow 1 .$$

Consider a subgroup F of $E(\Lambda)$. Let $A = \pi^{-1}(F)$ and let $B \subset A$ be a subgroup such that $\pi(B) = F$. Let $x \in A$. Define $(x) \in K_2(\Lambda)/K_2(\Lambda) \cap B$ by

$$(1.4) \quad (x) = x \cdot b^{-1} \text{ mod } K_2(\Lambda) \cap B$$

where $b \in B$ is any element with $\pi(x) = \pi(b)$.

Lemma 1.5. The element (x) is independent of the choice of b and gives an exact sequence

$$1 \rightarrow B \rightarrow A \rightarrow K_2(\Lambda) \text{ mod } K_2(\Lambda) \cap B \rightarrow 1 .$$

The proof is easy.

The construction (1.4) is natural in the following sense: Suppose that $F' \subset F$. Let $A' = \pi^{-1}(F')$ and let $B' \subset A'$ be a subgroup such that $B' \subset B$ and $\pi(B') = F'$. Then there is a commutative diagram

$$\begin{array}{ccccccc} 1 & \rightarrow & B' & \rightarrow & A' & \rightarrow & K_2(\Lambda) \text{ mod } K_2(\Lambda) \cap B' \rightarrow 1 \\ & & \downarrow & & \downarrow & & \\ 1 & \rightarrow & B & \rightarrow & A & \rightarrow & K_2(\Lambda) \text{ mod } K_2(\Lambda) \cap B \rightarrow 1 \end{array}$$

This construction will be used in three cases

- (1) $A = W(\Lambda)$, $B = W(\pm G)$, $F = \pi(W(\Lambda))$
- (2) $A = H(\Lambda)$, $B = H(\pm G)$, $F = \pi(H(\Lambda))$
- (3) $A = U(\Lambda)$, $B = U(\pm G)$, $F = \pi(U(\Lambda))$.

Lemma 1.6. In each of the three above cases the condition $\pi(A) = \pi(B)$ is satisfied; furthermore, in each case we have

$$K_2(\Lambda) \cap B = K_2(\Lambda) \cap H(\pm G).$$

The proof of the second part of (1.6) is entirely similar to the argument showing Th. 9.11 in [19]. We leave it as an exercise. Also, we shall just prove that $\pi(A) = \pi(B)$ in the case $A = W(\Lambda)$ and $B = W(\pm G)$ and leave the other cases to the reader:

Let $x \in W(\Lambda)$ and let $M = \pi(x)$. Then $M = P \cdot D$ where, for some large integer r , P is an $r \times r$ permutation matrix times a

The naturality of (1.4) gives the following commutative diagram:

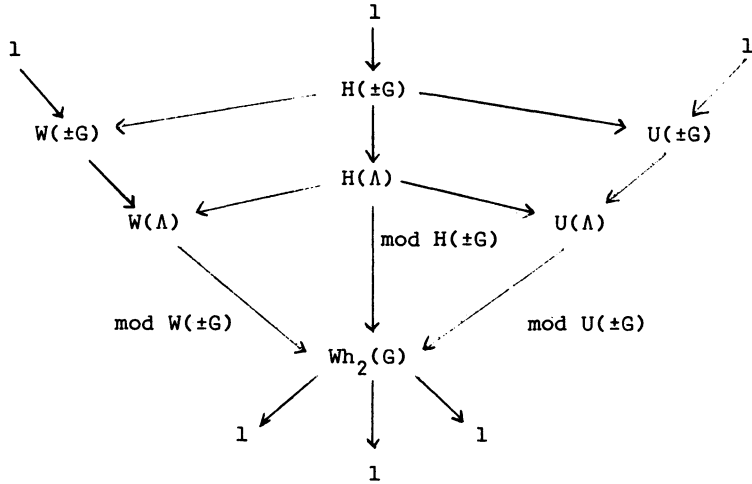

Diagram 1.7.

In what follows we shall sometimes denote $\pi(G)$ by \hat{G} for any subgroup G of $St(\Lambda)$.

§2. Relations in the Steinberg group.

For simplicity we use the indexing set $\Gamma = \{1,2,3,\dots\}$ with the usual linear ordering to form $St(\Lambda)$ in this section. The lemmas below translate easily to statements about $St(\Lambda)$ formed from the indexing set $\Gamma = \{(i,j) | 1 \leq i, j < \infty\}$.

Exchange relation. Let $x \in St(n, \Lambda)$ and let $A = (a_{ij}) = \pi(x) \in E(n, \Lambda)$. Suppose $n \geq 3$ and that $a_{k\ell} = 0$ for some pair (k, ℓ) with $1 \leq k, \ell \leq n$. Then

$$(2.1) \quad \left(\prod_{i \neq k} a_{ik}^{a_{i\ell} \cdot \lambda} \right) \cdot x = x \cdot \left(\prod_{j \neq \ell} x_{\ell j}^{\lambda \cdot a_{kj}} \right)$$

in $St(m, \Lambda)$ where $m > n$ and λ is any element of Λ .

Proof of exchange. The third Steinberg relation implies that

$$(a) \quad \prod_{i \neq k} a_{ik}^{a_{i\ell} \cdot \lambda} = \prod_{i \neq k} \left[x_{im}^{a_{i\ell} \cdot \lambda}, x_{mk}^1 \right] \quad \text{and}$$

$$(b) \quad \prod_{j \neq \ell} x_{\ell j}^{\lambda \cdot a_{kj}} = \prod_{j \neq \ell} \left[x_{\ell m}^\lambda, x_{mj}^{a_{kj}} \right].$$

Let $[a, b] = aba^{-1}b^{-1}$ and recall the commutator identities

$$\begin{aligned} [a, b] &= [b, a]^{-1} \\ [a, b \cdot c] &= [a, b] \cdot [a, c] \cdot [[c, a], b]. \end{aligned}$$

Together with the Steinberg relations they imply that

$$(c) \quad \prod_{i \neq k} \left[x_{im}^{a_{il} \cdot \lambda}, x_{mk}^1 \right] = \left[\prod_{i \neq k} x_{im}^{a_{il} \cdot \lambda}, x_{mk}^1 \right] \text{ and}$$

$$(d) \quad \prod_{j \neq k} \left[x_{\ell m}^\lambda, x_{mj}^{a_{kj}} \right] = \left[x_{\ell m}^\lambda, \prod_{j \neq \ell} x_{mj}^{a_{kj}} \right].$$

$$\text{Set } \alpha = \prod_{i \neq k} x_{im}^{a_{il} \cdot \lambda} \text{ and } \beta = \prod_{j \neq \ell} x_{mj}^{a_{kj}}.$$

Then from (c) and (d) we must show that

$$(e) \quad x^{-1} \cdot [\alpha, x_{mk}^1] \cdot x = [x_{\ell m}^\lambda, \beta] \text{ in } \text{St}(r, \Lambda).$$

The left hand side of (e) is equal to

$$[x^{-1} \cdot \alpha \cdot x, x^{-1} \cdot x_{mk}^1 \cdot x].$$

Hence to prove (e) we must show that

$$(f) \quad x^{-1} \cdot \alpha \cdot x = x_{\ell m}^\lambda \text{ and}$$

$$(g) \quad x^{-1} \cdot x_{mk}^1 \cdot x = \beta.$$

Let $C_m \subset \text{St}(m, \Lambda)$ and $R_m \subset \text{St}(m, \Lambda)$ denote the subgroups generated by symbols x_{im}^λ and x_{mi}^λ respectively. These subgroups

MORE ABOUT WH_2

map monomorphically under π to $E(m, \Lambda)$. (*) The second and third Steinberg relations show that

$$x^{-1} \cdot \alpha \cdot x \in C_m \quad \text{and} \quad x^{-1} \cdot x_{mk}^1 \cdot x \in R_m.$$

Hence to verify (f) and (g) it suffices to check these identities on the matrix level; i.e., in $E(m, \Lambda)$:

$$(h) \quad \begin{pmatrix} A^{-1} & 0 \\ 0 & 1 \end{pmatrix} \prod_{i \neq k} e_{im}^{a_{il} \cdot \lambda} \begin{pmatrix} A & 0 \\ 0 & 1 \end{pmatrix} = e_{lm}^\lambda$$

$$(i) \quad \begin{pmatrix} A^{-1} & 0 \\ 0 & 1 \end{pmatrix} \cdot e_{mk}^1 \cdot \begin{pmatrix} A & 0 \\ 0 & 1 \end{pmatrix} = \prod_{j \neq l} e_{mj}^{a_{kj}}$$

These are straightforward computations once we recall that $a_{k\ell} = 0$; because then

$$\prod_{i \neq k} e_{im}^{a_{il} \cdot \lambda} = \left(\begin{array}{c|c} I & (\ell^{\text{th}} \text{ col of } A) \cdot \lambda \\ \hline 0 & 1 \end{array} \right)$$

and

(*) See [25, p. 205-206].

Dovetail relation. ($n \geq 3$). Let $x \in \text{St}(n, \Lambda)$ and $\pi(x) = (a_{ij}) \in E(n, \Lambda)$.

Let $1 \leq k \leq n$ and let $p > n$. Let $u \in \Lambda^*$ be any unit of Λ .

Then

$$(2.2) \quad x_{pk}(u) \cdot x_{kp}(-u^{-1}) \cdot x \cdot \left(\begin{array}{c} | \\ x_{pj}(u \cdot a_{kj}) \\ | \\ j \neq p \end{array} \right) = w_{pk}(u) \cdot x$$

in $\text{St}(p+1, \Lambda)$.

Proof. Multiplying (2.2) through on the left by $[x_{pk}(u) \cdot x_{kp}(-u)^{-1}]^{-1}$ gives

$$x \cdot \left(\begin{array}{c} u \cdot a_{kj} \\ x_{pj} \\ | \\ j \neq p \end{array} \right) = x_{pk}^u \cdot x$$

which is a special case of the exchange lemma.

Birth and death relation. Let $\Lambda = Z[G]$. Let $x \in \text{St}(n, \Lambda)$ and $A = \pi(x) = (a_{ij}) \in E(n, \Lambda)$. Assume $n \geq 3$. Assume $a_{k\ell} = \pm g$ for $g \in G$ and $1 \leq k, \ell \leq n$ and also assume that $a_{kj} = 0$ for $j \neq k$ and $a_{i\ell} = 0$ for $i \neq \ell$. Let $n < p \leq m$. Then

$$(2.3) \quad w_{kp}(\pm g) \cdot x = x \cdot w_{\ell p}(1)$$

in $\text{St}(m, \Lambda)$.

Proof. It suffices to prove that

$$x^{-1} \cdot w_{kp}(\pm g) \cdot x = w_{lp}(1) .$$

But this follows from

$$(a) \quad x^{-1} \cdot x_{kp}(\pm g) \cdot x = x_{lp}(1)$$

and

$$(b) \quad x^{-1} \cdot x_{pk}(\bar{\tau}g^{-1}) \cdot x = x_{pl}(-1).$$

To see why (a) and (b) hold, note that the second and third Steinberg relations imply that the left hand side of (a) is in

$C_p \subset \text{St}(m, \Lambda)$ and the left hand side of (b) is in $R_p \subset \text{St}(m, \Lambda)$.

Since $x_{lp}(+1) \in C_p$ and $x_{pl}(-1) \in R_p$, it suffices to prove

$$(c) \quad A^{-1} \cdot e_{kp}(\pm g) \cdot A = e_{lp}(1)$$

$$(d) \quad A^{-1} \cdot e_{pk}(\bar{\tau}g^{-1}) \cdot A = e_{pl}(-1)$$

because the groups C_p and R_p map monomorphically into $E(\Lambda)$.

But (c) and (d) are easy matrix computations. q.e.d.

Proposition 2.4. Let $\Lambda = Z[G]$. Let $A \in \text{St}(\Lambda)$ and suppose that for $i = 1, 2$ there are elements $P_i, Q_i \in W(\pm G)$ such that setting $p_i = \pi(P_i)$, $q_i = \pi(Q_i)$, and $a = \pi(A)$ in $E(\Lambda)$ we have

MORE ABOUT WH_2

$P_i \cdot a \cdot Q_i = v_i$ for some $v_i \in \pi(T)$. Then

$$P_1 \cdot A \cdot Q_1 = P_2 \cdot A \cdot Q_2 \quad \text{mod } U(\pm G).$$

First we prove

Lemma. Let $Q \in W(\pm G)$ and $V \in T$. Let $q = \pi(Q)$ and $v = \pi(V)$. Suppose that $q \cdot v \cdot q^{-1} \in \pi(T)$. Then $Q \cdot V \cdot Q^{-1} \in T$.

Proof of lemma. Assume for some large $n > 0$ that $Q, V \in \text{St}(n, Z[G])$. As in [19, p. 72] write $q = \sigma \cdot d$ where σ is an $n \times n$ permutation matrix and d is an $n \times n$ diagonal matrix with entries $\epsilon_1, \dots, \epsilon_n$ of the form $\pm g$ for various g 's in G . Write V in lexicographical order $V = \alpha_{n-1} \dots \alpha_1$ where for $1 \leq k \leq n-1$

$$\alpha_k = \begin{matrix} n \\ | \\ i=k+1 \end{matrix} x_{ki}(\lambda_{ki})$$

Then as in [19, Cor. 9.4]

$$Q \cdot V \cdot Q^{-1} = \beta_{n-1} \dots \beta_1$$

where for $1 \leq k \leq n-1$

$$\beta_k = Q \cdot \alpha_k \cdot Q^{-1} = \begin{matrix} n \\ | \\ i=k+1 \end{matrix} x_{\sigma(k), \sigma(i)}(\epsilon_k \lambda_{ki} \epsilon_i^{-1})$$

Let $\hat{\beta}_k = \pi(\beta_k) \in E(n, Z[G])$. The $\sigma(1)$ th row of $q \cdot v \cdot q^{-1} = \begin{matrix} 1 \\ \vdots \\ i=n-1 \end{matrix} \hat{\beta}_k$

is the $\sigma(1)^{\text{th}}$ row of $\hat{\beta}_1$, because, for $i > 1$ $\hat{\beta}_i$ is a product of symbols $x_{\sigma(i)\sigma(j)}(\epsilon_i \lambda_{ij} \epsilon_j^{-1})$ where $\sigma(i) \neq \sigma(j)$; that is, the elementary matrices $e_{\sigma(i)\sigma(j)}(\epsilon_i \lambda_{ij} \epsilon_j^{-1})$ for $i > 1$ do not add anything to the $\sigma(1)^{\text{th}}$ row. Since $q \cdot v \cdot q^{-1} \in \pi(T)$ we conclude that $\epsilon_i \lambda_{ij} \epsilon_j^{-1} = 0$ whenever $\sigma(1) > \sigma(j)$ and thus $\beta_1 \in T$. This implies $\hat{\beta}_{n-1} \cdot \dots \cdot \hat{\beta}_2 \in \pi(T)$ and we can proceed to show as above that $\beta_2 \in T$. Continue in this way to show that all $\beta_i \in T$ and therefore $Q \cdot V \cdot Q^{-1} \in T$.

Proof of 2.4. First note that $v_2 = (q_2^{-1} \cdot q_1) \cdot v_1 \cdot (q_1^{-1} \cdot q_2)$: from hypothesis we know $a = p_1^{-1} \cdot v_1 \cdot q_1^{-1} = p_2^{-1} \cdot v_2 \cdot q_2^{-1}$ and hence

$$v_2 = p_2 p_1^{-1} v_1 q_1^{-1} q_2 = (p_2 p_1^{-1})(q_1^{-1} q_2)(q_1^{-1} q_2)^{-1} v_1 (q_1^{-1} q_2).$$

Since $v_i \in \pi(T)$ we have $(p_2 p_1^{-1})(q_1^{-1} q_2) = 1$.

It then follows from the lemma above that $(Q_2^{-1} \cdot Q_1) \cdot v_1 \cdot (Q_1^{-1} \cdot Q_2) \in T$ and hence

$$(Q_2^{-1} \cdot Q_1) \cdot v_1 \cdot (Q_1^{-1} \cdot Q_2) = v_2$$

or

$$Q_1 \cdot v_1^{-1} \cdot Q_1^{-1} = Q_2 \cdot v_2^{-1} \cdot Q_2^{-1}.$$

Here V_i is the lifting of v_i to T for $i = 1, 2$.

Now commutativity of Diagram 1.7 shows that

MORE ABOUT WH_2

$$\begin{aligned} P_1 \cdot A \cdot Q_1 \pmod{U(\pm G)} &= P_1 \cdot A_1 \cdot Q_1 \cdot V_1^{-1} \pmod{H(\pm G)} \\ &= A \cdot Q_1 \cdot V_1^{-1} \pmod{W(\pm G)} \\ &= A \cdot Q_1 \cdot V_1^{-1} \cdot Q_1^{-1} \pmod{W(\pm G)} \\ &= A \cdot Q_2 \cdot V_2^{-1} \cdot Q_2^{-1} \pmod{W(\pm G)} \\ &= A \cdot Q_2 \cdot V_2^{-1} \pmod{W(\pm G)} \\ &= P_2 \cdot A \cdot Q_2 \cdot V_2^{-1} \pmod{H(\pm G)} \\ &= P_2 \cdot A \cdot Q_2 \pmod{U(\pm G)} \end{aligned}$$

§3. Construction of $\Sigma: \Omega \rightarrow Wh_2$.

This section gives the first step in the construction of $\Sigma: \pi_0(\mathcal{P}(M, \partial M)) \rightarrow Wh_2(\pi_1 M)$.

Let C_0 be the free, left Λ -module based on $\{z_0^\alpha\}$ where $0 \leq \alpha < \infty$. For $1 \leq i < \infty$ let C_i be the free, left Λ -module based on $\{b_i^\alpha, z_i^\alpha\}$ where $0 \leq \alpha < \infty$. Then $C_i = B_i \oplus Z_i$ where B_i and Z_i are the free Λ -submodules of C_i based on $\{b_i^\alpha\}$ and $\{z_i^\alpha\}$ respectively. Let $St_i(\Lambda)$ be the Steinberg group formed from the indexing set $\Gamma = \{b_i^\alpha, z_i^\alpha\}$ or $\Gamma = \{z_i^\alpha\}$ when $i = 0$. Thus $St_i(\Lambda)$ is generated by symbols $x_{pq}(\lambda)$ where $p =$ some b_i^α or z_i^α and $q =$ some b_i^α or z_i^α . The b_i^α and z_i^α will be called respectively the boundary indices and the cycle indices in dimension i .

We shall say that b_i^α and z_{i-1}^α are corresponding indices.

Let $E_i(\Lambda)$ be the group of Λ -automorphisms of C_i generated by the elementary matrices $e_{pq}(\lambda)$ and let $\pi_i: St_i(\Lambda) \rightarrow E_i(\Lambda)$ be the homomorphism which sends $x_{pq}(\lambda)$ to $e_{pq}(\lambda)$. Define

$$St_C(\Lambda) = \bigoplus_{0 \leq i} St_i(\Lambda)$$

$$St_{ev}(\Lambda) = \bigoplus_{i=\text{even}} St_i(\Lambda)$$

$$St_{odd}(\Lambda) = \bigoplus_{i=\text{odd}} St_i(\Lambda)$$

Similarly, let

MORE ABOUT WH_2

$$E_C(\Lambda) = \bigoplus_{0 \leq i} E_i(\Lambda)$$

$$E_{ev}(\Lambda) = \bigoplus_{i=\text{even}} E_i(\Lambda)$$

$$E_{odd}(\Lambda) = \bigoplus_{i=\text{odd}} E_i(\Lambda)$$

If $\Lambda = Z[G]$, let $W_i(\pm G) \subset St_i(\Lambda)$ denote the subgroup generated by the words $w_{pq}(\pm g)$ where $g \in G$ and p and q are in the indexing set $\{b_i^\alpha, z_i^\alpha\}$. Let

$$W_C(\pm G) = \bigoplus_i W_i(\pm G)$$

$$W_{ev}(\pm G) = \bigoplus_{i=\text{even}} W_i(\pm G)$$

$$W_{odd}(\pm G) = \bigoplus_{i=\text{odd}} W_i(\pm G).$$

Now let C be the graded Λ -module $\{C_i\}$ and let $\partial = \{\partial_i: C_i \rightarrow C_{i-1}\}$ be a boundary operator; that is $\partial_i \circ \partial_{i-1} = 0$ where composition is read from left to right. A contraction operator $\delta = \{\delta_i: C_i \rightarrow C_{i+1}\}$ for ∂ is a collection of Λ -linear maps satisfying $\delta_i \circ \delta_{i+1} = 0$ and $\delta_i \circ \partial_{i+1} + \partial_i \circ \delta_{i-1} = \text{id}$ on C_i . Let $\tilde{\zeta}$ denote the collection of such pairs. Then $St_C(\Lambda)$ acts on the left of $\tilde{\zeta}$ as follows: Let $x = (x_0, x_1, \dots, x_i, \dots) \in St_C(\Lambda)$ and let $(e_0, e_1, \dots, e_i, \dots) = (\pi_0(x_0), \pi_1(x_1), \dots, \pi_i(x_i), \dots) \in E_C(\Lambda)$. Let $(\partial, \delta) \in \tilde{\zeta}$ and define

$$x \cdot (\partial, \delta) = (x \cdot \partial, x \cdot \delta)$$

where

$$x \cdot \partial = \{e_i \cdot \partial_i \cdot e_{i-1}^{-1}\}$$

$$x \cdot \delta = \{e_i \cdot \delta_i \cdot e_{i+1}^{-1}\}$$

The action of $St_C(\Lambda)$ on the right of ζ is given by

$$(\partial, \delta) \cdot x = x^{-1} \cdot (\partial, \delta).$$

We shall always be concerned with pairs (∂, δ) of the form $x \cdot (\omega, \sigma)$ for some $x \in St_C(\Lambda)$ where (ω, σ) is the standard pair given by the equations

$$\omega_i(b_i^\alpha) = z_{i-1}^\alpha \quad \sigma_i(b_i^\alpha) = 0$$

and

$$\omega_i(z_i^\alpha) = 0 \quad \sigma_i(z_i^\alpha) = b_{i+1}^\alpha.$$

Note that pairs $(\partial, \delta) = x \cdot (\omega, \sigma)$ satisfy $\partial_i = \omega_i$ and $\delta_i = \sigma_i$ for almost all basis elements b_i^α and z_i^α .

If $\Lambda = Z[G]$ and $(\partial, \delta) \in \zeta$ we say that (∂, δ) is complex of elementary projections provided that for each $i \geq 0$

$$\partial_i(\text{basis element}) = \begin{cases} \pm g \text{ (basis element)} \\ \text{or} \\ 0 \end{cases}$$

Let $\Omega \subset St_C(\Lambda)$ denote the set of all $x \in St_C(\Lambda)$ such that $x \cdot (\omega, \sigma)$ is a complex of elementary projections. The aim of this

MORE ABOUT Wh_2

section is to construct a set map

$$\Sigma : \Omega \rightarrow Wh_2(G)$$

which, as we shall see in the next chapter, will induce the homomorphism

$$\Sigma : \pi_0(\mathcal{P}) \rightarrow Wh_2(\pi_1 M).$$

For suppose (η_t, f_t) , $0 \leq t \leq 1$, is an ordered path as in §2 of II where each f_t goes from $(M \times I; M \times 0, M \times 1)$ to $(I; 0, 1)$ and $f_0, f_1 \in \zeta$. Suppose further that all the birth and death points are independent. Then under a suitable identification (see IV, §1) of $\oplus_i St_i(Z[\pi_1 M])$ with a subgroup of $St_C(Z[\pi_1 M])$ we will have

$$\chi(\eta_t, f_t) \in \Omega$$

and hence can apply Σ to get an element of $Wh_2(\pi_1 M)$.

Recall that our "standard" Steinberg group $St(\Lambda)$ is formed using the indexing set $\Gamma = \{(i, j) | 0 \leq i, j < \infty\}$ which is linearly ordered as in §1. Make the following identifications:

$$\begin{array}{lll}
 z_{2k}^\alpha & \rightarrow & (2k, \alpha) \quad , \quad k \geq 0 \\
 b_{2k}^\alpha & \rightarrow & (2k-1, \alpha) \quad , \quad k \geq 1 \\
 b_{2k+1}^\alpha & \rightarrow & (2k, \alpha) \quad , \quad k \geq 0 \\
 z_{2k+1}^\alpha & \rightarrow & (2k+1, \alpha) \quad , \quad k \geq 0
 \end{array}$$

(*)

This induces homomorphisms

$$\text{St}_{\text{ev}}(\Lambda) \rightarrow \text{St}(\Lambda)$$

$$\text{St}_{\text{odd}}(\Lambda) \rightarrow \text{St}(\Lambda)$$

by which we can consider any element of St_{ev} or St_{odd} as an element of $\text{St}(\Lambda)$.

Let $C_{\text{ev}} = \bigoplus_{i=\text{even}} C_i$ and $C_{\text{odd}} = \bigoplus_{i=\text{odd}} C_i$ and let M be the free Λ -module generated by the indexing set Γ . The correspondences (*) induce identifications $C_{\text{ev}} \cong M$ and $C_{\text{odd}} \cong M$ which we henceforth take for granted.

For any $(\vartheta, \delta) \in \mathcal{L}$ the Λ -linear homomorphisms $\vartheta_{\text{ev}} + \delta_{\text{ev}}: C_{\text{ev}} \rightarrow C_{\text{odd}}$ and $\vartheta_{\text{odd}} + \delta_{\text{odd}}: C_{\text{odd}} \rightarrow C_{\text{ev}}$ are inverses of one another. For example, $\omega_{\text{ev}} + \sigma_{\text{ev}} = \text{identity} = \omega_{\text{odd}} + \sigma_{\text{odd}}$. Also, if $x \in \text{St}_{\mathcal{L}}(\Lambda)$, then for the pair $(x \cdot \omega, x \cdot \sigma) = x \cdot (\omega, \sigma)$ we have

$$x \cdot \omega_{\text{ev}} + x \cdot \sigma_{\text{ev}} = \pi \left(\prod_{0 \leq i} x_{2i} \prod_{0 \leq i} x_{2i+1}^{-1} \right) \in E(\Lambda)$$

and

$$x \cdot \omega_{\text{odd}} + x \cdot \sigma_{\text{odd}} = \pi \left(\prod_{0 \leq i} x_{2i+1} \cdot \prod_{0 \leq i} x_{2i}^{-1} \right) \in E(\Lambda)$$

where $x = (x_0, x_1, x_2, \dots)$.

Now let $\Lambda = \mathbb{Z}[G]$.

MORE ABOUT Wh_2

Lemma 3.1. Let $z \in \Omega \subset St_C(\Lambda)$. Then there is a $u \in W_C(\pm G)$ such that $u \cdot z \in \Omega$ and $uz \cdot \omega_w + uz \cdot \sigma_w \in \pi(U(\Lambda)) \subset E(\Lambda)$.

Proof. Since $z \in \Omega$, $z \cdot \omega$ is a complex of elementary projections and we can find a u in $W_C(\pm G)$ such that $uz \cdot \omega$ satisfies

$$(uz \cdot \omega)_{i+1}(b_{i+1}^\alpha) = \pm g_\alpha \cdot z_i^\alpha$$

and

$$(uz \cdot \omega)_{i+1}(z_{i+1}^\alpha) = 0.$$

This is the algebraic analogue of Step 3 in the proof of Prop. 3. in VI.

Therefore

$$(uz \cdot \sigma)_i(z_i^\alpha) = \pm g_\alpha^{-1} b_{i+1}^\alpha + \eta_{i+1}^\alpha$$

and

$$(uz \cdot \sigma)_i(b_i^\alpha) = \zeta_{i+1}^\alpha$$

for $\eta_{i+1}^\alpha \in Z_{i+1}$ and $\zeta_{i+1}^\alpha \in C_{i+1}$.

This implies that

$$uz \cdot \omega_{ev} + uz \cdot \sigma_{ev} \in \pi(U(\Lambda)).$$

Lemma 3.1 allows us to define

$$\Sigma: \Omega \rightarrow Wh_2(G) \quad .$$

as follows: Let $x \in \Omega$ and choose $u \in W_C(\pm G)$ as in (3.1). Set

$$(3.2) \quad \Sigma(x) = \left(\prod_{0 \leq i} u_{2i} \cdot x_{2i} \right) \cdot \left(\prod_{0 \leq i} x_{2i+1}^{-1} \cdot u_{2i+1}^{-1} \right) \text{ mod } U(\pm G).$$

Here $x = (x_0, x_1, \dots)$, $u = (u_0, u_1, \dots)$, and we consider $\text{Wh}_2(G)$ as $U(\Lambda) \text{ mod } U(\pm G)$.

Here is why (3.2) is independent of the choice u : The second Steinberg relation gives

$$\Sigma(x) = u_{\text{ev}} \cdot X \cdot u_{\text{odd}} \text{ mod } U(\pm G)$$

where

$$u_{\text{ev}} = \prod_i u_{2k} \in W(\pm G)$$

$$u_{\text{odd}} = \prod_i u_{2i+1}^{-1} \in W(\pm G)$$

$$X = \left(\prod_i x_{2i} \right) \cdot \left(\prod_i x_{2i+1}^{-1} \right) \cdot$$

Let $v \in W_C(\pm G)$ be another choice as in (3.2) and define v_{ev} and v_{odd} as above. Use (1.3) and (1.6) of §1 to find $h_u, h_v \in H(\pm G)$ and $t_u, t_v \in T$ such that

$$\pi(u_{\text{ev}} \cdot X \cdot u_{\text{odd}}) = \pi(h_u \cdot t_u)$$

and

$$\pi(v_{\text{ev}} \cdot X \cdot v_{\text{odd}}) = \pi(h_v \cdot t_v).$$

MORE ABOUT WH_2

Then using u to compute (3.2) we have

$$\Sigma(x) = h_u^{-1} \cdot u_{\mathcal{E}'} \cdot X \cdot u_{\text{odd}} \pmod{U(\pm G)}$$

and using v we have

$$\Sigma(x) = h_v^{-1} \cdot v_{\mathcal{E}'} \cdot X \cdot v_{\text{odd}} \pmod{U(\pm G)}.$$

By Proposition 2.4 the right hand sides of these equations are equal mod $U(\pm G)$.

Q.E.D.

CHAPTER IV. The Wh_2 invariant for pseudo-isotopies.

In this chapter we construct a homomorphism $\Sigma: \pi_0(\mathcal{P}) \rightarrow Wh_2(\pi_1 M)$ for any connected manifold M . In Chapter VI below we show that Σ is surjective for $n \geq 5$ and identify the kernel of Σ geometrically.

§1. Definition of $\Sigma: \pi_0(\mathcal{P}) \rightarrow Wh_2$.

Let M be any smooth connected manifold (compact, possibly with boundary) and let $[f] \in \pi_0(\mathcal{E})$ be a class represented by the function $f \in \mathcal{E}$. Join the standard projection p on $M \times I$ to f by a path f_t in \mathcal{E} where $f_0 = p$ and $f_1 = f$ ($0 \leq t \leq 1$). Deform f_t by a small amount keeping f_0 and f_1 fixed so that the one parameter family f_t is generic in the sense of (b) in §2 of I. Now choose a nice one-parameter family η_t of gradient like vector fields for the path f_t . If necessary suspend the family (η_t, f_t) as in §5 of I to get a new family on $(M \times D^k) \times I$, which we still call (η_t, f_t) , and which has the property that if p is a critical point of any f_t then $3 \leq \text{index}(p) \leq n + k - 2$. Using the general position methods of §4 in I, deform the path (η_t, f_t) keeping (η_0, f_0) and (η_1, f_1) fixed so that it satisfies the one-parameter ordering conditions (Proposition 8.1 of Chapter I); so that there are only finitely many crossings, births, deaths, and i/i -intersections and they all occur at different times; and so that each f_t is ordered and the birth and death points are independent.

Now let p_1, \dots, p_m denote the birth points in $(M \times D^k) \times I$ of the various functions f_t such that p_i is a birth point for f_{α_i} where $0 < \alpha_1 < \alpha_2 < \dots < \alpha_m < 1$. Suppose index $p_i = k_i$. The graphic near time $t = \alpha_i$ looks like

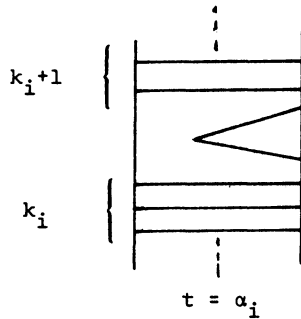

Choose a small $\epsilon > 0$ so there are no gradient crossings in the interval $[\alpha_i - \epsilon, \alpha_i + \epsilon]$. For $t = \alpha_i$ let $b_i(t) = p_i = z_i(t)$ and for $\alpha_i < t < \alpha_i + \epsilon$ let $b_i(t)$ be the critical point of f_t of index $k_i + 1$ coming from the birth point p_i and let $z_i(t)$ denote the critical point of index k_i coming from p_i . Choose once and for all a base point $v \in M \times 0 \times I \subset (M \times D^k) \times I$. Then

- (a) Select a base path γ_i from v to p_i
- (b) Let $\alpha_i < t_i < \alpha_i + \epsilon$ and choose orientations of $W(b_i(t_i))$ and $W(z_i(t_i))$ so that if $\partial = \partial_{i+1}(n_{t_i}, f_{t_i})$ then $\partial(b_i(t_i)) = + z_i(t_i)$.
- (c) Identify each $b_i(t_i)$ with some boundary index in $\{b_j^\alpha, z_j^\alpha\}$ where $j = k_i + 1$ and identify each $z_i(t)$ with the corresponding cycle index in $\{b_j^\alpha, z_j^\alpha\}$ where $j = k_i$. Thus if $b_i(t_i)$ goes to b_j^2 then $z_i(t_i)$ goes to z_{j-1}^2 . The choice for $b_i(t_i)$ determines the choice for $z_i(t_i)$.

This data determines for each $j > 0$ a word $\chi_j(\eta_t, f_t) = \chi_j \in \text{St}_j(z[\pi_1 M])$ as in Chapter II. Furthermore, since the function f with which we started has no critical points we have

$$\chi = (\chi_0, \chi_1, \dots) \in \Omega \subset \text{St}_C(z[\pi_1 M])$$

One way to see this is to use independence of birth-death points and the independence of trajectories principle to deform the path (η_t, f_t) , keeping each f_t ordered and each birth and death point independent during the deformation, so that for some $\delta > 0$ all the births occur at times between 0 and δ , all the deaths occur at times between $1 - \delta$ and 1, and there are no gradient crossings for $0 \leq t \leq \delta$ or $1 - \delta \leq t \leq 1$. Then $\partial(\eta_\delta, f_\delta)$ is just the standard-complex with boundary operator ω and $\partial(\eta_{1-\delta}, f_{1-\delta}) = \chi \cdot \omega$ is a complex of elementary projections because f has no critical points.

Finally we use (3.2) of Chapter III to define

$$\Sigma: \pi_0(\mathcal{E}) \rightarrow \text{Wh}_2(Z[\pi_1 M])$$

by the formula

$$(1.1) \quad \Sigma([f]) = \Sigma(\chi).$$

To prove that this gives a well-defined map we first show below that (1.1) is independent of the choices in (a), (b), and (c) above.

THE WH_2 INVARIANT FOR PSEUDO-ISOTOPIES

In §2 and §3 we show that Σ is independent of any deformation of the path (η_t, f_t) which keeps (η_0, f_0) fixed and moves (η_1, f_1) in $\hat{\mathfrak{E}}$.

Making choices differently in (a) through (c) produces a new χ' which can be derived from the original word χ by applying the following operation a finite number of times (cf. [19, Cor. 9.4]): Let $\chi = (\chi_0, \chi_1, \dots) \in \Omega$. Let p and q each denote a boundary index in dimension (or degree) $k + 1$ and also the corresponding cycle index in dimension k . (This is done because under the identifications (*) in §3 of Chapter III the boundary indices and corresponding cycle indices become the same). Let $g \in \pi_1 M$. Then χ is replaced by $\chi' = (\chi'_0, \chi'_1, \chi'_2, \dots) \in \Omega$ where

$$\begin{aligned}\chi'_j &= \chi_j && \text{for } j \neq k, k+1 \\ \chi'_k &= w_{pq}(\pm g) \cdot \chi_k \cdot w_{pq}(\pm g)^{-1} \\ \chi'_{k+1} &= w_{pq}(\pm g) \cdot \chi_{k+1} \cdot w_{pq}(\pm g)^{-1}\end{aligned}$$

We verify that $\Sigma(\chi) = \Sigma(\chi')$ in the case $k + 1 = 2d$ and leave the case $k + 1 = \text{odd}$ to the reader. Write $\chi_\alpha = \prod_{j \neq d} \chi_{2j}$ and $\chi_\beta = \prod_{j \neq d} \chi_{2j-1}$. Choose a $u \in W_C(\pm\pi_1 M)$ as in (3.1) of III to compute $\Sigma(\chi')$. Write $u = u_\alpha \cdot u_\beta$ where $u_\alpha \in W_{ev}(\pm\pi_1 M)$ and $u_\beta \in W_{\text{odd}}(\pm\pi_1 M)$. Then we have

$$\begin{aligned}
 \Sigma(\chi') &= u_\alpha \cdot w_{pq}(\pm g) \cdot \chi_{2d} \cdot w_{pq}(\pm g)^{-1} \cdot \chi_\alpha \cdot \chi_\beta^{-1} \cdot w_{pq}(\pm g) \cdot \chi_{2d-1}^{-1} \cdot w_{pq}(\pm g)^{-1} \cdot u_\beta^{-1} \\
 &= u_\alpha \cdot w_{pq}(\pm g) \cdot \chi_{2d} \cdot \chi_\alpha \cdot w_{pq}(\pm g)^{-1} \cdot w_{pq}(\pm g) \cdot \chi_\beta^{-1} \cdot \chi_{2d-1}^{-1} \cdot w_{pq}(\pm g)^{-1} \cdot u_\beta^{-1} \\
 &= u_\alpha \cdot w_{pq}(\pm g) \cdot \chi_{2d} \cdot \chi_\alpha \cdot \chi_\beta^{-1} \cdot \chi_{2d-1}^{-1} \cdot w_{pq}(\pm g)^{-1} \cdot u_\beta^{-1} \\
 &= \Sigma(\chi) \pmod{U(\pm\pi_1 M)}
 \end{aligned}$$

because the word $u_\alpha \cdot w_{pq}(\pm g) \cdot u_\beta \cdot w_{pq}(\pm g) \in W_C(\pm\pi_1 M)$ is a choice which satisfies (3.1) of III for the word χ . Note that as elements of $W_C(\pm\pi_1 M)$ the first $w_{pq}(\pm g)$ is in W_{ev} and the second is in W_{odd} . Considered as elements of $St(z[\pi_1, M])$ via (*) in §3 of III they become the same.

Remark. In view of (5.2) in §5 of I the invariant $\Sigma(\chi)$ does not depend on the number of times (n_t, f_t) is suspended.

§2. The three basic relations.

Any deformation of (η_t, f_t) as a path in $(\hat{\mathcal{L}}, \hat{\mathcal{E}}; \hat{p})$ can be made generic and then suspended so that the two parameter ordering conditions (8.2) of I can be realized. In particular, the independence of birth and death points is maintained except when the deformation passes through a dovetail singularity. As pointed out in §2 of II the word $\chi = \chi(\eta_t, f_t) \in St_C(z[\pi_1 M])$ does not change unless one of the deformations in Table 2.3 of II occurs. This geometrically oriented section analyzes how χ changes to a word χ' when these three changes in the graphic take place. The next section shows that the Σ invariant stays the same under the algebraic changes in the word χ .

(A) The exchange relation.

Let (η_t, f_t) be a path with no gradient crossings where each f_t is an ordered function with only non-degenerate critical points. Let the graphic be

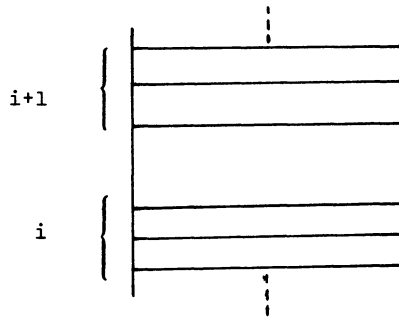

The matrix $\partial_{i+1} = \partial_{i+1}(\eta_t, f_t)$ is independent of t because there are no gradient crossings. Represent it as the matrix (a_{pq}) where $a_{pq} \in Z[\pi_1 M]$. (Thus we are assuming that the critical points of f_0 are based and the stable manifolds are oriented.) Now suppose that it is possible to deform the graphic as follows via a deformation of (η_t, f_t) :

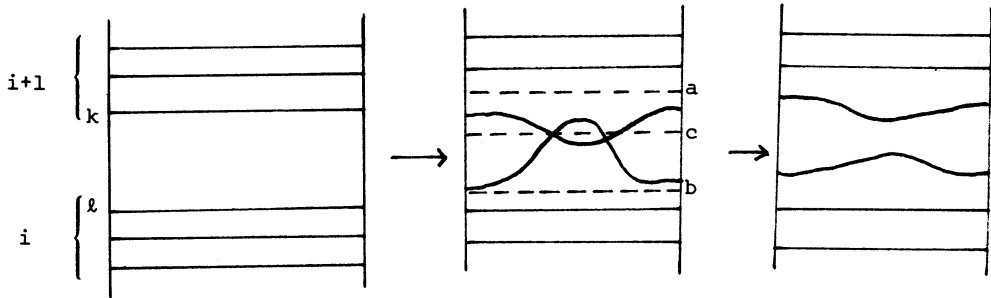
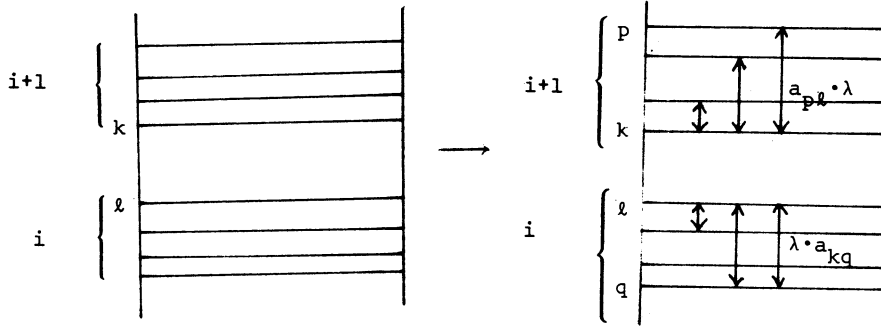

Diagram (a)

Then $a_{k\ell} = 0$ where p_k is the lowest critical point of f_0 of index $i + 1$ and q_ℓ is the highest critical point of index i of f_0 .

Lemma 2.1 (exchange). The most general change in the gradient crossings which occurs as a result of the above deformation of the graphic is

THE WH_2 INVARIANT FOR PSEUDO-ISOTOPIES



Here λ is any element of $\pi_1 M$. Thus the word

$$\prod_{p \neq k} x_{pk}(a_{pl} \cdot \lambda)$$

appears in degree $i + 1$ and the word

$$\prod_{q \neq l} x_{lq}(\lambda \cdot a_{kq})$$

appears in degree i . (Note that by the second Steinberg relation the order of the gradient crossings in degree $i + 1$ and in degree i is not important.)

Proof of 2.1. Let $f: X^{n+1} \rightarrow R$ be a Morse function on a compact manifold such that for some interval $[\alpha, \beta] \subset R$ there are just two non-degenerate critical points p and q in $f^{-1}([\alpha, \beta])$. Suppose index $p = i + 1$ and index $q = i$. Let η be a nice gradient-like vector field for f . For any $t \in R$ let $X_t = f^{-1}(t)$. Let c be

an intermediate value between $f(p)$ and $f(q)$. Suppose $S^{n-i} = W^*(q) \cap X_c$ and $S^i = W(p) \cap X_c$ are in general position in X_c so that they intersect transversely in finitely many points x_1, \dots, x_m . Then $V^{n-i}(q) = W^*(q) \cap X_a$ (see Diagram (a)) is the interior of an $(n-i)$ -dimensional Z_m -manifold whose m leaves fit together along the $(n-i-1)$ -sphere $S^{n-i-1} = W^*(p) \cap X_a$ (i.e. $\bar{V}(q) = V(q) \cup S^{n-i-1}$ is a Z_m -manifold with $V(q)$ the stratum of regular points and S^{n-i-1} the singular stratum).

In a neighborhood of S^{n-i-1} the j^{th} leaf L_j is determined as follows: Take a small disc $D_j^{n-i} \subset S^{n-i}$ in X_c which contains x_j but misses the other intersection points. Push $D_j^{n-i} - x_j$ along the trajectories of η until it is contained in X_a . This gives the leaf L_j . Similarly $V^i(p) = W(p) \cap X_b$ is an i -dimensional, Z_m -manifold whose leaves fit together along the $(i-1)$ -sphere $S^{i-1} = W(q) \cap X_b$.

We shall need to know the standard models for intersections of two parameter families of Z_m -manifolds.

A neighborhood U of a point in the singular stratum Σ of a Z_m -manifold V^n is of the form $Y \times R^{n-1}$ where Y is the cone on m points. If $0 \in Y$ denotes the cone point then $U \cap \Sigma = 0 \times R^{n-1}$. Consider the Z_μ -manifold $P^p \subset R^n$ and the Z_ν -manifold $Q^q \subset R^n$ defined as follows where $(p-1) + (q-1) = n-2$: Let $R^n = R \times R \times R \times R^{q-2} \times R^{p-1}$. The first R coordinate is the t -coordinate and the second is the s -coordinate. Let $Y \subset 0 \times (-\infty, -1] \times R \times 0 \times 0$ be the cone on μ points with vertex $y = (0, -1, 0, 0, 0)$:

THE WH_2 INVARIANT FOR PSEUDO-ISOTOPIES

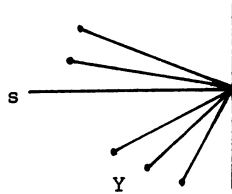

Let $Z \subset \mathbb{R} \times [0, \infty) \times 0 \times 0 \times 0$ be the cone on v points with vertex $z = (0, 0, 0, 0, 0)$.

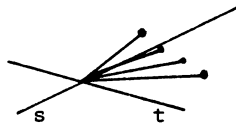

Let $P = 0 \times Y \times 0 \times \mathbb{R}^{p-1}$ be the Z_μ -manifold with singular stratum $\Sigma = 0 \times -1 \times 0 \times 0 \times \mathbb{R}^{p-1}$ and let $Q = Z \times \mathbb{R} \times \mathbb{R}^{q-2} \times 0$ with singular stratum $\Pi = 0 \times 0 \times \mathbb{R} \times \mathbb{R}^{q-2} \times 0$ as in the following diagram:

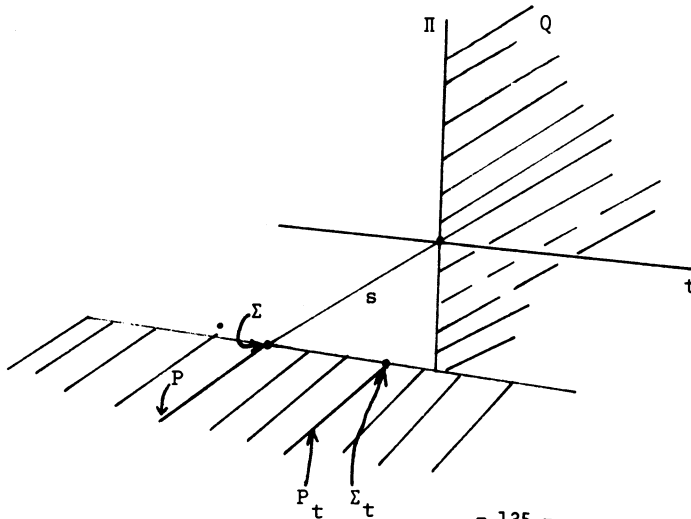

The family $P_t = t \times Y \times 0 \times \mathbb{R}^{p-1}$ with $\Sigma_t = t \times -1 \times 0 \times 0 \times \mathbb{R}^{p-1}$ is a one parameter deformation of $P = P_0$. Consider an isotopy: $\varphi_s: \mathbb{R}^2 \rightarrow \mathbb{R}^2$ as in the diagram

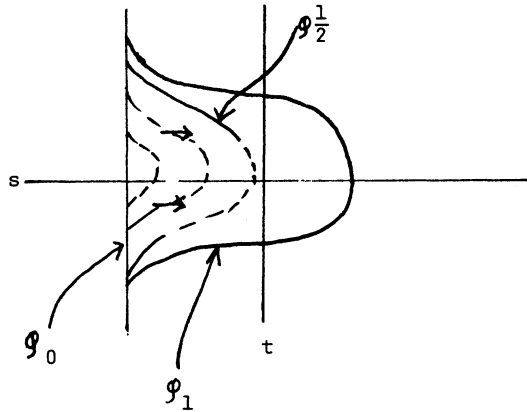

This induces an ambient isotopy of \mathbb{R}^n which deforms the one parameter family P_t in such a way that at time $s = \frac{1}{2}$ the singular set Σ of P intersects the singular set Π of Q in a single point as in the diagram below:

THE WH_2 INVARIANT FOR PSEUDO-ISOTOPIES

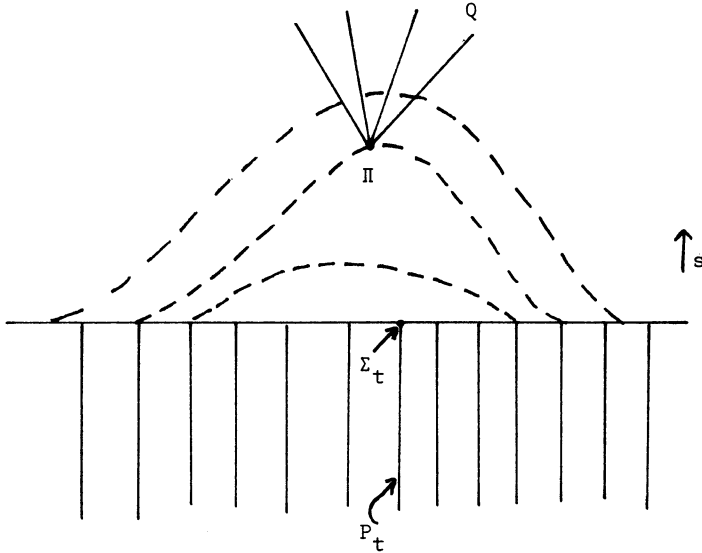

This isotopy (or its reverse) is the standard local model for a deformation of P_t to $P'_t = \mathcal{G}_1(P_t)$. Note that there will be finitely many times t when $\Sigma'_t \cap \text{int } Q$ is not empty and also finitely many times t where $\Pi \cap \text{int } P'_t$ is not empty.

Now for $i = 1, 2$ let M_i be a Z_{r_i} -manifold of dimension n_i . Let Σ_i denote the singular stratum of M_i (of dimension $n_i - 1$). Let $\alpha^i = \alpha^i_{t,s} : M_i \rightarrow C^n$ be two-parameter families of imbeddings where (t,s) runs through a parameter domain $D = [a,b] \times [c,d]$. Assume $(n_1 - 1) + (n_2 - 1) = n - 2$ and that $\alpha^1_{t,s}(\Sigma_1) \cap \alpha^2_{t,s}(\Sigma_2) = \emptyset$ for $(t,s) \in \partial D$. Then using the "elementary paths" technique of [3] we can show that each α^i can be deformed rel ∂D to new two parameter families (which for simplicity we call by the same names) such that

By deforming η_z just above the a-level and just below the b-level we can arrange that, for each $z \in D$, $S_\ell^{n-i}(z)$ intersects $S_\alpha^i(z)$ transversely and $S_k^i(z)$ intersects $S_\beta^{n-i}(z)$ transversely in $f_z^{-1}(b)$. Let $D \subset \text{int } D_1$ be a subdisc with ∂D close to $J = \partial D_1$ such that $W^*(p_k(z)) \cap W(q_\ell(z))$ is empty for $z \in D_1 - \text{int } D$. For each $z \in D$ let

$$S_\ell^{i-1}(z) = W(q_\ell(z)) \cap f_z^{-1}(c)$$

$$S_k^{n-i-1}(z) = W^*(p_k(z)) \cap f_z^{-1}(c)$$

$$V_\alpha^i(z) = W(p_\alpha(z)) \cap f_z^{-1}(c)$$

$$V_\beta^{n-i}(z) = W^*(q_\beta(z)) \cap f_z^{-1}(c).$$

Since transversality holds in the a-level and in the b-level and the $V_\alpha^i(z)$'s are diffeomorphic for $z \in D$ and so are the $V_\beta^{n-i}(z)$'s. Now by a z -preserving isotopy of the c-level deform $\eta_z \text{ rel } \partial D$ so that the two parameter families $S_\ell^{i-1}(z)$ and $S_k^{n-i-1}(z)$ satisfy (i) and (ii) above. For simplicity we assume there is just one parameter value $z_0 = (t_0, s_0) \in D$ where $S_\ell^{i-1}(z_0) \cap S_k^{n-i-1}(z_0) \neq \emptyset$. The general case reduces to this one easily. Let $g \in \pi_1 M$ denote the loop obtained by going along the base path to $q_\ell(z_0)$, then down the stable manifold $W(q_\ell(z_0))$ to the point $S_\ell^{i-1}(z_0) \cap S_k^{n-i-1}(z_0)$, then down the unstable manifold $W^*(p_k(z_0))$ to $p_k(z_0)$, and finally back along the base path of $p_k(z_0)$ to the base point. Near z_0 the deformation of $S_\ell^{i-1}(t, s)$ and $V_\beta^{n-i}(t, s)$ is like in the standard model. For $s < s_0$, $S_\ell^{i-1}(t, s)$ misses $V_\beta^{n-i}(t, s)$ (for t near t_0) but for $s_0 < s$ there are finitely many times t

near t_0 where $S_k^{i-1}(t,s) \cap V_\xi^{n-i}(t,s) \neq \emptyset$. Each such time t is where a new i/i -intersection takes place between $q_\xi(t,s)$ and $q_\xi(t,s)$. The algebraic number of leaves in the singular manifold $V_\beta^{n-i}(t,s)$ is determined by the coefficient $a_{k\xi}$ in the boundary matrix and this forces the coefficient in the Steinberg symbol $x_{k\xi}$ to be $(\pm g) \cdot a_{k\xi}$. Similarly for $s_0 < s$ there will be finitely many times where $S_k^{n-i-1}(t,s) \cap V_\alpha^i(t,s)$ is not empty and at each such time t there occurs a new $i+1/i+1$ -crossing between $p_\alpha(t,s)$ and $p_k(t,s)$. The algebraic number of leaves in $V_\alpha^i(t,s)$ is determined by the coefficient $a_{\alpha l}$ in the boundary matrix and hence the coefficient in the Steinberg symbol $x_{\alpha k}$ will be $a_{\alpha l} \cdot (\pm g)$.

To illustrate this proof of the exchange lemma we give a simple example. Consider the constant family $(\eta_t, f_t) = (\eta, f)$, $0 \leq t < 1$, with a graphic like

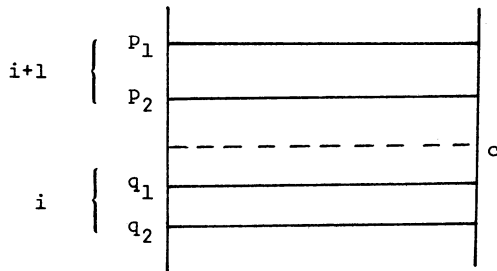

Suppose that $\partial_{i+1}(\eta, f)$ is the 2×2 identity matrix geometrically: which means the following: Let $S_\alpha^i = W(p_\alpha) \cap f^{-1}(c)$ and $S_\beta^{n-i} = W^*(q_\beta) \cap f^{-1}(c)$. Then $S_\alpha^i \cap S_\beta^{n-i} = \emptyset$ for $\alpha \neq \beta$ while both intersections $S_1^i \cap S_1^{n-i}$ and $S_2^i \cap S_2^{n-i}$ consist of exactly one transverse point. Let $g \in \pi_1 M$. Then by pushing the q_1 line up over the p_2 line and pulling it down again we can deform

(η_t, f_t) so that for $2 \leq i \leq n-2$ the change in the graphic looks like

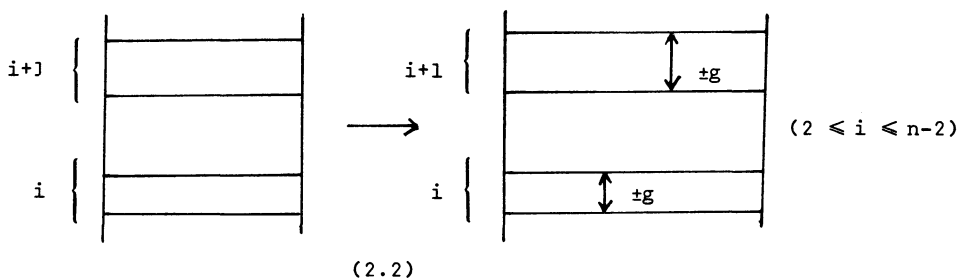

To see this first deform the graphic so that it looks like

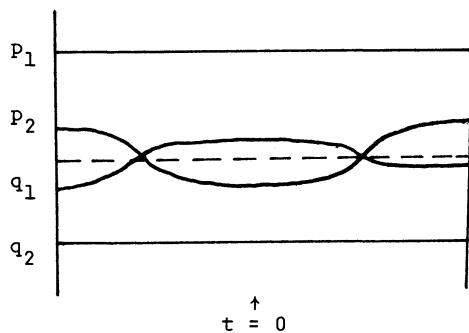

Let

$$S_t^{i-1} = W(q_1(t)) \cap f_t^{-1}(c)$$

$$D_t^i = V_1^i(t) = W(p_1(t)) \cap f_t^{-1}(c)$$

$$S_t^{n-i-1} = W^*(p_2(t)) \cap f_t^{-1}(c)$$

$$D_t^{n-i} = W^*(q_2(t)) \cap f_t^{-1}(c).$$

For simplicity assume that the families S_t^{i-1} and D_t^i are constant near $t = 0$. The isotopy of the intermediate c -level which produces the described deformation of (η_t, f_t) is illustrated by the diagram

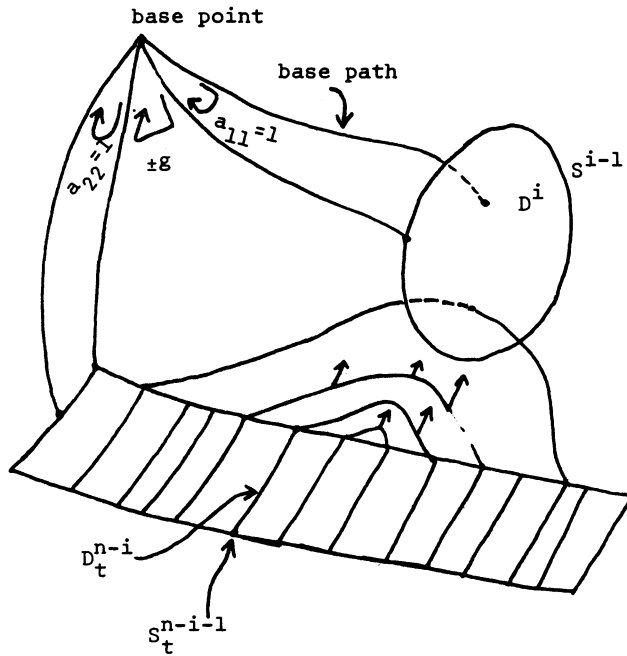

The lemma (2.1) is called the "exchange lemma" because it can be used to replace i/i -crossings by $i+1/i+1$ -crossings as follows:

THE WH_2 INVARIANT FOR PSEUDO-ISOTOPIES

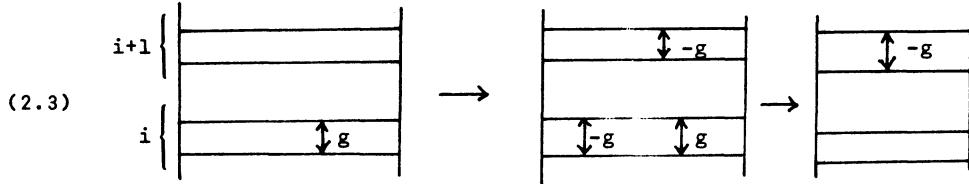

$$\partial(\eta, f) = \text{id}, \quad 2 \leq i \leq n - 2$$

(B) Birth-death relations.

Consider the following two deformations of graphics arising from a deformation of a path (η_t, f_t) , $0 \leq t \leq 1$, such that throughout the deformation the birth and death points are independent:

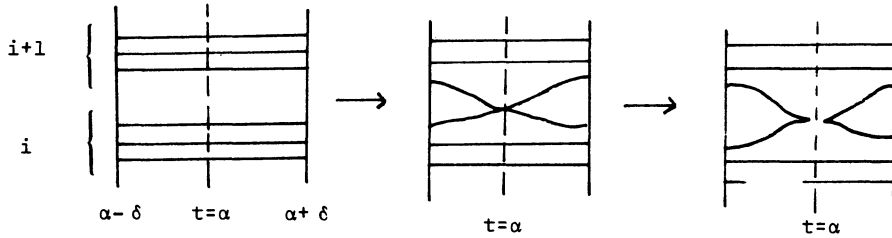

(1)

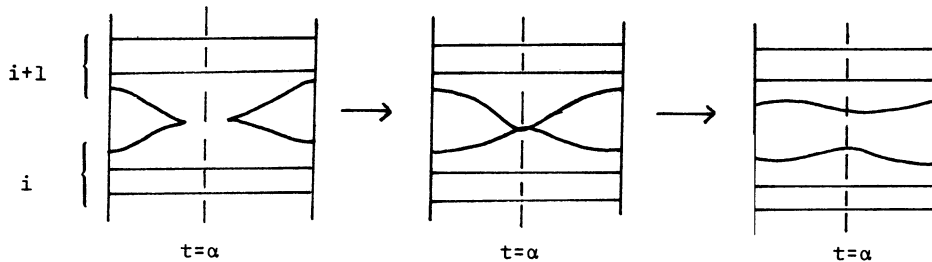

(2)

Suppose (η_t, f_t) is a path in general position as above and let $\chi = \chi(\eta_t, f_t) = (\chi_0, \chi_1, \dots)$ be the Steinberg multi-level word obtained as in §1 for the left most graphics.

Let $\chi_{i+1} = y \cdot x$ where x is the Steinberg word of $i+1/i+1$ -crossings which occur (in the left most graphic) before time $t = \alpha - \delta$ and y is the word composed of crossings (in the left most graphic) after time $t = \alpha + \delta$. Similarly write $\chi_i = b \cdot a$. The deformations of (η_t, f_t) indicated by the above changes in the graphic result in a new Steinberg word χ' obtained by replacing y and b by words y' and b' described below in (2.4). (Actually we only do the case corresponding to the first diagram and will let the reader do the second case.)

Redraw the diagram

THE WH_2 INVARIANT FOR PSEUDO-ISOTOPIES

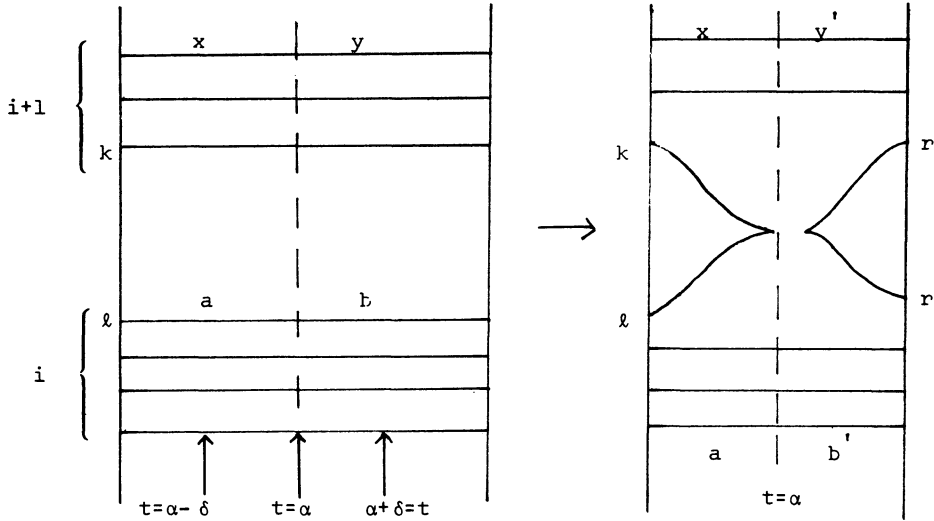

For (η_t, f_t) corresponding to the left hand graphic let $p_k(t)$ denote the lowest critical point of index $i+1$ of f_t and let $q_\ell(t)$ denote the highest critical point of index i of f_t ($\alpha - \delta \leq t \leq \alpha + \delta$). Throughout the deformation no gradient crossings occur and the birth and death points are independent.

Let $\partial_{i+1}(\eta_\alpha, f_\alpha): C_{i+1} \rightarrow C_i$ be represented by the matrix (a_{pq}) . Since $p_k(\alpha)$ and $q_\ell(\alpha)$ cancel each other in the deformation we know that $a_{k\ell} = \epsilon g$ for $g \in \pi_1 M$ and $\epsilon = \pm 1$. To get the new words y' and b' do the following:

- (a) Relabel $p_k(\alpha + \delta)$ as $p_r(\alpha + \delta)$ where r is a boundary index in degree $i+1$ not occurring in the words x and

$y \in \text{St}_{i+1}(z[\pi_1 M])$ (i.e. r doesn't occur as a subscript index in any symbol $x_{pq}(\lambda)$ appearing in x or y). Relabel $q_\ell(\alpha + \delta)$ as $q_r(\alpha + \delta)$ where r now denotes the corresponding cycle index in degree i . Also choose r so that it doesn't occur in a or b .

- (b) Let the base path for $q_r(\alpha + \delta)$ be the old base path ρ for $q_\ell(\alpha + \delta)$ and let the new base path for $p_r(\alpha + \delta)$ also be ρ . Note that if γ is the old base path for $p_k(\alpha + \delta)$, then ρ is g^{-1} followed by γ where as above $a_{k\ell} = \varepsilon \cdot g$.
- (c) Let the orientation for $W(q_r(\alpha + \delta))$ be the same as the one for $W(q_\ell(\alpha + \delta))$. Choose the new orientation for $W(p_r(\alpha + \delta))$ so that $\partial_{i+1}(p_r) = +q_r$. Thus the old orientation of $W(p_k(\alpha + \delta))$ is kept if $\varepsilon = +1$ and is changed if $\varepsilon = -1$.

The changes (a), (b), (c) will now give a new word y' arising from the $i+1/i+1$ -crossings occurring after $t = \alpha + \delta$ and also a new word b' coming from the i/i -crossings after $t = \alpha + \delta$. According to [19, Cor. 9.4] we have for $\varepsilon = \pm 1$

$$(2.4) \quad y' = w_{kr}(\bar{\tau}g) \cdot y \cdot w_{kr}(\bar{\tau}g)^{-1}$$

$$b' = w_{\ell r}(-1) \cdot b \cdot w_{\ell r}(-1)^{-1}.$$

(C) The dovetail relation.

This part studies the change in $\chi(\eta_t, f_t)$ resulting from the changing in the graphic



coming from the dovetail catastrophe. See Example 4 of §3 in I for notation.

Suppose that the above graphic results from the standard model for dovetail singularity. In general the birth and death points can not be made independent in the graphic for all $s < 0$ but only for all s less than some fixed negative number. This is what produces the dovetail relation.

Since $S^i(a_t) \cap D^{n-i}(c_t) \neq \emptyset$ (in the model in Example 4) for t near $-\delta$, independence near the birth point $c_{-\delta}$ fails. Similarly, independence near the death point c_δ fails too. However, independence of $c_{-\delta}$ and c_δ can be achieved by deforming the vector field η_t via an isotopy in v -level indicated by the following diagram:

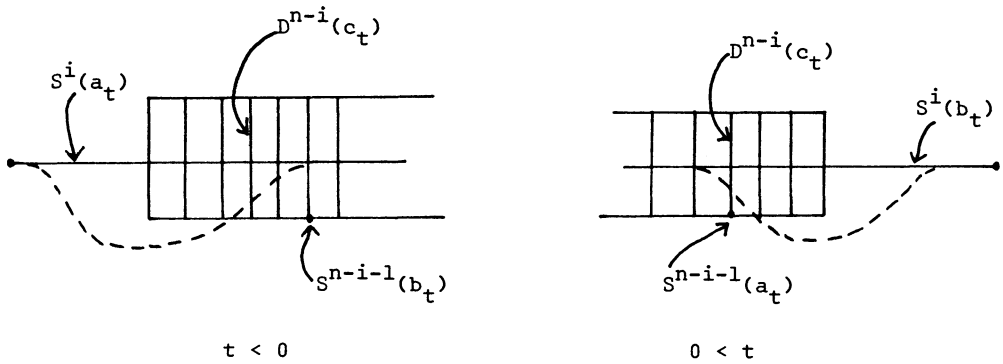

This process introduces $i+1/i+1$ -crossings of a_t over b_t and then b_t over a_t . Thus for all s less than a fixed negative number (which can be chosen arbitrarily small) the graphic looks like

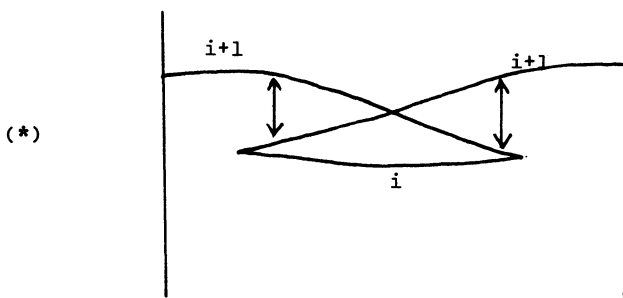

Now suppose we have a path (η_t, f_t) , $a \leq t \leq b$, with no gradient crossings in the graphic for $a - \epsilon \leq t \leq a + \epsilon \leq b$. Suppose the graphic is like

THE WH_2 INVARIANT FOR PSEUDO-ISOTOPIES

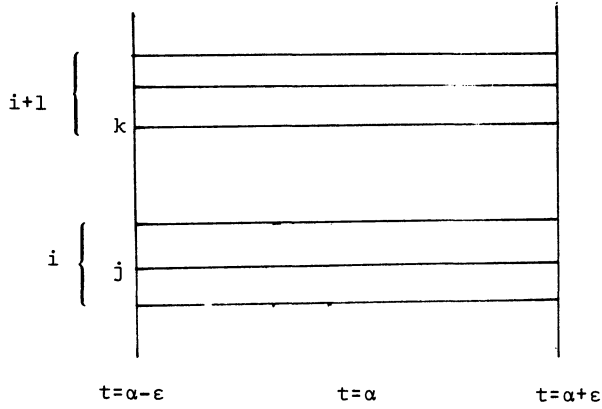

Let $p_k(t)$ denote the lowest critical point of f_t of index $i+1$ of f_t and let $q_j(t)$ denote the various critical points of f_t of index i .

Use the standard model for the dovetail singularity to deform the path (η_t, f_t) to one (η'_t, f'_t) having a graphic like

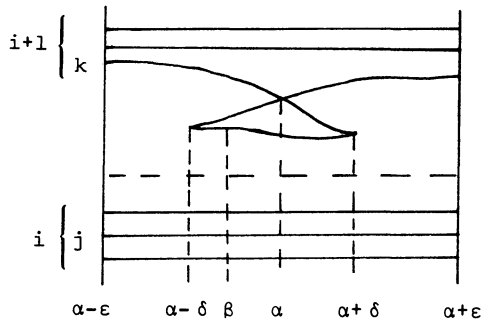

This can be done (see [5, Chap. 2]) so that the deformation has support in a small neighborhood of $W(p_k(\alpha)) \cup W^*(p_k(\alpha))$ and near $p_k(\alpha)$. For convenience we take $\alpha = 0$ and use the notation of Example 4 again.

We must deform (η'_t, f'_t) to achieve independence of the birth and death points: If the support of the deformation is small enough the birth and death points will be independent of all the $i+1$ index critical points except a_t and b_t . Use the procedure described above to make $c_{-\delta}$ and c_δ independent of a_t and b_t for t near $-\delta$ or t near $+\delta$. This produces two new $i+1/i+1$ -crossings as in (*) above.

In general, the birth and death points will not be independent of the critical points of index i for t near $\pm\delta$. Let $S^i(p_k(t)) = W(p_k(t)) \cap Q_t$ for $t < -\delta$ or $\delta < t$ and $S^{n-i}(q_j(t)) = W^*(q_j(t)) \cap Q_t$ for $-\epsilon \leq t \leq \epsilon$. The way in which $S^i(p_k(-\epsilon))$ intersects $S^{n-i}(q_j(-\epsilon))$ is measured by the coefficient a_{kj} in the boundary matrix $\partial_{i+1}(\eta_{-\epsilon}, f_{-\epsilon})$. If this intersection is not empty (i.e. when $a_{kj} \neq 0$) then (5) of Example 4 shows that quite possibly $D^i(c_{-\delta})$ and $S^{n-i}(q_j(-\delta))$ will have a non-empty intersection. However, this can be eliminated (thereby achieving independence of $c_{-\delta}$ and q_j) by using the process in §6 of I as follows: Choose a point z in $D^i(c_{-\delta})$ not contained in any $S^{n-i}(q_j(-\delta))$ and use an isotopy expanding away from z to push the intersections of $S^{n-i}(q_j(-\delta))$ with the sphere $D^i(c_{-\delta}) \cup \overset{\circ}{D}^i(a_{-\delta})$ into $\overset{\circ}{D}^i(a_{-\delta})$. Then for $t > -\delta$ but near $-\delta$ each $S^{n-i}(q_j(-\delta))$ can only intersect $\overset{\circ}{D}^i(b_t) \cup S^{i-1}(c_t) \cup \overset{\circ}{D}^i(a_t)$ in the subdisc $\overset{\circ}{D}^i(a_t)$. Similarly, for t near δ we can arrange that each $S^{n-i}(q_j(t))$ intersects $\overset{\circ}{D}^i(b_t) \cup S^{i-1}(c_t) \cup \overset{\circ}{D}^i(a_t)$ only

THE WH_2 INVARIANT FOR PSEUDO-ISOTOPIES

in $D^i(b_t)$. This gives the independence of $c_{-\delta}$ and c_δ . However, as t passes from $-\delta$ to δ the spheres $S^{n-i}(q_j(t))$ must pass across the sphere $S^{i-1}(c_t)$ in the intermediate level surface Q_t giving rise to i/i -crossings. Which crossings occur is determined by the coefficients a_{kj} in the boundary matrix.

A precise statement of how $\chi = \chi(\eta_t, f_t)$ changes to $\chi' = \chi(\eta'_t, f'_t)$ is the following: Write $\chi_{i+1} = y \cdot x$ where x comes from the $i+1/i+1$ crossings occurring before $t = \alpha$ and y comes from the $i+1/i+1$ crossings occurring after $t = \alpha$. Similarly, write $\chi_i = b \cdot a$. Now

- (1) Relabel the critical point $b(\beta)$ as $p_r(\beta)$ where r is a boundary index in degree $i+1$ which we assume doesn't appear in y or x . Relabel $c(\beta)$ as $q_r(\beta)$ where r is the corresponding cycle index in degree i which we assume not to appear in b or in a .
- (2) Leave the orientation of $p_r(\beta)$ the same as that of the original $p_k(\alpha+\epsilon)$, which is now labeled as $p_r(\alpha+\epsilon)$. Choose the orientation of $q_r(\beta)$ so that

$$\partial_{i+1}(p_r(\beta)) = + q_r(\beta).$$

- (3) Choose any path γ from the base point to $c_{-\delta}$ and use this as a base path for $p_r(\beta)$ and $q_r(\beta)$. Let g denote the loop composed of γ followed by the inverse of the base path for $p_k(\alpha)$.

Then finally we have

$$\begin{aligned} \chi_j' &= \chi_j \quad \text{for } j \neq i, i+1 \\ (2.5) \quad \chi_{i+1}' &= w_{kr}(-g^{-1}) \cdot y \cdot w_{kr}(-g^{-1})^{-1} \cdot x_{rk}(g) \cdot x_{kr}(-g^{-1}) \cdot x \\ \chi_i' &= b \cdot \left(\prod_{j \neq r} x_{rj}(-g \cdot a_{kj}) \right) \cdot a \end{aligned}$$

The graphic of (η_t', f_t') looks like

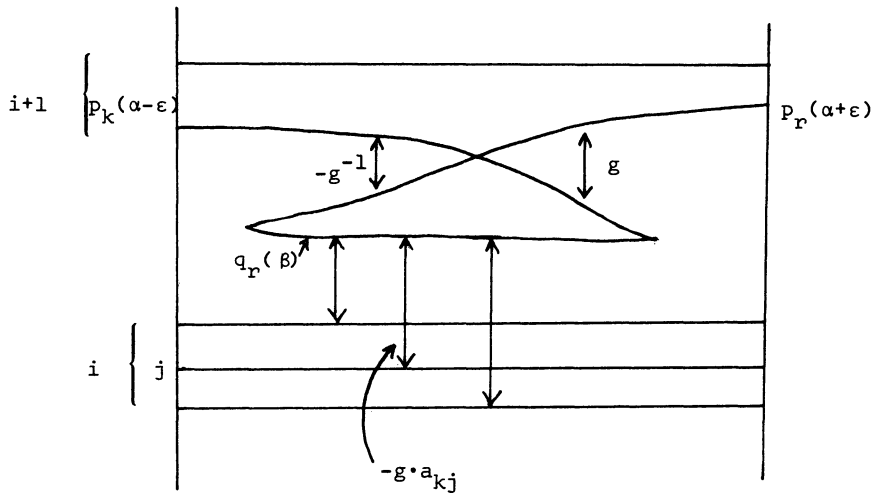

THE WH_2 INVARIANT FOR PSEUDO-ISOTOPIES

If the graphic changes like

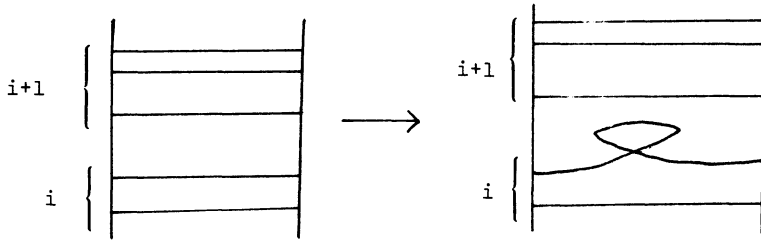

then gradient crossings are introduced as follows:

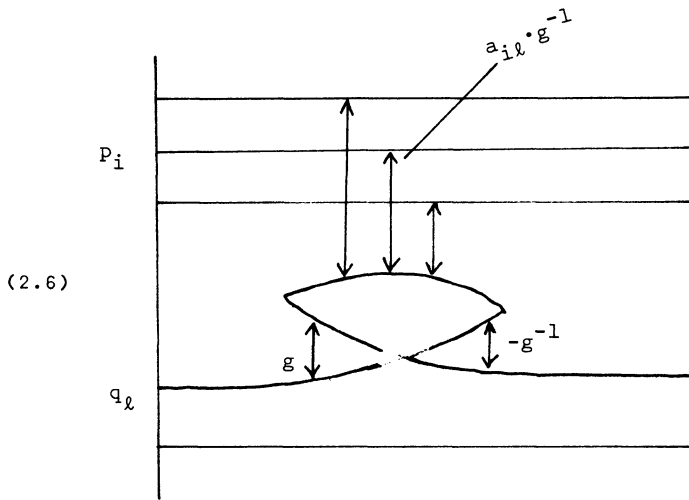

As a corollary of the analysis of deformations through the dovetail singularity we have

Lemma 2.7. Let M^n be a smooth manifold with $n \geq 4$. Let $2 \leq i \leq n - 2$. Let $f_t: (M \times I; M \times 0, M \times I) \rightarrow (I; 0, I)$ be a path of functions where f_t has no critical points. Let η_t be a path of gradient-like vector fields for f_t . Let $\prod w_\nu$ be a word in $St(r, Z[\pi_1 M])$ where each w_ν is of the form $w_{kl}(\pm g)$ for some $\pm g \in \pi_1 M$. Then (η_t, f_t) can be deformed, keeping (η_0, f_0) and (η_1, f_1) fixed, to (η'_t, f'_t) which has only $i+1/i+1$ -crossings and such that

$$\chi_{i+1}(\eta'_t, f'_t) = \prod_{\nu} w_{\nu}$$

Proof. Here is how to realize a single word $w_{kl}(\pm g)$.

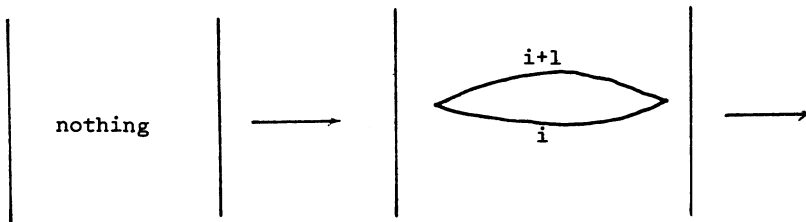

THE WH_2 INVARIANT FOR PSEUDO-ISOTOPIES

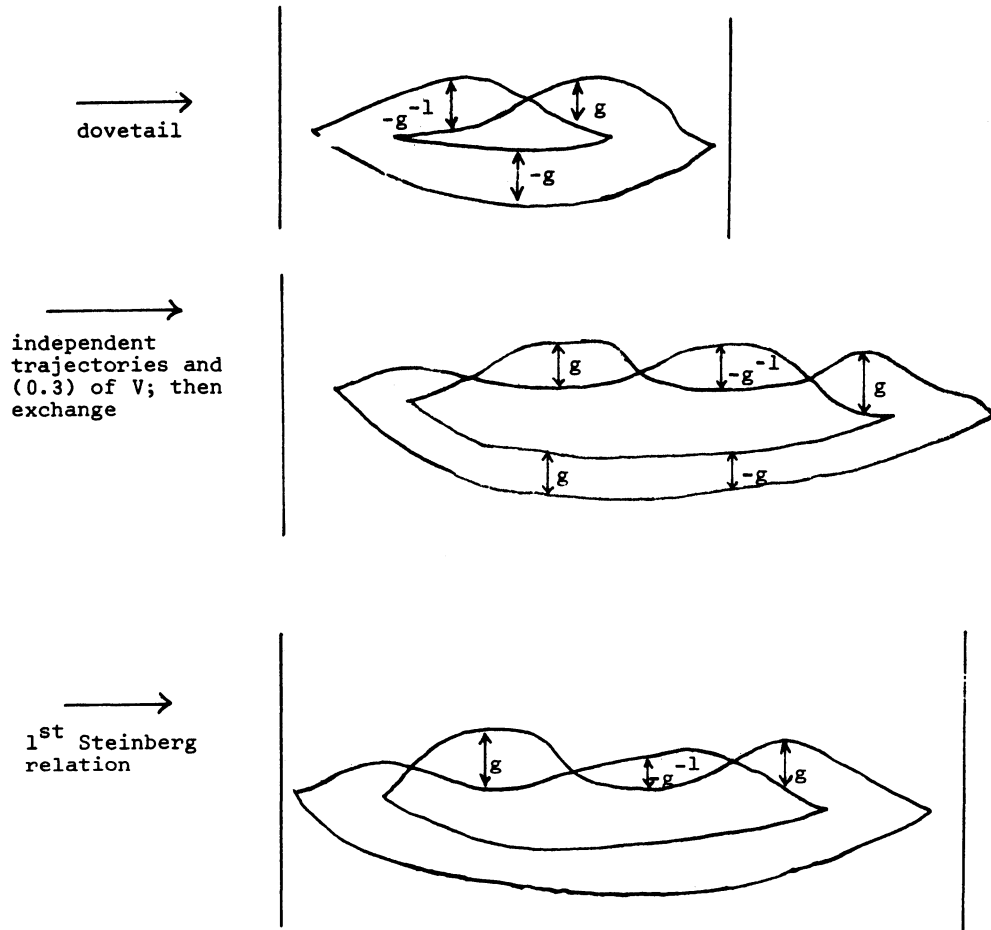

The product $\prod_{\nu} w_{\nu}$ is then built up by joining these elementary blocks together by the uniqueness of birth lemma (0.1) in V .

§3. $\Sigma: \pi_0(\mathcal{P}) \rightarrow \text{Wh}_2$ is well-defined.

To show that Σ is well-defined it is enough (as remarked in §2 of II) to show that Σ stays the same when χ is changed in one of the three ways in Table 2.3. (i.e. when χ changes as in (2.1), (2.4) or (2.5) of the previous section).

(3.1) Exchange relation.

Let $\chi = (\chi_0, \chi_1, \dots) \in \Omega$ and suppose that $\chi_i = b \cdot a$ and $\chi_{i+1} = y \cdot x$ for $a, b \in \text{St}_i(\Lambda)$ and $x, y \in \text{St}_{i+1}(\Lambda)$. Represent $\partial_{i+1} = x \cdot \omega_{i+1} \cdot a^{-1}: C_{i+1} \rightarrow C_i$ by the matrix (a_{pq}) where the indices are "concentrated" in degrees $i+1$ and i (i.e. $p \in \{b_{i+1}^\alpha, z_{i+1}^\alpha\}$ and $q \in \{b_i^\alpha, z_i^\alpha\}$). Suppose for some pair of indices (k, ℓ) that $a_{k\ell} = 0$ and let $\lambda \in \Lambda$. Let

$$\chi' = (\chi_0, \chi_1', \dots) \in \Omega$$

be defined by

$$\chi' = (\chi_0, \dots, \chi_{i-1}, b \cdot \gamma \cdot a, y \cdot \varepsilon \cdot x, \chi_{i+2}, \dots) \text{ where}$$

$$\varepsilon = \prod_{p \neq k} x_{pk}(a_{p\ell} \cdot \lambda) \quad \text{for } p \text{ concentrated in degree } i+1$$

and

$$\gamma = \prod_{q \neq \ell} x_{\ell q}(\lambda \cdot a_{kq}) \quad \text{for } q \text{ concentrated in degree } i.$$

THE WH_2 INVARIANT FOR PSEUDO-ISOTOPIES

We shall do the case $i+1 = 2c$ and leave the case $i+1 = \text{odd}$ to the reader. Choose $u \in W_C(\pm\pi_1 M)$ as in (3.1) of III for $\chi \in \Omega$. This choice also satisfies (3.1) for $\chi' \in \Omega$. Let $\chi_\alpha = \prod_{j \neq c} \chi_{2j}$, $\chi_\beta = \prod_{j \neq c} \chi_{2j-1}$, $u_\alpha = \prod_{j \neq c} u_{2j}$, and $u_\beta = \prod_{j \neq c} u_{2j-1}$.

Let $\bar{\chi} = (u_0 \cdot \chi_0, u_1 \cdot \chi_1, \dots, a, x, u_{i+2} \cdot \chi_{i+2}, \dots) \in St_C(\Lambda)$. Finally let $(\partial, \delta) = \bar{\chi} \cdot (\omega, \sigma)$.

Represent the map $\partial_{ev} + \delta_{ev}: C_{ev} \rightarrow C_{odd}$ by the matrix (A_{pq}) . If p is in degree $2c$ and q is in degree $2c-1$, then $A_{pq} = a_{pq}$. In particular $A_{kl} = 0$. See the following diagram which illustrates the case $i+1 = 4$.

HATCHER & WAGONER

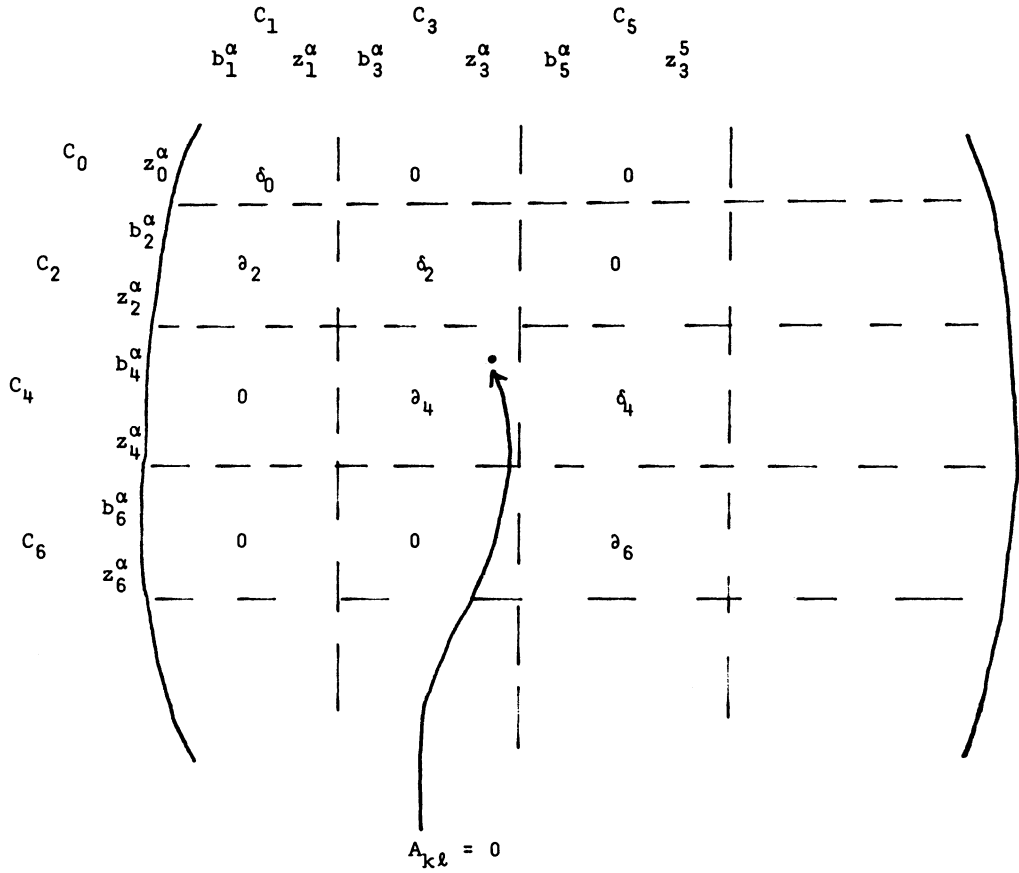

We have

$$\Sigma(\chi) = u_{2c} \cdot y \cdot x \cdot u_\alpha \chi_\alpha \chi_\beta^{-1} \cdot u_\beta^{-1} \cdot a^{-1} \cdot b^{-1} \cdot u_{2c-1}^{-1}$$

and

$$\Sigma(\chi') = u_{2c} \cdot y \cdot \varepsilon \cdot x \cdot u_\alpha \chi_\alpha \chi_\beta^{-1} \cdot u_\beta^{-1} \cdot a^{-1} \cdot \gamma^{-1} \cdot b^{-1} \cdot u_{2c-1}^{-1} .$$

Let $\varepsilon_1 = \prod_p x_{pk}(A_{p\ell} \cdot \lambda)$ where p runs through the indices of even degree less than $2c$. Let $\gamma_1 = \prod_q x_{\ell q}(\lambda \cdot A_{kq})$ where q runs through the indices of odd degree greater than $2c-1$. Then $\varepsilon_1, \gamma_1 \in T$ and the second and third Steinberg relations imply that

$$u_{2c} \cdot y \cdot \varepsilon_1 = t' \cdot u_{2c} \cdot y$$

and

$$\gamma_1^{-1} \cdot b^{-1} \cdot u_{2c-1}^{-1} = b^{-1} \cdot u_{2c-1}^{-1} \cdot t''$$

where t' and t'' lie in T .

Let $\varepsilon_2 = \varepsilon_1 \cdot \varepsilon = \prod_{p \neq k} x_{pk}(A_{p\ell} \cdot \lambda)$, where now p runs through all indices of even degree. Let $\gamma_2 = \gamma_1 \cdot \gamma = \prod_{q \neq \ell} x_{\ell q}(\lambda \cdot A_{kq})$, where now q runs through the indices of odd degree. Then we have

$$\Sigma(\chi') = u_{2c} \cdot y \cdot \varepsilon_2 \cdot x \cdot \chi_\alpha \cdot \chi_\beta^{-1} \cdot u_\beta^{-1} \cdot a^{-1} \cdot \gamma_2^{-1} \cdot b^{-1} \cdot u_{2c-1}^{-1} \pmod T.$$

Now apply the exchange lemma (2.1) of III to the word

$\varepsilon_2 \cdot x \cdot u_\alpha \chi_\alpha \chi_\beta^{-1} u_\beta^{-1} a^{-1} \gamma_2^{-1} \in St(\Lambda)$ to conclude that it is equal to $x \cdot u_\alpha \chi_\alpha \chi_\beta^{-1} u_\beta^{-1} a^{-1}$. Hence we have $\Sigma(\chi') = \Sigma(\chi) \pmod T$; i.e. $\Sigma(\chi') = \Sigma(\chi)$

in $Wh_2(\pi_1 M) = U(\Lambda) \pmod U(\pm \pi M)$.

(3.2) Birth-death relation.

We shall go through the argument for the relation corresponding to the diagram (1) in (B) in the previous §2. The argument for the diagram (2) is similar.

Let $\chi = (\chi_0, \chi_1, \dots) \in \Omega$ where $\chi_i = b \cdot a$ and $\chi_{i+1} = y \cdot x$. Let $\partial_{i+1} = x \cdot w_{i+1} a^{-1}: C_{i+1} \rightarrow C_i$ be represented by the matrix (a_{pq}) such that for some fixed pair of indices (k, ℓ) we have $a_{p\ell} = 0$ and $a_{kq} = 0$ whenever $p \neq k$ and $q \neq \ell$. Suppose $a_{k\ell} = \pm g$ for some $g \in \pi_1 M$. Let r be a boundary index in degree $i+1$ not occurring in the word χ_{i+1} (i.e. r doesn't appear as a subscript index in any symbol $x_{\mu\nu}(\lambda)$ in the word χ_{i+1}). Let r denote the corresponding cycle index in degree i and suppose r has been chosen so that it doesn't occur in the word χ_i . Define $\chi \in \Omega$ by

$$\begin{aligned} \chi'_j &= \chi_j && \text{for } j \neq i, i+1 \\ \chi'_{i+1} &= w_{kr}(\mp g) \cdot y \cdot w_{kr}(\mp g)^{-1} \cdot x \\ \chi'_i &= w_{\ell r}(-1) \cdot b \cdot w_{\ell r}(-1)^{-1} \cdot a. \end{aligned}$$

See (2.4) in §2 above.

Let $\bar{\chi} = (\chi_0, \chi_1, \dots, a, x, \chi_{i+2}, \dots) \in \text{St}_C(\Lambda)$. Assume that $i+1 = 2c$. The case $i+1 = \text{odd}$ is similar.

Let $(\partial, \partial) = \bar{\chi} \cdot (\omega, \sigma)$. Let $\partial_{ev}^+ \&_{ev}: C_{ev} \rightarrow C_{\text{odd}}$ be represented by the matrix (A_{pq}) . We know by hypothesis that for the fixed pair of indices (k, ℓ) that $A_{k\ell} = \pm g$ while $A_{p\ell} = 0$ and $A_{kq} = 0$ for all $p \neq k$ concentrated in degree $i+1$ and all $q \neq \ell$ concentrated in degree i .

THE WH_2 INVARIANT FOR PSEUDO-ISOTOPIES

Now choose $u \in W_C(\pm\pi_1 M)$ as in (3.1) of III to compute $\Sigma(\chi')$.
 Let $u_\alpha = \prod_{j \neq c} u_{2j}$, $u_\beta = \prod_{j \neq c} u_{2j-1}$, $\chi_\alpha = \prod_{j \neq c} \chi_{2j}$, and $\chi_\beta = \prod_{j \neq c} \chi_{2j-1}$.
 Then

$$\Sigma(\chi') = u_{2c} w_{kr}(\mp g) y w_{kr}(\mp g)^{-1} x u_\alpha \chi_\alpha \chi_\beta^{-1} u_\beta^{-1} a^{-1} w_{lr}(-1) b^{-1} w_{lr}(-1)^{-1} u_{2c-1}^{-1}$$

Let t_1 and t_2 in T be defined by $t_1 = \prod_p x_{pk}(-A_{pk} \cdot (\pm g)^{-1})$
 for p in even degree less than $2c$ and $t_2 = \prod_q x_{lq}(-(\pm g)^{-1} A_{kq})$
 for p of odd degree greater than $2c-1$. The two crucial properties
 enjoyed by t_1 and t_2 are

(a) Let $\Gamma = x u_\alpha \chi_\alpha \chi_\beta^{-1} u_\beta^{-1} a^{-1}$. Then $\pi(t_1 \cdot \Gamma \cdot t_2) \in E(\Lambda)$ has only a
 single non-zero entry in the k^{th} row or the l^{th} column;
 namely, $\pm g$ in the $(k, l)^{\text{th}}$ spot.

(b) The second and third Steinberg relations imply that there are
 t_1' and t_2' in T so that

$$t_1' \cdot u_{2c} \cdot w_{kr}(\mp g) \cdot y \cdot w_{kr}(\mp g)^{-1} = u_{2c} \cdot w_{kr}(\mp g) \cdot y \cdot w_{kr}(\mp g)^{-1} \cdot t_1'$$

and

$$t_2' \cdot w_{lr}(-1) \cdot b^{-1} \cdot w_{lr}(-1)^{-1} \cdot u_{2c-1}^{-1} = w_{lr}(-1) \cdot b^{-1} \cdot w_{lr}(-1)^{-1} \cdot u_{2c-1}^{-1} \cdot t_2'$$

It now follows from (b) that modulo T

$$\Sigma(\chi') = u_{2c} \cdot w_{kr}(\mp g) \cdot y \cdot \{w_{kr}(\mp g)^{-1} \cdot t_1' \cdot \Gamma \cdot t_2' \cdot w_{lr}(-1)\} \cdot b^{-1} \cdot w_{lr}(-1)^{-1} \cdot u_{2c-1}^{-1}.$$

Apply the birth-death relation (2.3) of III to the subword enclosed

by brackets to get

$$\begin{aligned}
 \Sigma(\chi') &= u_{2c} \cdot w_{kr}(\bar{f}g) \cdot y \cdot t_1 \cdot \Gamma \cdot t_2 \cdot b^{-1} \cdot w_{lr}(-1)^{-1} \cdot u_{2c-1}^{-1} \\
 &= t_1' \cdot u_{2c} \cdot w_{kr}(\bar{f}g) \cdot y \cdot \Gamma \cdot b^{-1} \cdot w_{lr}(-1)^{-1} \cdot u_{2c-1}^{-1} \cdot t_2' \\
 &= u_{2c} \cdot w_{kr}(\bar{f}g) \cdot y \cdot \Gamma \cdot b \cdot w_{lr}(-1)^{-1} \cdot u_{2c-1}^{-1} \pmod{T} \\
 &= (u_{2c} \cdot w_{kr}(\bar{f}g) \cdot u_\alpha) \cdot y \cdot x \cdot \chi_\alpha \chi_\beta^{-1} \cdot a^{-1} \cdot b^{-1} \cdot (u_\beta^{-1} \cdot w_{lr}(-1)^{-1} \cdot u_{2c-1}^{-1}) \\
 &= \Sigma(\chi) .
 \end{aligned}$$

The last step is valid because Σ is independent of the choice of u used in (3.1) of III.

(3.3) Dovetail relation.

We shall verify that $\Sigma(\chi)$ remains the same under the change (2.5). The argument for (2.6) is similar.

Let $\chi = (\chi_0, \chi_1, \dots) \in \Omega$ where $\chi_i = b \cdot a$ and $\chi_{i+1} = y \cdot x$. Let $\partial_{i+1} = x \cdot w_{i+1} a^{-1}: C_{i+1} \rightarrow C_i$ be represented by the matrix (a_{pq}) . Let r denote a boundary index of degree $i+1$ and also the corresponding cycle index of degree i . Suppose r doesn't occur in χ_i or χ_{i+1} . Let $k \neq r$ be any index of degree $i+1$. Let $g \in \pi_1 M$ and define $\chi' \in \Omega$ by the equations

$$\begin{aligned} \chi'_j &= \chi_j && \text{for } j \neq i, i+1 \\ \chi'_{i+1} &= w_{kr}(-g^{-1}) \cdot y \cdot w_{kr}(-g^{-1})^{-1} \cdot x_{rk}(g) \cdot x_{kr}(-g^{-1}) \cdot x \\ \chi'_i &= b \cdot \left(\prod_{j \neq r} x_{rj}(-g \cdot a_{kj}) \right) \cdot a . \end{aligned}$$

As usual we take $i+1 = 2c$ and leave the case $i+1 = \text{odd}$ as an exercise. Let

$$\bar{\chi} = (\chi_0, \dots, a, x, \chi_{i+2}, \dots) \text{ and } (\partial, \delta) = \bar{\chi} \cdot (\omega, \sigma).$$

Let (A_{pq}) be the matrix representation of $\partial_{ev} + \partial_{ev}: C_{ev} \rightarrow C_{odd}$. Choose $u \in W_C(\pm \pi_1 M)$ as in (3.1) of III to compute $\Sigma(\chi')$. Let $u_\beta, u_\alpha, \chi_\alpha$, and χ_β be defined as in (3.2) above. Then

$$\Sigma(\chi') = u_{2c} \cdot w_{kr}(-g^{-1}) \cdot y \cdot w_{kr}(-g^{-1})^{-1} \{ x_{rk}(g) \cdot x_{kr}(-g^{-1}) \cdot \Gamma \} b^{-1} \cdot u_{2c-1}^{-1}$$

where

$$\Gamma = x u_{\alpha} \chi_{\alpha} \chi_{\beta}^{-1} u_{\beta}^{-1} a^{-1} \left(\prod_{j \neq r} x_{rj} (-g A_{kj}) \right)$$

for j concentrated in degree $2c-1$. As in (3.1) and (3.2) it is easy to show that Γ is equal modulo T to the same expression where j runs through all odd degrees greater than or equal to $2c-1$. Apply the dovetail relation (2.2) to the word in brackets using this enlarged Γ to conclude that it is equal to $w_{rk}(g) x u_{\alpha} \chi_{\alpha} \chi_{\beta}^{-1} u_{\beta}^{-1} a$. Thus

$$\Sigma(\chi') = u_{2c} w_{kr}(-g^{-1}) y w_{kr}(-g^{-1})^{-1} w_{rk}(g) x u_{\alpha} \chi_{\alpha} \chi_{\beta}^{-1} u_{\beta}^{-1} a^{-1} b^{-1} u_{2c-1}^{-1}$$

By Lemma 9.5 of [19], $w_{rk}(g) = w_{kr}(-g^{-1})$ and hence

$$\begin{aligned} \Sigma(\chi') &= u_{2c} w_{kr}(-g^{-1}) y x u_{\alpha} \chi_{\alpha} \chi_{\beta}^{-1} u_{\beta}^{-1} b^{-1} a^{-1} u_{2c-1} \\ &= \Sigma(\chi) \text{ mod } U(\pm\pi_1 M). \end{aligned}$$

This completes the proof that $\Sigma: \pi_0(\mathcal{P}) \rightarrow Wh_2(\pi_1 M)$ is well-defined.

§4. Σ is a homomorphism.

We show in this section that for $[f],[g]$ in $\pi_0(\mathcal{E}) \cong \pi_0(\mathcal{P})$ we have

$$(4.1) \quad \Sigma([f] \cdot [g]) = \Sigma([f]) + \Sigma([g]).$$

The "#" operation of §1 of I defined on \mathcal{F} extends naturally to $\hat{\mathcal{F}}$ so that if η is gradient-like for f and ζ is gradient-like for g then $\eta\#\zeta$ is gradient-like for $f\#g$.

Let $[f],[g] \in \pi_0(\mathcal{E})$ and choose paths (η_t, f_t) and (ζ_t, g_t) in $\hat{\mathcal{F}}$ as in §1 of IV so that $\Sigma([f]) = \Sigma(\chi(\eta_t, f_t))$ and $\Sigma([g]) = \Sigma(\chi(\zeta_t, g_t))$.

Then we have

graphic of $(\eta_t \# \zeta_t, f_t \# g_t)$	= by definition	graphic of (ζ_t, g_t) <hr style="border: 0; border-top: 1px dashed black; width: 100%; margin: 5px 0;"/> graphic of (η_t, f_t)
---	-------------------------------	--

$$= \left[\begin{array}{c|c} & \text{graphic of} \\ & (\zeta_t, g_t) \\ \hline \text{graphic of} & \\ (\eta_t, f_t) & \end{array} \right]$$

$$= \left[\begin{array}{c|c} \text{ordered graphic of} & \text{ordered graphic of} \\ (\eta_t, f_t) & (\zeta_t, g_t) \end{array} \right]$$

Let $\chi(\eta_t, f_t) = \alpha = (\alpha_0, \alpha_1, \dots)$ and $\chi(\zeta_t, g_t) = \beta = (\beta_0, \beta_1, \dots)$. To calculate $\chi(\zeta_t, g_t)$ we can replace β by $w \cdot \beta \cdot w^{-1}$ where $w \in W_c(\pm \pi_1 M)$ is chosen as in §1 of IV. Pick a w so that the indices appearing as subscripts in the symbols x_{pq}^λ in any new β_j are different from any indices appearing in the α_i 's.

Then

$$\begin{aligned}
 \Sigma([f] \cdot [g]) &= \Sigma(\chi(\eta_t \# \zeta_t, f_t \# g_t)) \\
 &= \prod_i (\alpha_{2i} \beta_{2i}) \cdot \prod_i (\alpha_{2i-1} \beta_{2i-1})^{-1} \pmod{W(\pm\pi_1 M)} \\
 &= \left(\prod_i \alpha_{2i} \right) \left(\prod_i \alpha_{2i-1}^{-1} \right) \left(\prod_i \beta_{2i} \right) \left(\prod_i \beta_{2i-1}^{-1} \right) \\
 &= \Sigma(\chi(\eta_t, f_t)) \cdot \Sigma(\zeta(\chi_t, g_t)) \\
 &= \Sigma([f]) + \Sigma([g]).
 \end{aligned}$$

CHAPTER V. Deformations of the Graphic

This chapter discusses a number of ways to change and simplify the graphic of a k -parameter family (η_z, f_z) by a deformation of (η_z, f_z) . For convenience we list below certain changes in the graphic which will be needed later in this paper. They are special cases of more general results in §1 and §2 of this chapter and in [5]. In each of the following the graphic on the left hand side will be that of a one parameter family (η_t, f_t) where each f_t is a function from $(V^{n+1}; C, D)$ to $(I; 0, 1)$ and V, C, D are connected. The claim is that each of the deformations of the graphics can be realized by a deformation of (η_t, f_t) which keeps (η_0, f_0) and (η_1, f_1) fixed.

(0.1) Uniqueness of birth. See Chap. III, §1 of [3]. For $0 \leq i \leq n$

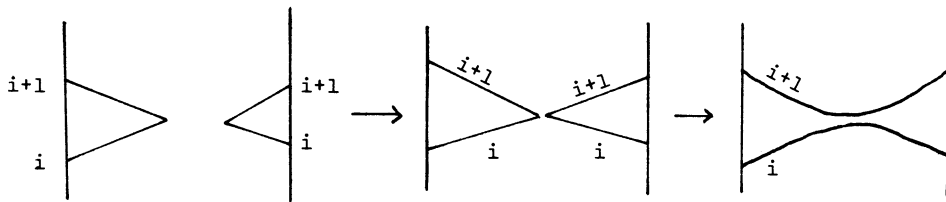

(0.2) Dovetail. See [5, Chap. 2]. For $0 \leq i \leq n - 3$

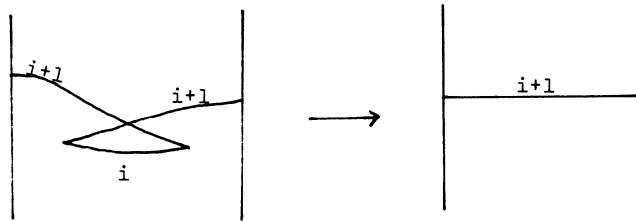

(0.3) Introducing a beak. See [3; Chap. IV, §3]. For $j < n + 1$

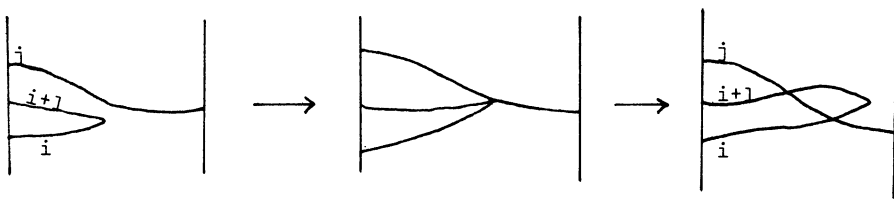

For $0 < j$

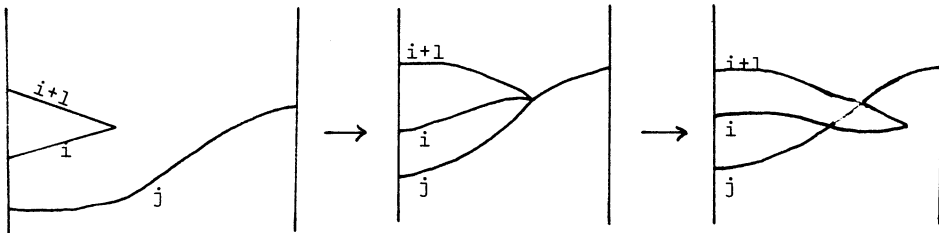

The proof of (0.3) is actually an application of independence of birth-death points and the independent trajectories lemma in Chap. I.

(0.4) Unicity of death.

Suppose (η_t, f_t) has a graphic like

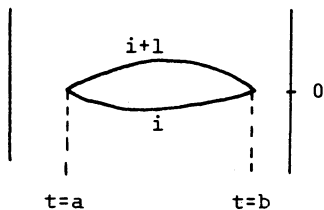

Suppose for $a < t < b$ that the stable and unstable manifolds of the two critical points of f_t intersect transversely in exactly one point in the level surface $f_t^{-1}(0)$. Then

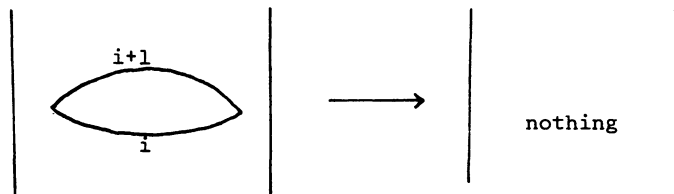

Remark 1. In (0.4) if the birth-death points of f_a and f_b are independent of other critical points (not indicated on the graphic) this independence can be maintained throughout the deformation.

Remark 2. If $V = M^n \times I$ and $\pi_1 M = 0$, then (η_t, f_t) can be deformed so that the hypothesis of (0.4) becomes satisfied provided $i = 0$, $i = n$, or $2 \leq i \leq n - 2$ and $n \geq 5$. Hence under these conditions unicity of death holds. See [3; Chapter III; §2].

When $\pi_1 M \neq 0$ there is an obstruction to unicity of death and in fact this gives rise to the second obstruction $Wh_1(\pi_1 M; \mathbb{Z}_2 \times \pi_2 M)$ for the pseudo-isotopy problem as will be explained in [12] and in Chapter VII below.

§1. Cancelling Critical Points.

Recall the original cancellation lemma of Smale: Let the morse function $f: W \rightarrow I$ have two critical points c and c' of index i and $i+1$ respectively which are consecutive, i.e., $f(c) < f(c')$ and there are no other critical values between $f(c)$ and $f(c')$. If f has a gradient-like vector field for which the transverse intersection of the stable manifold of c' with the unstable manifold of c consists of exactly one trajectory from c to c' , then the two critical points c and c' can be cancelled.

This has the following generalization to m -parameter families $f_t: W \rightarrow I$, $t \in I^m$. Suppose for a subregion $D^k \times D^{m-k}$ of the parameter domain that f_t has two consecutive nondegenerate critical points c_t and c'_t of index i and $i+1$ respectively, $t \in \overset{\circ}{D}^k \times D^{m-k}$, which cancel each other above $\partial D^k \times D^{m-k}$, i.e., for $t \in \partial D^k \times D^{m-k}$ $c_t = c'_t$ is a degenerate critical point of birth-death type.

Proposition 1.1. If f_t has a family of gradient-like vector fields for which the transverse intersection of the stable manifold of c'_t with the unstable manifold of c_t consists of exactly one trajectory for each $t \in \overset{\circ}{D}^k \times D^{m-k}$, then c_t and c'_t for $t \in D^k \times \overset{\circ}{D}^{m-k}$ can be cancelled, leaving birth-death points along $D^k \times \partial D^{m-k}$.

DEFORMATIONS OF THE GRAPHIC

Examples:

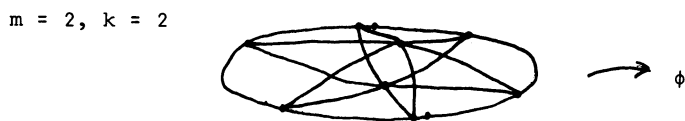
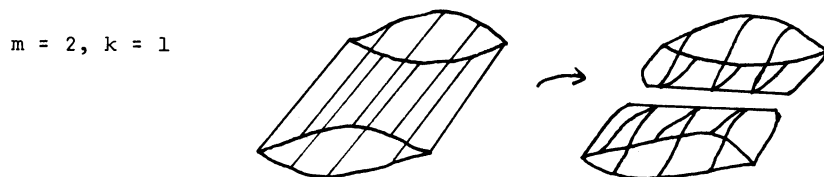
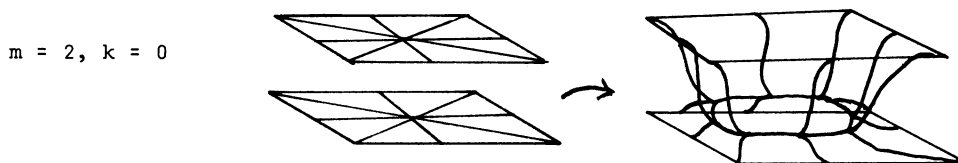
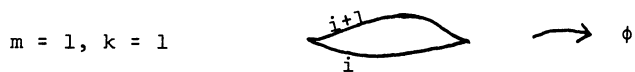
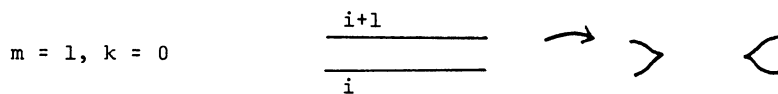

As the picture indicates, smoothing of the corners above $\partial D^k \times \partial D^{m-k}$ is implicit.

The proof of this proposition is essentially contained in Chapter 1 of [5]. A slightly different proof can be constructed as a straight-forward generalization of the proof of Theorem 5.4 of [18].

The question of whether a gradient-like vector field satisfying the hypothesis of the proposition exists is equivalent to whether the intersections $S_{c_t}^i$ and $S_{c_t}^{n-i}$ of the stable and unstable manifolds of a given gradient-like vector field with an intermediate level surface V_t^n can be isotoped in a parameter preserving way so that their transverse intersection $S_{c_t}^i \cap S_{c_t}^{n-i} \subset V_t^n$ is one point for each $t \in D^k \times D^{m-k}$. Near $\partial D^k \times D^{m-k}$ the intersection is already one-point, and isotopies are to preserve this fact.

To measure the obstruction to finding such an isotopy, first note that we may as well assume $k = m$, since an isotopy over the core $D^k \times \{0\}$ extends immediately to all of $D^k \times D^{m-k}$. Also, by isotopy extension we can take the inclusion $S_{c_t}^{n-i} \subset V_t$ to be independent of t . Then the obstruction lies naturally in $\pi_k(\text{Emb}(S^i, V^n), \text{Emb}_0(S^i, V^n))$, where $\text{Emb}(S^i, V^n)$ is the space of embeddings $S^i \subset V^n$ and $\text{Emb}_0(S^i, V^n)$ the subspace of embeddings having a one-point transverse intersection with $S^{n-i} \subset V$.

In a stable range of dimensions we will now "compute" this homotopy group. For a space X let $\Omega_\ell^{\text{fr}}(X)$ denote the framed bordism group in dimension ℓ and let $\pi_\ell^{\text{fr}}(X, *)$ denote the set (group if $\ell > 0$) of framed homotopy classes of framed maps $(S^\ell, *) \rightarrow (X, *)$. Thus $\pi_\ell^{\text{fr}}(X, *)$ splits naturally as $\pi_\ell(X, *) \oplus \pi_\ell^0$.

DEFORMATIONS OF THE GRAPHIC

There is a natural Hurewicz map $H_{\ell}^{\text{fr}}: \pi_{\ell}^{\text{fr}}(X, *) \rightarrow \Omega_{\ell}^{\text{fr}}(X)$ extending the classical J homomorphism $\pi_{\ell}(0) \rightarrow \Omega_{\ell}^{\text{fr}}(*) \subset \Omega_{\ell}^{\text{fr}}(X)$. One can define a relative object $(\Omega, \pi)_{\ell}^{\text{fr}}(X, *)$ to consist of maps of framed ℓ -manifolds $(N, \pi) \rightarrow (X, *)$, with basepoint $*$ $\in \partial N \approx S^{\ell-1}$, with the equivalence relation of framed bordism trivial (i.e., $S^{\ell-1} \times I$) over ∂N and preserving basepoints. If $\ell \geq 2$ $(\Omega, \pi)_{\ell}^{\text{fr}}(X, *)$ is a group with respect to connected sum at $*$ $\in \partial N$. There is a sequence

$$\dots \rightarrow (\Omega, \pi)_{\ell+1}^{\text{fr}}(X, *) \xrightarrow{\partial} \pi_{\ell}^{\text{fr}}(X, *) \xrightarrow{H_{\ell}^{\text{fr}}} \Omega_{\ell}^{\text{fr}}(X) \rightarrow (\Omega, \pi)_{\ell}^{\text{fr}}(X, *) \xrightarrow{\partial} \dots$$

which is exact, at least when $\ell > 0$. In low dimensions one has $(\Omega, \pi)_0^{\text{fr}}(X, *) \approx \Omega_0^{\text{fr}}(X)$ and $(\Omega, \pi)_1^{\text{fr}}(X, *) \approx \text{coker } H_1^{\text{fr}}$.

Proposition 1.2. There is a map

$$\pi_k(\text{Emb}(S^i, V^n), \text{Emb}_0(S^i, V^n)) \rightarrow (\Omega, \pi)_k^{\text{fr}}(\Omega V, *)$$

which is an isomorphism if $k + 2 < i < n - k - 2$ and is surjective if $k + 2 \leq i \leq n - k - 2$ and $k > 0$.

Proof. The proposition follows easily from 3.1 and 4.2 of [13]. In effect, the intersection $T = S^i \times D^k \cap S^{n-i} \times D^k \subset V^n \times D^k$ determines a bordism class in $(\Omega, \pi)_k^{\text{fr}}(\Omega V, *)$, and the class of ∂T in $\pi_{k-1}^{\text{fr}}(\Omega V, *)$ is the obstruction to choosing for "N" in 4.2 of [13] a disc D^k . If this obstruction vanishes one obtains a closed framed manifold $T \cup_{\partial} D^k$ representing an element of $\Omega_k^{\text{fr}}(\Omega V)$ which is the obstruction to changing the intersection T to D^k . This

latter obstruction is of course only well-defined modulo the image of H_k^{fr} . Having the intersection $T = D^k$ it is then always possible to change the embedding $D^k \subset S^i \times D^k$ by any homotopy; in particular, the intersection can be made one point in each parameter slice.

The proof of 4.2 of [13] shows that any class in $(\Omega, \pi)_k^{fr}(\Omega V, *)$ can be realized as intersection, provided $k + 2 \leq i \leq n - k - 2$.

If $k = 0$ the proposition gives the well-known result that the obstruction for the classical Smale cancellation lemma lies in $\Omega_0^{fr}(\Omega V, *) \approx \mathbb{Z}[\pi_1 V]$, provided $2 < i < n - 2$. For $k = 1$ we have the following:

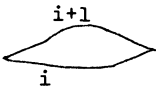
Corollary 1.3. If $3 < i < n - 3$ then a graphic  can be cancelled directly (i.e., by a deformation through graphics of the same type) if and only if an obstruction in

$$\text{coker } H_1^{fr} \approx \frac{(\mathbb{Z}_2 \times \pi_2 V)[\pi_1 V]}{(\mathbb{Z}_2 \times \pi_2 V)[1]} \text{ vanishes.}$$

Proof. Since all the components of ΩV have the same homotopy type, one has $\Omega_1^{fr}(\Omega V) \approx \Omega_1^{fr}(\Omega \tilde{V})[\pi_1 V]$, where \tilde{V} is the universal cover of V . And

$$\Omega_1^{fr}(\Omega \tilde{V}) \approx \Omega_1^{fr}(*) \times \tilde{\Omega}_1^{fr}(\Omega \tilde{V}) \approx \mathbb{Z}_2 \times \pi_2 V \approx \pi_1^{fr}(\Omega V, *) .$$

In Chapter VII it is shown that the restriction $3 < i < n - 3$ can be weakened to $3 \leq i \leq n - 3$ and $n \geq 7$, just as in the case $k = 0$ the hypothesis $2 < i < n - 2$ can be relaxed to

DEFORMATIONS OF THE GRAPHIC

$2 \leq i \leq n - 2$ and $n \geq 5$.

We will have occasion to cancel not only pairs of nondegenerate critical points by using birth-death points, but also pairs of birth-death points using dovetail singularities. This is covered by the following proposition, a proof of which may be found in [5], Chap. 2.

Proposition 1.4.

A) If the one-parameter family $f_t: W^{n+1} \rightarrow I$ with graphic

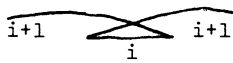

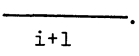
has a gradient-like vector field for which the transverse intersection of the stable manifolds of each of the two critical points of index $i+1$ with the unstable manifolds of the critical point of index i consists of exactly one trajectory in each t slice, then f_t can be deformed through a dovetail singularity so as to change the graphic to .

B) If $i \leq n - 3$ one can always find such a gradient-like vector field.

Here is a sketch of the proof of part B when $n \geq 5$. Starting with an arbitrary gradient-like vector field for the graphic

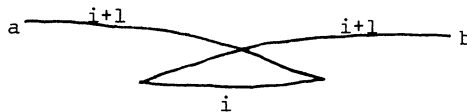

one first slides any $i+1/i+1$ intersections of a over b off to the left of the birth point and any $i+1/i+1$ intersections of b over a off to the right of the death point. Then the stable

manifolds of a and b will run uninterrupted down to level surfaces V_t^n just above the i -handle, which they intersect in spheres $S_t^i(a), S_t^i(b)$. For the transverse spheres $S_t^{n-i} \subset V_t$ of the i -handle one has $S_t^i(b) \cap S_t^{n-i} = (S_t^i(a) \cap S_t^{n-i})$ equal to one point for t slices near the birth (death) point. We wish to extend these one-point intersections to the whole t interval of the i -handle. This is done in two steps. First, by the corollary of Lemma 1.5 below, we can make $S_t^i(b) \cap S_t^{n-i}$ one point except in t slices near the death point and $S_t^i(a) \cap S_t^{n-i}$ one point except in t slices near the birth point. Then in a level surface between a and b the "bad" $i+1/i$ intersections involving a can be slid off to the left of the birth point and those involving b can be slid off to the right of the death point.

Lemma 1.5. Let $H: Q^q \times I \rightarrow M^m$ be an isotopy transverse to $P^{m-q} \subset M$. If $q \leq m - 3$, $m \geq 5$, and the normal bundle of $H_0(Q)$ in M has a section, then H can be deformed rel $Q \times \partial I$ through isotopies to an isotopy H' for which $H'|_{Q \times [0, 1/2]}$ is an embedding and $(H'_t)^{-1}(P) = H_1^{-1}(P)$ if $1/2 \leq t \leq 1$.

Corollary 1.6. With the same hypotheses, any isotopy of $H^{-1}(P)$ in $Q \times I$ fixing $H^{-1}(P) \cap Q \times \partial I$ can be realized by a deformation of H through isotopies fixing $Q \times \partial I$.

A proof of the lemma can be found in [3] Ch. I §5.3.

In analogy with Proposition 1.1, part A of Proposition 1.4 can be extended to $(m+1)$ -parameter families whose graphic contains an m -disc $D^k \times D^{m-k}$ of graphics $\begin{matrix} i+1 & & i+1 \\ & \searrow & / \\ & i & \end{matrix}$, with the

DEFORMATIONS OF THE GRAPHIC

birth-death points being cancelled by dovetail singularities over $\partial D^k \times D^{m-k}$. Part B also holds in this setting for a suitable range of dimensions. For example, a k -parameter version of Lemma 1.5 and Corollary 1.6 can be proved by the techniques of 4.1 of [13] under the hypothesis $q < m - k - 3$. This implies the parametrized version of Part B when $i < n - k - 3$. The case $m = k = 1$ is treated in detail in [5], Theorem 3.2.1.

§2. Introducing Critical Points.

It is also of interest to know under what conditions the process of cancelling critical points described in Propositions 1.1 and 1.4 can be reversed. Thus in the first case one is given a region $D^k \times D^{m-k}$ in the parameter domain and numbers r and ϵ such that in $f_t^{-1}[r-\epsilon, r+\epsilon]$, f_t has no critical points when $t \in D^k \times D^{m-k}$ and a single birth-death point c_t when $t \in D^k \times \partial D^{m-k}$, with $f_t(c_t) = r$. And one seeks to "expand" c_t to a pair of nondegenerate critical points c_t, c_t' over $D^k \times D^{m-k}$ which cancel over $\partial D^k \times D^{m-k}$, as in the hypothesis of Proposition 1.1. In general, there is an obstruction to doing this. For $t \in D^k \times \partial D^{m-k}$ the stable and unstable manifolds of the birth-death point c_t of index i provide at c_t a splitting into subbundles of dimension i and $n - i$ of the tangent bundle τV_t of the level surface $V_t = f_t^{-1}(r)$. (Note that V_t is a manifold which, up to a natural diffeomorphism, is independent of t ; call it V .) Thus one has an element of $\pi_{m-k-1}(G_i(\tau V))$, where $G_i(\tau V)$ is the Grassmannian of i -dimensional subbundles of τV , which is the obstruction to extending the splitting of τV_t over $D^k \times \partial D^{m-k}$ to a splitting over all of $D^k \times D^{m-k}$. This is an obstruction to introducing the desired critical points, and it follows easily from §1.5 of [5] that in fact this is the only obstruction.

In particular, when $m = k$ there is never any obstruction (the result in this case being rather trivial anyhow), and when $m - k = 1$ there is no obstruction if V is connected, since $\pi_0(G_i(\tau V)) \approx \pi_0 V$. The latter case was first handled in Chapter III, §1

of [3]. For pictures of the resulting changes in the graphic in low dimensional cases see the diagrams after Proposition 1.1 (reverse the arrows, of course).

The hypotheses for introducing pairs of nondegenerate critical points in the manner just described can be weakened slightly to allow other critical points in $f_t^{-1}[r-\epsilon, r+\epsilon]$. Since the critical points are introduced in a small neighborhood of an m -parameter family of points $x_t \in f_t^{-1}[r-\epsilon, r+\epsilon]$, $t \in D^k \times D^{m-k}$, with $x_t = c_t$ for $t \in D^k \times \partial D^{m-k}$, it suffices to find the x_t disjoint from other critical points of f_t . This is always possible by general position if $n = \dim V$ is large enough, say $n > 2m - 1$.

Also, the new critical points can be introduced to be independent of all the old critical points, and without disturbing their stable and unstable manifolds, provided the points x_t can be chosen in the complement of these stable and unstable manifolds. Here general position suffices if the indices of the existing critical points lie in the interval $[m+1, n-m]$.

We turn now to reversing the process of Proposition 1.4. One is given an $m+1$ -parameter family containing an $m+1$ -disc $D^k \times D^{m-k} \times D^1$ of critical points which are nondegenerate of index $i+1$ except over $D^k \times \partial D^{m-k} \times \{0\}$, where they are dovetail singularities of index i . Thus one has an m -disc $D^k \times D^{m-k}$ of graphics $\text{---} \overset{i+1}{\text{---}}$ which across $D^k \times \partial D^{m-k}$ become $\text{---} \overset{i+1}{\text{---}} \underset{i}{\text{---}} \overset{i+1}{\text{---}}$

One wants to pass through dovetails over $D^k \times D^{m-k} \times \{0\}$ to produce an m -disc $D^k \times D^{m-k}$ of graphics $\text{---} \overset{i+1}{\text{---}} \underset{i}{\text{---}} \overset{i+1}{\text{---}}$ with dovetail singularities remaining over $\partial D^k \times D^{m-k} \times \{0\}$.

A nondegenerate critical point of index $i+1$ (i.e., of the form $-x_1^2 - \dots - x_{i+1}^2 + \dots + x_{n+1}^2$) determines, via its stable and unstable manifolds, a splitting of the tangent space of the manifold at the critical point into subspaces of dimension $i+1$ and $n-i$. A dovetail singularity of the type $-x_1^4 - x_2^2 - \dots - x_{i+1}^2 + x_{i+2}^2 + \dots + x_{n+1}^2$ such as we are here considering also gives such a splitting. But in addition there is a preferred line in the $i+1$ -dimensional subspace, corresponding to the term $-x_1^4$. Moreover, as one can see from the unfolding of the dovetail singularity which takes place across $D^k \times \partial D^{m-k} \times D^1$, this line has a preferred orientation. The obstruction to extending this oriented line in an $i+1$ -dimensional bundle over $D^k \times \partial D^{m-k} \times \{0\}$ to an oriented line in the $i+1$ -bundle over $D^k \times D^{m-k} \times \{0\}$, which lies in $\pi_{m-k-1}(S^i)$, is an obstruction to introducing the desired critical points. It is not hard to see using the results of Chapter 3 of [5] that this is the only obstruction. In particular, when $m - k - 1 < i$ there is no obstruction.

We shall have occasion to use the trivial case $m = k = 0$, when the change in the graphic is simply



and the case $m = 1, k = 0, i > 0$ which is 3.3.1 of [5]:

DEFORMATIONS OF THE GRAPHIC

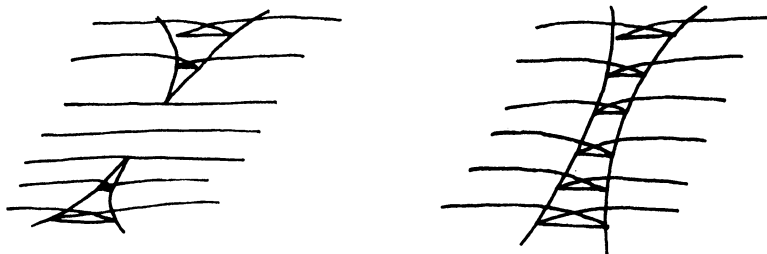

We remark that for introducing critical points by passing through dovetails along a sheet of nondegenerate critical points in this manner the situation is unchanged if other pieces of the graphic intersect the graphic of the sheet of nondegenerate critical points, since everything takes place in a neighborhood of the given nondegenerate critical points.

Question: What are the obstructions for the analogous problems of cancelling and introducing the higher order singularities in the series: birth-death point, dovetail, butterfly, ..., i.e., the singularities whose degenerate part is of the form x^p for some $p > 3$? Do the obstructions always vanish in a suitable stable range, as they do for the case of birth-death points?

§3. Two Indices.

For an h -bordism W^{n+1} let \mathcal{G}_i denote the interior of the closure of the set of morse functions on W having all critical points of index i and $i+1$. If $2 \leq i \leq n - 2$, \mathcal{G}_i is non-empty [18]. The principal result of this section is:

Theorem 3.1. a) If $2 \leq i \leq n - 2$ then $\pi_0 \mathcal{G}_i = 0$. (*)
 b) If $7 \leq i \leq n - 7$ then $\pi_1 \mathcal{G}_i = 0$.

The restriction $7 \leq i \leq n - 7$ can be weakened, but we will not need to do so.

The condition $\pi_k \mathcal{G}_i = 0$ translates into the statement that a $(k+1)$ -parameter family $f_t: W \rightarrow I$, $t \in I^{k+1}$, which over ∂I^{k+1} is a generic k -parameter family having all (nondegenerate) critical points of index i and $i+1$, can be deformed rel ∂I^{k+1} to a generic $(k+1)$ -parameter family all of whose critical points are of index i and $i+1$.

The principal tool in proving the theorem is the following proposition which is a direct but somewhat complicated generalization of the methods of [30]. Let $f_t: W^{n+1} \rightarrow I$ be a generic m -parameter family, $m \leq 2$, whose critical points are ordered as in I §8, and let i be the lowest index of the critical points of f_t .

(*) cf. [5] and [6].

Proposition 3.2. Suppose α_t is a nondegenerate critical point of f_t of index i such that α_t is the only critical point on the level $f_t(\alpha_t)$, $t \in I^k \subset I^m$. Then if $i < n - l - m - 3$, we can introduce a trivial critical point pair (γ_t, β_t) of index $(i+2, i+1)$ over a neighborhood N of I^k so that β_t cancels α_t in N with birth-death points of α_t and β_t remaining on ∂N .

Complement. This can be done preserving all α_t/j intersections outside N . If $j \leq i + 1$ we can preserve j/α_t intersections outside N and have no j/β_t intersections (other than γ_t/β_t) near ∂N .

We begin the proof with a technical lemma. Let $M_t^+(M_t^-)$ be a level surface just above (below) α_t , so that α_t is the only critical point between M_t^+ and M_t^- . By isotopy extension we can assume $M^+ = M_t^+(M^- = M_t^-)$ is independent of t . Then let W_1 be the part of W below M^- , W_2 the part above M^- , and W_3 the part above M^+ :

$$W \left\{ \begin{array}{l} \text{---} \\ M^+ \\ \alpha_t \\ M^- \\ \text{---} \end{array} \right\} \left. \begin{array}{l} \\ W_2 \\ \\ W_1 \end{array} \right\} W_3$$

Let D^i be the stable, D^{n+1-i} the unstable manifold of α_t between M^- and M^+ , with $S^{i-1} = D^i \cap M^-$, $S^{n-i} = D^{n+1-i} \cap M^+$. Finally, let k be the highest index of critical points below α_t .

Lemma 3.3. If $i \leq n - 2$ and $k \leq n - 2$ then the pair $(W_3, M^+ - S^{n-i})$ is i -connected.

Proof of Lemma: Since there are no handles of index $< i$, $(W_1, \partial W)$ is $(i-1)$ -connected. From the exact sequence of the triple $(W, W_1, \partial W)$ and the fact that $(W, \partial W)$ is ∞ -connected, we conclude that (W, W_1) is i -connected. A proof of the following elementary fact may be found in [30]:

Fact: Let B and C be CW complexes intersecting in a common subcomplex. If $B \cap C \subset C$ induces an isomorphism of fundamental groupoids, the pairs $(B, B \cap C)$ and $(B \cup C, C)$ have the same connectivity.

We apply this to $B = W_2$, $C = W_1$, to conclude that (W_2, M^-) is i -connected. The condition on fundamental groupoids is satisfied if $n - 2 \geq k$, for since there are no dual handles of index $< n-k+1$ in W_1 , (W_1, M^-) is $(n-k)$ -connected.

Next we examine the exact sequence of the triple $(W_2, (W_2 - D^i) \cup M^-, M^-)$. Since $(W_2, (W_2 - D^i) \cup M^-)$ is n -connected and $i < n$, $((W_2 - D^i) \cup M^-, M^-)$ is also i -connected.

Now apply the Fact again with $B = W_2 - D^i$, $C = M^-$ to obtain that $(W_2 - D^i, M^- - S^{i-1})$ is i -connected if $(M^-, M^- - S^{i-1})$ is 2-connected, which is the case if S^{i-1} has codimension ≥ 3 in M^- , i.e., $n - 2 \geq i$.

Finally, note that $(W_3, M^+ - S^{n-i})$ is a deformation retract of $(W_2 - D^i, M^- - S^{i-1})$, hence is i -connected.

Note that since $k \leq i + m$, the condition $i \leq n - k - n - 2$ implies $k \leq n - 2$.

Proof of the Proposition 3.2. Let D^- be a small i -disc transverse to S^{n-i} . This determines an element of $\pi_1(W_3, M^+ - S^{n-i})$ which is zero by the lemma. Thus there is $g: D^{i+1} \rightarrow W_3$ with $\partial D^{i+1} = D^+ \cup D^-$, $g|D^- = D^-$, and $g|D^+$ mapping to $M^+ - S^{n-i}$. By isotopy extension we may assume the embedding $S^{n-i} \subset M^+$ is independent of the parameter t , so that g extends to a map g_t in each t -slice satisfying $g_t|D^- = D_t^-$ and $g_t|D^+$ mapping to $M_t^+ - S_t^{n-i}$.

The remainder of the proof will be devoted to showing that g_t can be improved so that, for suitable concentric $i+1$ -discs $D_1 \subset D_2 \subset D_3 \subset D_4 = D^{i+1}$,

1. $g_t(D_4)$ is disjoint from the critical points of f_t
2. $g_t|D_1$ is an embedding in a level surface M_t above M_t^+
3. $g_t|D_2 - D_1$ is an isotopy of $g_t|\partial D_1$ in M_t
4. $g_t|D_3 - D_2$ is an isotopy obtained by following trajectories of the gradient-like vector field of f_t from $g_t(\partial D_2) \subset M_t$ down to $g_t(\partial D_3) \subset M_t^+$.
5. $g_t|D_4 - D_3$ is an isotopy in M_t^+ of the embedding $g_t|\partial D_3$ to an embedding $g_t|\partial D_4$ which intersects S_t^{n-i} transversely in one point.

Having such a g_t , the proof of the proposition goes as follows. Introduce a trivial $(i+2, i+1)$ -critical point pair (γ_t, β_t) just above the level M_t for t near I^k . Using $g_t|D_2$, deform the vector field above M_t so that $g_t|\partial D_2$ is the intersection of the stable manifold of β_t with M_t . By condition 4, this stable

manifold runs all the way down to M_t^+ , so β_t can be lowered to just above M_t^+ . Then using $g_t|_{D_4 - D_3}$ the vector field can be deformed above M_t^+ so that $g_t(\partial D_4)$ is the part of the stable manifold of β_t in M_t^+ , and by condition 5, β_t can then cancel α_t near I^k .

We now turn to conditions 1-5. Since the critical points of an m -parameter family are of dimension m , general position suffices for 1 provided $i < n - m$.

To achieve 2-4 we begin by pushing $g_t(D^{i+1})$ as far down trajectories of the vector field as general position will allow. Let M_t^q be a family of level surfaces lying above M_t^+ and above the closure of the set of critical points of index $\leq q$, with W_t^q being the part of W between M_t^+ and M_t^q . Then since the general position intersection of the family $g_t(D^{i+1})$ with the unstable manifolds of critical points of index j is of dimension $i + \ell + 1 - j$, we can push g_t down trajectories so that $g_t(D^{i+1}) \subset W_t^{i+\ell+1}$ and so that except near a subset of I^k of dimension r , $g_t(D^{i+1}) \subset W_t^{i+\ell-r}$. Thus there are level surfaces M_t in $W_t^{i+\ell+1}$, with W_t the part of W between M_t^+ and M_t , so that $g_t(D^{i+1}) \subset W_t$ and so that M_t lies in $W_t^{i+\ell-r}$ except near a subset of I^k of dimension r .

Next let $A_t(B_t)$ be the inverse image under g_t of the unstable (stable) manifolds of critical points in W_t , $A = \bigcup_{t \in I^k} A_t$, $B = \bigcup_{t \in I^k} B_t$. Let $C(A_t)$ be the cone on A_t with vertex the center of D^{i+1} and let $C(A) = \bigcup_{t \in I^k} C(A_t)$. (Consider A, B , and $C(A)$ as lying in $D^{i+1} \times I^k$.)

Claim: In general position $C(A) \cap B = \emptyset$ provided $i < n - \ell - m - 3$. To prove this we need only make $g_t(C(A_t))$ disjoint from the stable manifolds of critical points in $W_t^{i+\ell-r+1}$ over an r -dimensional subset of I^ℓ for $0 \leq r \leq \ell$. The critical points in $W_t^{i+\ell-r-1}$ have index $\leq i + \ell - r + 1 + m$ since f_t is ordered as in I §8. So over an r -dimensional subset of I^ℓ these stable manifolds have dimension $\leq i + \ell + m + 2$. If $\dim C(A) \leq \ell + 2 < \text{codim } B = n + 1 + \ell - (i + \ell + m + 2)$, or $i < n - \ell - m - 3$, then in general position $C(A) \cap B = \emptyset$.

With $C(A) \cap B = \emptyset$ then near $C(A)$ we can push g_t up trajectories to M_t . Let $\Sigma g_t = \{(x, t) \in D^{i+1} \times I^\ell \mid g_t \text{ is not an embedding at } x\}$. Then if $\dim C(A) \leq \text{codim } \Sigma g_t$, i.e., $\ell + 2 \leq n = i - 1$ or $i < n - \ell - 2$, in general position g_t will immerse a neighborhood D_t of $C(A_t)$ in M_t with at most isolated double points in isolated t slices. Moreover, these double points may be assumed to lie all in distinct concentric spheres in $\overset{\circ}{D}_t$. Since we can assume D_t is independent of t , $g_t|_{D_t}$ provides $g_t|_{D_2}$ as in conditions 2 and 3. One obtains $g_t|_{D_3}$ immediately by sliding down trajectories from $g_t(\partial D_2) \subset M_t$ to M_t^+ , using the fact that $C(A) \subset \overset{\circ}{D}_2$. Also, there is no obstruction to pushing $g_t|_{D_4 - D_3}$ down trajectories to M_t^+ , where it provides a homotopy from the embedding $g_t|_{\partial D_3}$ to $g_t|_{\partial D_4} = \partial D^{i+1}$ which has the desired one-point intersection with S_t^{n-i} . To get an isotopy from this homotopy one applies the following lemma.

Lemma 3.4. Let Q^q and M^m be manifolds fibered over some manifold and let $i: Q \rightarrow M$ be a fiber preserving embedding which is

disjoint from a subcomplex $K^k \subset M$. Suppose i is fiber homotopic to a map f transversal to a subbundle $P^p \subset M$ with $f(Q) \cap P = N$. If $m > q + p/2 + 1$ and $2m > p + q + k + 2$, then i is fiber isotopic in $M - K$ to an embedding intersecting P in N .

When $K = \phi$ this lemma is Theorem 4.1 of [13]. The proof there readily extends to the present case.

To apply the lemma to the family of homotopies $g_t|_{D_4 - D_3}$ (and hence to finish the proof of the proposition) we need $n + \ell > i + \ell + \frac{1}{2}(n - i + \ell) + 1$, or $i < n - \ell - 2$. For K we choose the intersection of the stable manifolds of critical points of index $\leq i+1$ with M_t^+ , $t \in I_t^\ell$ which is of dimension $\leq i+\ell$. The restriction $2m > p + q + k + 2$ also reduces to $i < n - \ell - 2$, and $g_t|_{\partial D_3}$ is disjoint from K by the proof of the claim above. This choice of K guarantees that the conditions of the Complement will be satisfied.

Proposition 3.2 . When $m = 1$, the condition $i < n - \ell - m - 3$ in Proposition 3.2 can be replaced by $i < n - \ell - 2$.

To establish this the only doubtful point is the claim about $C(A) \cap B$ being empty. When $m = 1$ the level surface M_t below which $g_t(D^{i+1})$ is to be pushed can be taken to be below birth-death points $\begin{matrix} i+2 \\ i+1 \end{matrix}$. For $g_t(D^{i+1})$ can be pushed off the unstable manifolds of such birth-death points, as these unstable manifolds intersect level surfaces just above the birth-death point in $(n-i)$ -discs. Then the highest critical points in W_t are nondegenerate of index $i + \ell + 1$ at isolated t -slices and (if $\ell = 1$) of index $i + \ell$ for the remaining t -intervals. Thus $C(A) \cap B = \phi$

if $\dim C(A) \leq \ell + 2 < \text{"codim } B" = n + 1 + \ell - (i + \ell + 1) = n - i$,
 or $i < n - \ell - 2$.

That $\pi_0^i = 0$ when $2 \leq i \leq n - 2$ is an immediate consequence of the following:

Proposition 3.5. Let $f_t: W^{n+1} \rightarrow I$ be a one-parameter family on the h -bordism W with i the lowest index of critical points. Suppose f_0 and f_1 have no index- i critical points. Then if $i < n - 2$, by introducing new critical points of index $i+1$ and $i+2$ f_t can be deformed, rel f_0 and f_1 , so as to eliminate all index i critical points.

Proof.

1. Eliminate i/i intersections



According to the previous proposition we can cancel the upper i -handle of an i/i intersection pair in a small neighborhood of the t -slice containing the i/i intersection without introducing any new i/i intersections, provided $i < n - 2$.

2. Cancel a remaining arc of i -handles.

a) Near t -slices containing $\langle \begin{smallmatrix} i+1 \\ i \end{smallmatrix} \text{ or } \begin{smallmatrix} i+1 \\ i \end{smallmatrix} \rangle$ points,



This step breaks the given arc of i -handles up into small enough pieces so that we can assume each piece crosses no other critical points in the graphic. That is, with no i/i intersections, a segment \overleftarrow{i} can be raised above all other i -handles.

b) The remaining segments \overleftarrow{i} .

Case I: $i < n - 3$. Let α_t be the given arc of i -handles, with α'_t either of the $i+1$ -handles connected to α_t at the birth or death points. Now apply the preceding proposition to cancel α_t with an $i+1$ -handle β_t for almost the full length of α_t , up to where the α'_t/α_t intersection is one point in each t -slice:

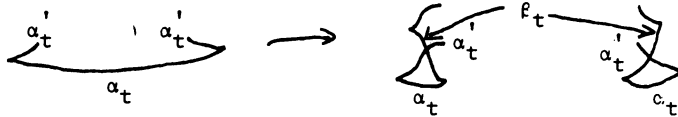

We still have α'_t/α_t intersections one-point in each t -slice, so cancel α'_t with α_t up to $\beta_t >$ or $< \beta_t$ where the β_t/α_t intersection is one point in each t slice.

Now we have a graphic $\overleftarrow{i+1}$ with both $i+1/i$ intersections one point in each t slice, and so by Proposition 1.4 the remaining piece of i -handles can be cancelled:

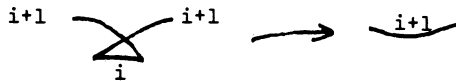

DEFORMATIONS OF THE GRAPHIC

Case II: $i \leq n - 3$. We can apply Proposition 3.2' with $\ell = 0$ to introduce $i+1$ -handles β_t which cancel α_t for a small t interval:

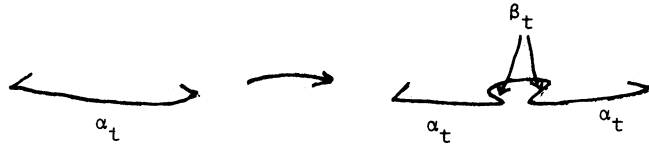

This latter graphic can then be deformed to



and Proposition 1.4 applies to cancel the two remaining segments of α_t .

With the following proposition the main theorem of this section will be complete.

Proposition 3.6. Let $f_t: W^{n+1} \rightarrow I$ be a two-parameter family on the h -bordism W , i.e., $t \in D^2$, with i the lowest index of critical points. Suppose $f_t, t \in \partial D^2$, has no index- i critical points. Then if $i < n - 7$, by introducing new critical points of index $i+1$ and $i+2$ f_t can be deformed, rel $f_t, t \in \partial D^2$, so as to eliminate all index- i critical points.

Proof. We follow the one-parameter version and cancel i -handles first near isolated phenomena, then near one-dimensional phenomena,

and finally cancel the remaining small 2-discs of i -handles

1. Replace dovetails $i \overset{i+1}{\curvearrowright} i$ by $\overset{i+1}{\curvearrowright} i$.

This is a purely local question. The birth-death points of our given dovetail have trace \vee , i.e., a cusp. On one of the arcs of birth-death points we can pass our two-parameter family through a three-parameter family containing an isolated butterfly singularity (with polynomial x^5) to introduce a pair of dovetails:



One of these dovetails, say the upper one, is of the type $\overset{i+1}{\curvearrowright} i$ and the other is $i \overset{i+1}{\curvearrowright} i$. Now bring the new dove-

tail $i \overset{i+1}{\curvearrowright} i$ in close proximity to the original dovetail:



The two dovetails $i \overset{i+1}{\curvearrowright} i$ then can be cancelled

leaving only a dovetail $\overset{i+1}{\curvearrowright} i$:

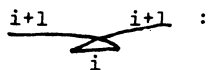

2. Eliminate $i/i+1$ and i/i intersections.

- a) Eliminate $i/i+1$ intersections by cancelling the i -handle in a small neighborhood of the $i/i+1$ intersection.
- b) Eliminate crossings of pairs of i/i intersection arcs by cancelling the top i -handle in a small neighborhood of the crossing point.
- c) Reduce crossings of birth-death arcs with i/i intersection

arcs to the case

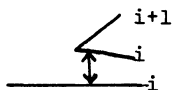

DEFORMATIONS OF THE GRAPHIC

The other possible cases are:

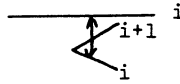
i)  Here we can cancel the upper i -handle near the crossing point.

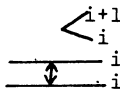
ii)  Cancel the middle i -handle near the crossing point.

d) Eliminate the remaining arcs of i/i intersection ($i < n - 3$). After the preceding three steps a,b,c, we can assume the graphic along the i/i intersection arc is

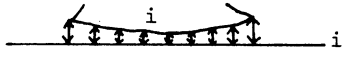
 That is, the upper i -handle arc crosses no other critical points. We are then in the situation of 2.b of the preceding proposition for one-parameter families, and the upper arc of i -handles can be cancelled, first in the interior:



And then in the remaining segments,

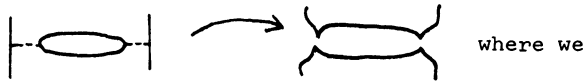

introduce four dovetails



3. Cancel a sheet of i -handles.

a) Near t-slices containing birth-death points of other i-handles

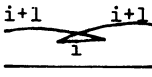
i) Dovetails  . Cancel the given i-handle, which lies below the dovetail.

ii) Crossings of arcs of birth-death points of other

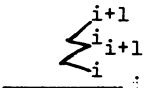
i-handles:  . Again cancel the given i-handle near the crossing point.

iii) The remaining arcs, where the given sheet of i-handles lies below an arc α of birth-death points $\langle \begin{smallmatrix} i+1 \\ i \end{smallmatrix} \rangle$ except perhaps at an end of the arc where the given i-handle is cancelled by an i+1-handle which may lie above the arc α



As in 2.d above, we

cancel the given i-handle first in the interior of

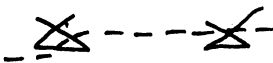
the arc  and then,

after reordering the birth-death arc α if necessary,

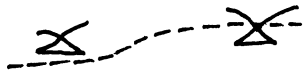

cancel the remaining

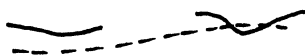

segments, producing four dovetails.

DEFORMATIONS OF THE GRAPHIC

- b) Break what remains of the given sheet of i -handles into discs, e.g., an annular region of i -handles becomes



as in 2.d.

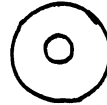

- c) Cancel the remaining discs of i -handles

- i) Near the isolated points where the given i -handles are cancelled by an $i+1$ -handle which is simultaneously the upper $i+1$ -handle of an $i+1/i+1$ intersection,

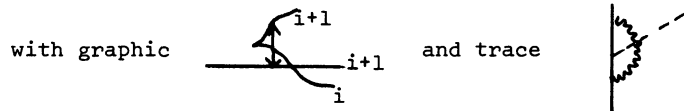

(The wavy line indicates the crossing of the given i -handle with the lower $i+1$ -handle in the graphic.) Here we may cancel the i -handle just below the lower $i+1$ -handle,

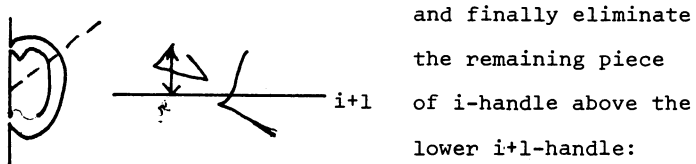
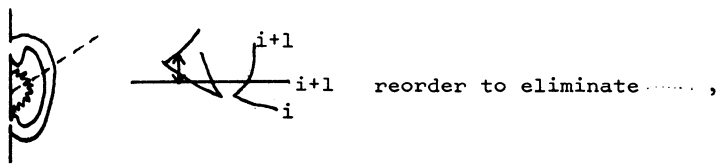

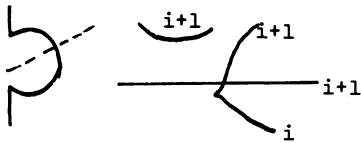

This last step can be done either directly (since $i+1/i$ intersections are right) or by the following three steps.

We can now assume the given disc of i -handles crosses no other handles in the graphic.

ii) Cancel the interior of the disc of i -handles, e.g.,



iii) Cancel near the interior of the birth-death arcs, e.g.,



iv) Translate the index of the remaining triangles ∇ of i -handles to triangles \triangle of $i+2$ -handles by elliptic singularities as explained in Lemma 4.1 of the next section.

§4. The Butterfly and the Elliptic Umbilic.

In section 3 we made use of two of the three kinds of codimension three singularity, the butterfly and the elliptic umbilic. We shall give here brief descriptions of these two singularities. For an account of the hyperbolic umbilic see [5], Chapter IV.

The degenerate part of the butterfly singularity is the polynomial x^5 , with universal unfolding $t_1x + t_2x^2 + t_3x^3 + x^5$. This singularity effects the following change in two-parameter families:

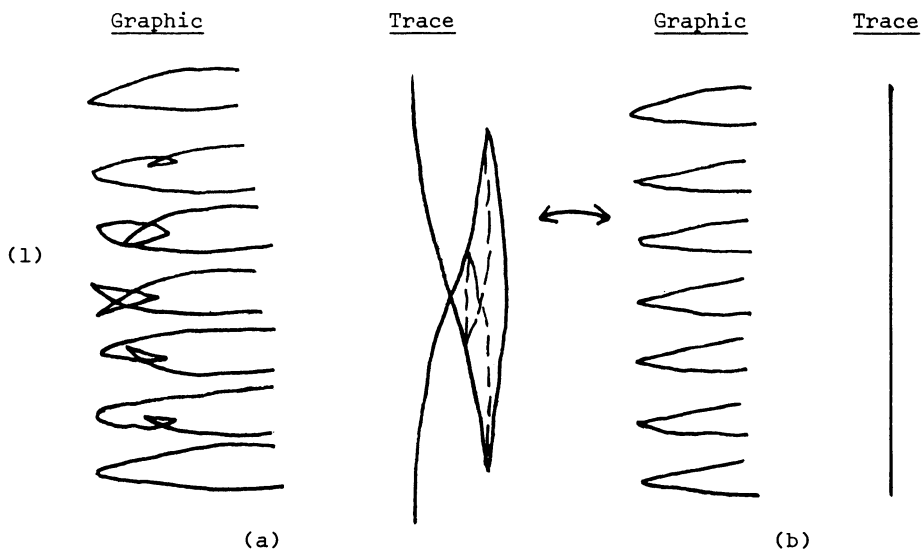

Here the solid lines in the trace represent birth-death points and the dashed lines represent crossings in the graphic. The change from (a) to (b) is made by just shrinking all the complications of

(a) to a point. Notice that the change in the trace of the birth-death points is the same as the change in the graphic at a dovetail in a two-parameter family (turned on edge): 

Thus the effect of a butterfly singularity is to introduce or cancel a pair of dovetail singularities, one of each kind involving the

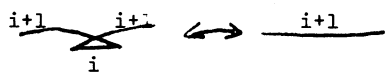
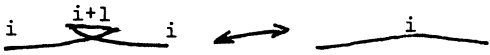
two indices i and $i+1$:  and 

The degenerate part of the elliptic umbilic is the singularity at $(0,0)$ of the function $x^3 + xy^2$. The graph of this function is sometimes called the "monkey saddle":

(2)

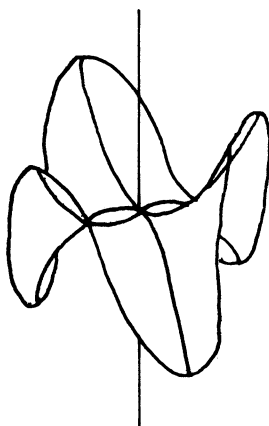

DEFORMATIONS OF THE GRAPHIC

The universal unfolding is a three-parameter family of the form $x^3 + xy^2 + t_1(x^2 + y^2) + t_2x + t_3y$. The trace of this three-parameter family is:

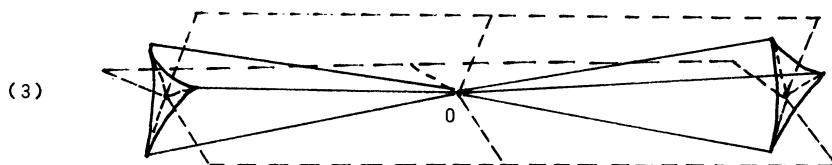

The elliptic umbilic itself lies at the central vertex 0. In a vertical plane section on either side of 0:

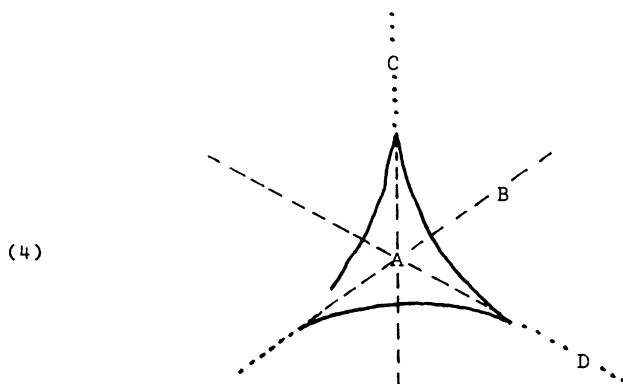

the solid lines correspond to birth-death points (with dovetails at the three cusps), the dashed lines to crossings, and the dotted lines to 1/1 intersections. The letters A,B,C,D refer to the following sample functions, shown in wide-angle view: (the subscript on A denotes the index of the central critical point):

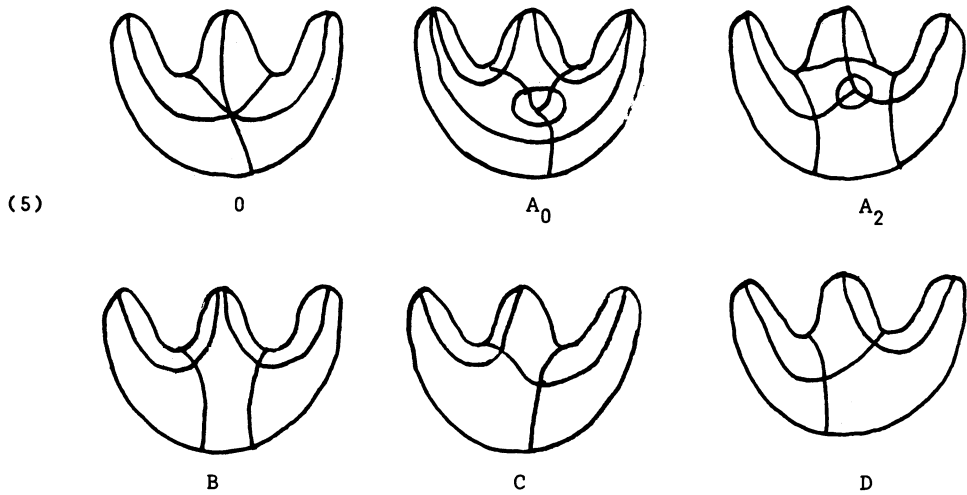

In terms of graphics we have the following one-parameter slices:

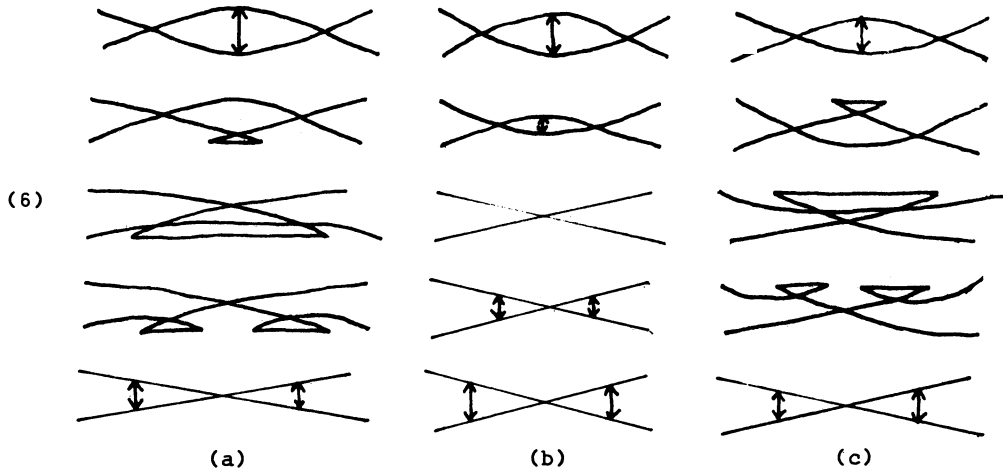

DEFORMATIONS OF THE GRAPHIC

Thus the effect of passing through an elliptic umbilic is to exchange a triangle of critical points of index 0 for a triangle of critical points of index 2. Notice that in each of these triangles the 1/0 or 2/1 intersections of each of the three critical points of index 1 with the critical point of index 0 or 2 consist of exactly one point in each parameter slice.

Lemma 4.1. Let $f_t, t \in D^2$, be a two-parameter family with graphic as in (6.a) above with critical points of index i and $i+1$. Suppose the $i+1/i$ intersections for each of the critical points of index $i+1$ consist of exactly one point in each t slice. Then f_t may be deformed, staying fixed over ∂D^2 , to a two-parameter family with graphic as in (6.c) and with critical points of index $i+1$ and $i+2$.

Proof. The lemma states that in figure (3) it is possible, under the one-point intersection hypothesis, to move a vertical plane section from one side of 0 to the other. Rather than do this directly, we first deform the plane section to look like:

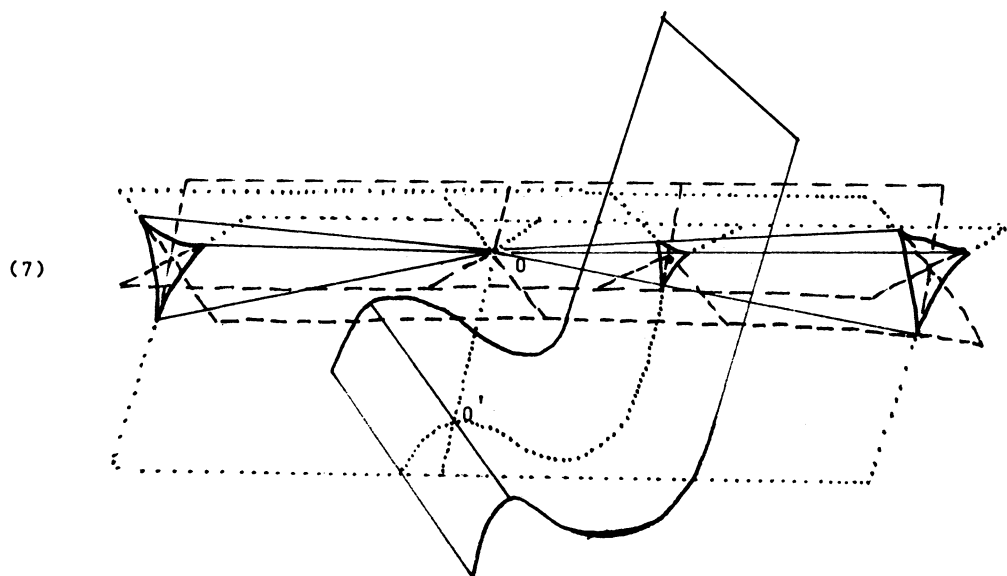

(The one-point intersection hypothesis guarantees that there will be arcs of $i+1/i+1$ intersections emanating from the three dovetails in the given graphic.) Then by translating this curved two-dimensional section upward along the line $0'0$ we can bring about the desired deformation of f_t . Some stages along the way have traces as in (8) below. The advantage of this indirect deformation is that it reduces the use of the elliptic umbilic to the step (a)-(b), which is easy. The crucial steps (b)-(c), (d)-(e), and (e)-(f) are all justified by the results of V §1, since the one-point intersection property is preserved throughout.

DEFORMATIONS OF THE GRAPHIC

(8)

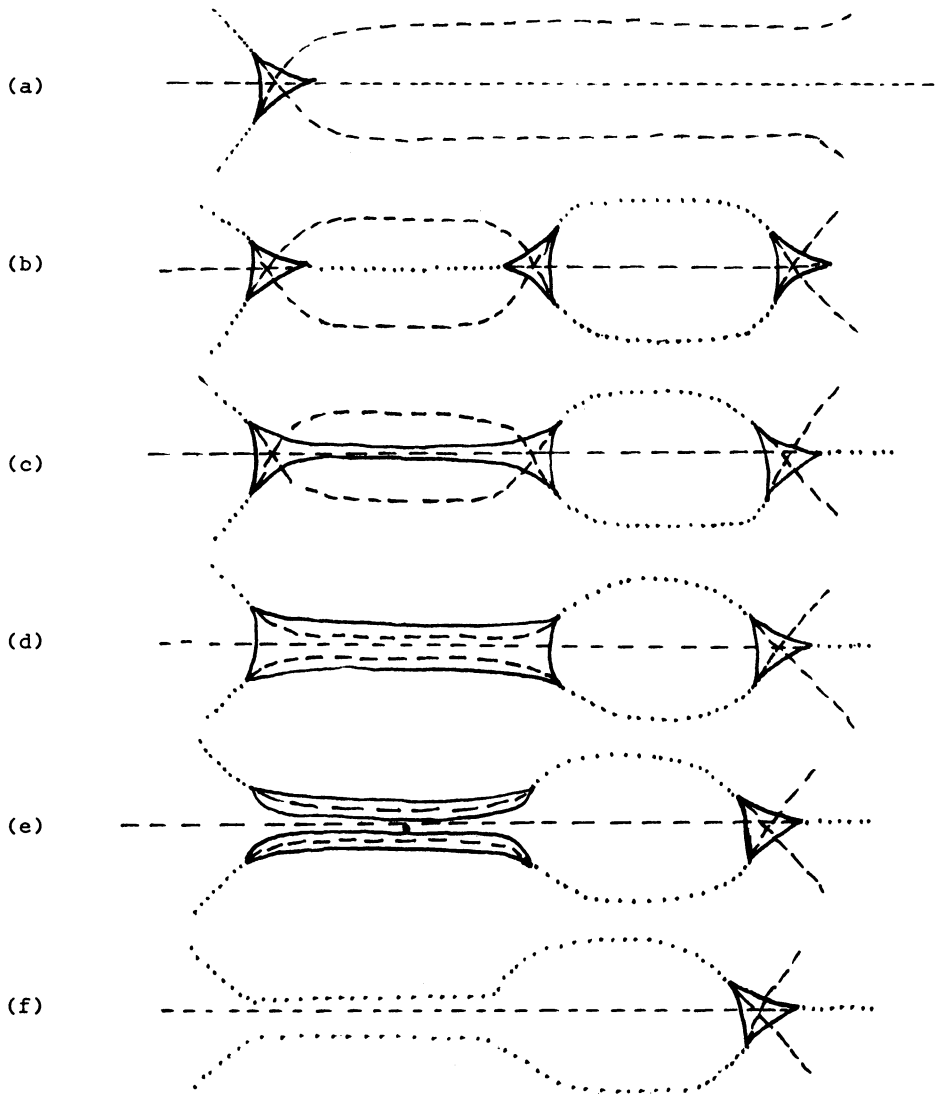

§5. Eliminating all Dovetails.

Let $f_{tu}: M \times I \rightarrow I$, $(t,u) \in I \times I$, represent a homotopy between two representatives f_{t_0} and f_{t_1} of the same class in $\pi_1(\mathcal{F}, \mathcal{K})$, so that f_{0u} and f_{1u} have no critical points. Assume the (nondegenerate) critical points of f_{tu} are all of index i and $i+1$. In this brief section we show that, with an additional mild restriction on f_{t_0} and f_{t_1} , all the dovetail singularities of the two-parameter family can be eliminated.

In the graphic of a one-parameter family f_t which has critical points only of index i and $i+1$, with f_0 and f_1 having no critical points, the set of arcs corresponding to $i+1$ -handles has a natural permutation π , obtained as follows: An arc α of $i+1$ -handles is connected at its birth point to an arc α' of i -handles. In turn, α' is connected at its death point to the arc $\pi(\alpha)$ of $i+1$ -handles. We call π the permutation associated to f_t .

Proposition 5.1. If the permutations associated to f_{t_0} and f_{t_1} are of the same parity and $0 < i < n$, then f_{tu} can be deformed, staying fixed over $\partial(I \times I)$ and preserving the index range $[i, i+1]$, to a (generic) two-parameter family having no dovetail singularities.

Proof. First replace all dovetails $\begin{array}{c} i \quad i+1 \\ \text{---} \end{array}$ by

$\begin{array}{c} i+1 \quad i+1 \\ \text{---} \\ i \end{array}$, as in the first step of the proof of Proposition 3.6.

DEFORMATIONS OF THE GRAPHIC

Next we observe that any two of the remaining dovetails can cancel each other. For, by a simple extension of 3.1.1 of [5],* this can be done if the two dovetails occur in the same sheet of $i+1$ -handles. But by "uniqueness of birth" any two sheets of $i+1$ -handles can be connected since the underlying manifold is connected (see §2).

Thus f_{tu} may be assumed to have at most one dovetail. Our hypothesis on the permutations associated to f_{t0} and f_{t1} will guarantee that f_{tu} has an even number of dovetails and the proof will be complete.

As u varies, the changes in the graphic of f_{tu} which affect the associated permutation π are of three types:

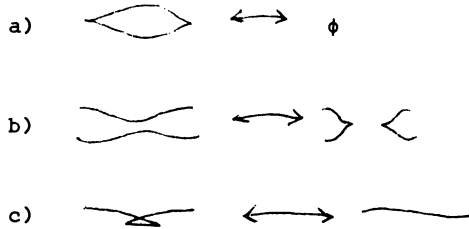

It is easy to see that a) and b) preserve the parity of π while c) reverses it. So if f_{t0} and f_{t1} have permutations of the same parity, f_{tu} must have an even number of dovetails.

*See §2 above, p. V. 16.

§6. The Two-Index Definition of Σ .

The definition of the Wh_2 invariant Σ in the general case that critical points of all indices are present requires some fairly heavy algebraic machinery. If one uses the geometric results of this chapter the algebra can be considerably streamlined by defining Σ only in the two-index case. We indicate briefly how this is done. In this section we use right modules over $Z[\pi_1 M]$.

Let $f_t: M \times I \rightarrow I$ be a generic, ordered one-parameter family all of whose nondegenerate critical points are of index i or $i+1$, and let f_t be provided with a nice gradient-like vector field in general position for which the birth-death points of f_t are independent. Choose an ordering, orientations for the stable manifolds, and paths to a fixed basepoint for the arcs of critical points of index $i+1$. Specifying that the algebraic $i+1/i$ intersection number of a birth pair be $+1 \in Z[\pi_1 M]$ determines similar choices for the arcs of critical points of index i . Then in t slices not containing $i+1/i+1$ or i/i intersections there is defined the algebraic $i+1/i$ intersection matrix in $GL(Z[\pi_1 M])$. (We consider that prior to its birth or after its death an $(i+1, i)$ pair has the same $i+1/i$ intersection number as at its birth or at its death.)

Near $t = 0$ this algebraic $i+1/i$ intersection matrix is the identity matrix. As t passes an i/i (resp. $i+1/i+1$) intersection the matrix changes by right (resp. left) multiplication by an elementary matrix e_{jk}^σ for some $\sigma \in \pm\pi_1 M$ and suitable j and k .

DEFORMATIONS OF THE GRAPHIC

Near $t = 1$ the matrix is of the form $P \cdot D = (\text{permutation}) \cdot (\text{diagonal with entries in } \pm \pi_1 \subset \mathbb{Z}[\pi_1])$. Thus one has $\prod_{\ell} e_{j_{\ell} k_{\ell}}^{\sigma_{\ell}} = P \cdot D$.

By the proof of 1.6 of III, $P \cdot D$ has a representation

$$P \cdot D = \prod_m e_{p_m q_m}^{\tau_m} e_{q_m p_m}^{-\tau_m^{-1}} e_{p_m q_m}^{\tau_m}$$

Then the product

$$\prod_{\ell} \left(\prod_j x_{j_{\ell} k_{\ell}}^{\sigma_{\ell}} \right) \left(\prod_m x_{p_m q_m}^{\tau_m} x_{q_m p_m}^{-\tau_m^{-1}} x_{p_m q_m}^{\tau_m} \right)^{-1}$$

in $\text{St}(\mathbb{Z}[\pi_1])$ lies in $K_2 \mathbb{Z}[\pi_1] \subset \text{St}(\mathbb{Z}[\pi_1])$. Its image Σ_{i+1} in $\text{Wh}_2(\pi_1 M)$ is independent of the representation of $P \cdot D$. It is easy to see that $\Sigma = (-1)^{i+1} \Sigma_{i+1}$ is the Wh_2 invariant Σ defined in IV in this special case where all critical points are of index i and $i+1$.

Rechoosing the ordering, orientations, and paths to the base point for the arcs of critical points affects the algebraic $i+1/i$ intersection matrices as a change of basis by conjugating by suitable products of terms $e_{pq}^{\tau} e_{qp}^{-\tau^{-1}} e_{pq}^{\tau}$. Since K_2 is the center of St , conjugating by the corresponding $x_{pq}^{\tau} x_{qp}^{-\tau^{-1}} x_{pq}^{\tau}$ does not change Σ .

To show Σ is well-defined on $\pi_1(\cdot, \&)$ requires looking at a two-parameter family f_{tu} connecting two choices of f_t as above. Since suspension (see I §5) preserves Σ we can assume that indices and dimensions are large enough to deform f_{tu} into

the two indices i and $i+1$ (V §1). We can also restrict attention to the case that the permutations associated to f_{t_0} and f_{t_1} are both even, so that f_{t_u} may be assumed to have no dovetail singularities, by V, §5. Then birth-death points can be taken to be everywhere independent. Thus one is reduced to showing that the following "catastrophes" preserve Σ :

1. Changes in the graphic

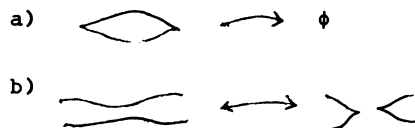

2. Changes in $i+1/i+1$ and i/i intersections

- a) Cancelling or introducing a pair of consecutive $i+1/i+1$ or i/i intersections
- b) Permuting a pair of consecutive $i+1/i+1$ or i/i intersections
- c) $i/i+1$ intersections.

Of these, 1.a) has no effect on Π , 1.b) reduces to the "birth and death relation" of III §2; 2.a) and b) are just the Steinberg relations within Π (see II), and 2.c) is precisely the "exchange relation" of III §2.

CHAPTER VI. The kernel of Σ .

In this section we show that Σ is surjective for $n > 5$ and identify the kernel geometrically as the "uniqueness of death" subgroup.

Consider the set \mathcal{D} of all $[f] \in \pi_0(\mathcal{E})$ such that f can be connected to the standard projection p by a path having a graphic like

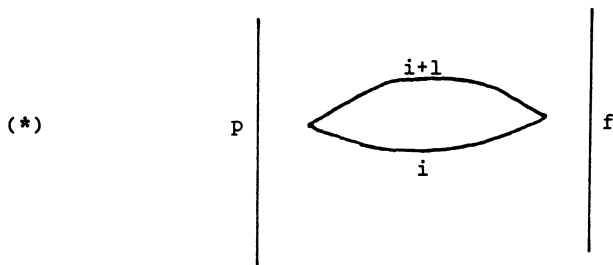

for some $0 < i < n$.

Lemma 1. For $n > 4$ \mathcal{D} is a subgroup, which we will call the uniqueness of death subgroup.

Proof. Suppose $[f]$ and $[g]$ have representatives f and g in \mathcal{E} which are connected to p by paths f_t and g_t having graphics like

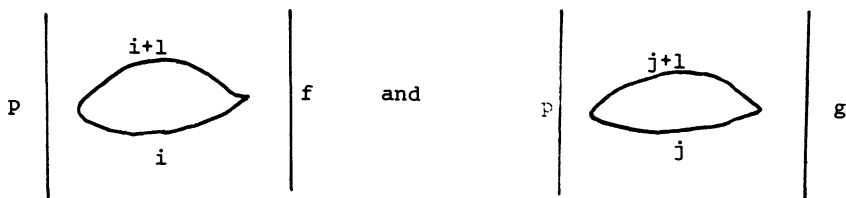

Then $f_t \# g_t$, $0 < t < 1$, has a graphic like

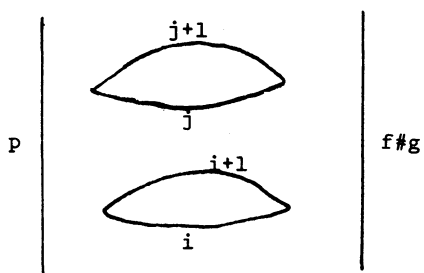

For $n > 4$ the dovetail lemma (0.2) of \mathcal{V} implies that this graphic simplifies to

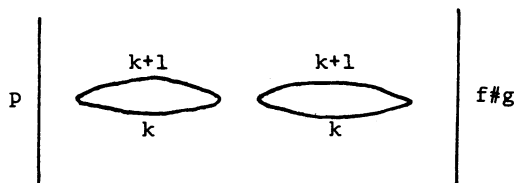

where $2 < k < n - 2$. Now use uniqueness of birth to deform this to

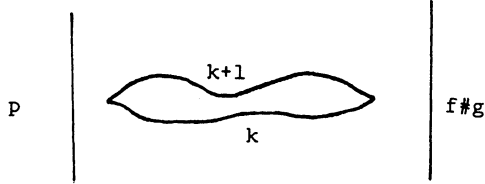

Hence $[f] \cdot [g] = [f \# g] \in \mathcal{L}$ which shows that \mathcal{L} is closed under multiplication.

To show that $[f]^{-1} \in \mathcal{L}$ whenever $[f] \in \mathcal{L}$ write $f = p \circ g$ for $g \in \mathcal{L}$. Let $f_t (0 \leq t \leq 1)$ be a path from p to f with a graphic like (*). Then the path from p to $p \circ g^{-1}$ defined by $f_{1-t} \circ g$ for $0 \leq t \leq 1$ has a graphic like (*) and $[f]^{-1} = [p \circ g^{-1}]$.

Theorem 2. $\Sigma: \pi_0(\mathcal{L}) \rightarrow Wh_2(\pi_1 M)$ is surjective with $\ker \Sigma = \mathcal{A}$ for $n \geq 5$.

The proof of surjectivity is easy. Let $z \in Wh_2(\pi_1 M)$ be represented by the word $\prod x_{\alpha_i \beta_i}(\lambda_i)$ in $K_2(Z[\pi_1 M])$. Using Theorem 1.1 of II construct a path (η_t, f_t) , $0 \leq t \leq 3/4$, from the standard projection to $(\eta_{3/4}, f_{3/4})$, such that each f_t has only critical points of index 2 and 3 and such that $\chi_3(\eta_t, f_t) = \left[\prod x_{\alpha_i \beta_i}(\lambda_i) \right]^{-1}$. Then $\partial_3(\eta_{3/4}, f_{3/4}) = \text{identity}$ and as in the proof of the s-cobordism Theorem [16] we can cancel the critical points of $f_{3/4}$ without introducing any more 3/3 or 2/2 crossings to extend the path to one (η_t, f_t) , $0 \leq t \leq 1$, where $f_1 \in \mathcal{L}$. Then $\Sigma([f_1]) = z \in Wh_2(\pi_1 M)$.

The remainder of this chapter concerns the proof of $\ker \Sigma = \mathcal{A}$. Let $[f] \in \pi_0(\mathcal{A}) = \pi_0(\mathcal{P})$ be in the kernel of Σ . Choose a path $f_t \in \mathcal{F}$ from p to f together with a one-parameter family of gradient-like vector fields η_t for f_t . According to Theorem 3.1 of *V* whenever $n \geq 4$ we can choose (η_t, f_t) so that each f_t has only critical points of index i or $i+1$ for a fixed value $2 \leq i \leq n - 2$. Put the path (η_t, f_t) into general position so that the birth and death points are independent. Unless otherwise stated (η_t, f_t) shall always have these properties in the remainder of this chapter.

Proposition 3. If $\Sigma([f]) = 0$ and $n \geq 4$ then we can eliminate all the $i+1/i+1$ and i/i crossings of (η_t, f_t) by a deformation which preserves independence of birth points.

Proof.

Step 1. Use the independent trajectories lemma (7.1) of *I* together with the beak lemma (0.3) of *V* to deform (η_t, f_t) until all the births occur in the interval $[0, \frac{1}{4})$ and all the deaths occur in the interval $(\frac{3}{4}, 1]$ and so that there are no gradient crossings in these intervals. Also, assume f_t has no critical points for $t \in [\frac{7}{8}, 1]$.

Step 2. Use the exchange lemma (2.2) of §2 in *IV* to eliminate the i/i crossings as in the following example:

THE KERNEL OF Σ

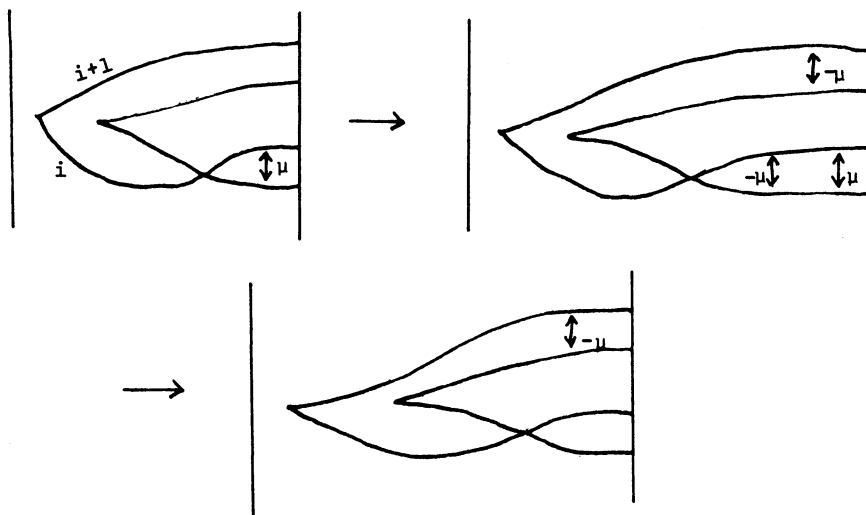

Actually, in case $n = 4$ and $i = 2$, we want to eliminate the $3/3$ crossings with the above method by considering them as $(n+1)-3/(n+1)-3$ crossings of the dual pair $(-\eta_t - f_t)$.

Step 3. Let $x \in \text{St}(Z[\pi_1 M])$ be the word determined by the $i+1/i+1$ crossings of (η_t, f_t) . Since $\Sigma([f]) = 0$ in Wh_2 there is a word $w \in W(\pm\pi_1 M)$ such that $w \cdot x = 1$ in $\text{St}(r, Z[\pi_1 M])$ for some large $r > 0$. Now keeping $(\eta_{\frac{7}{8}}, f_{\frac{7}{8}})$ and (η_1, f_1) fixed deform the path (η_t, f_t) , $\frac{7}{8} < t < 1$, as in (2.7) of IV to introduce a graphic with $i+1/i+1$ crossings which give the word w . Use the uniqueness of birth lemma (0.1 of V) to join the two graphics together as in the following example:

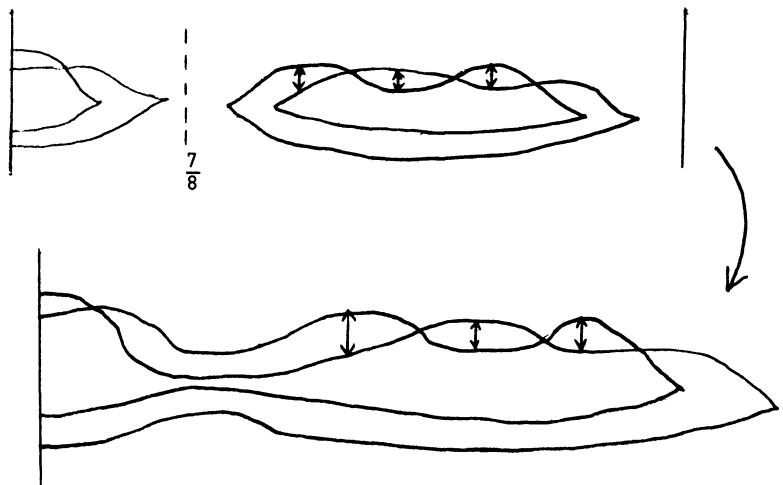

The resulting word determined by the $i+1/i+1$ crossings is $w \cdot x$.

Now introduce trivial graphics of the form

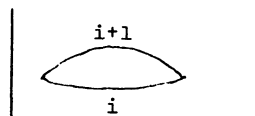

into the diagram so that there are at least r critical points of index $i+1$ and index i . Now if $n > 5$ we can choose the i such that $2 \leq i+1 \leq n - 2$. Apply (1.1) of II to eliminate the $i+1/i+1$ crossings. If $n = 4$ then from Step 2 we only have $2/2$ crossings. These can be eliminated as in Step 3 by introducing the word w into the graphic in the form of $2/2$ crossings.

Q.E.D.

THE KERNEL OF Σ

The following proposition completes the proof of Theorem 2.

Proposition 4. Let $n \geq 5$ and $2 \leq i \leq n - 2$. If (η_t, f_t) has no i/i or $i+1/i+1$ intersections and the birth and death points are independent then (η_t, f_t) can be deformed to have a graphic like

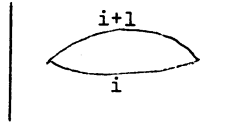

Proof.

By the independent trajectories lemma deform the path (η_t, f_t) so the graphic is

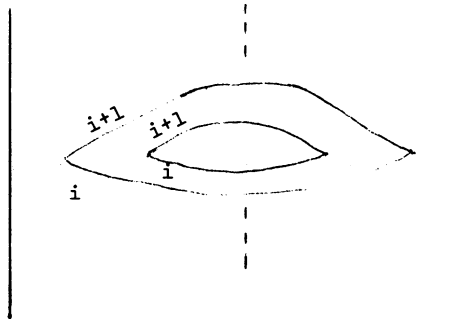

If $i \leq n - 3$ reduce the number of components in the graphic to one by repeating the following process:

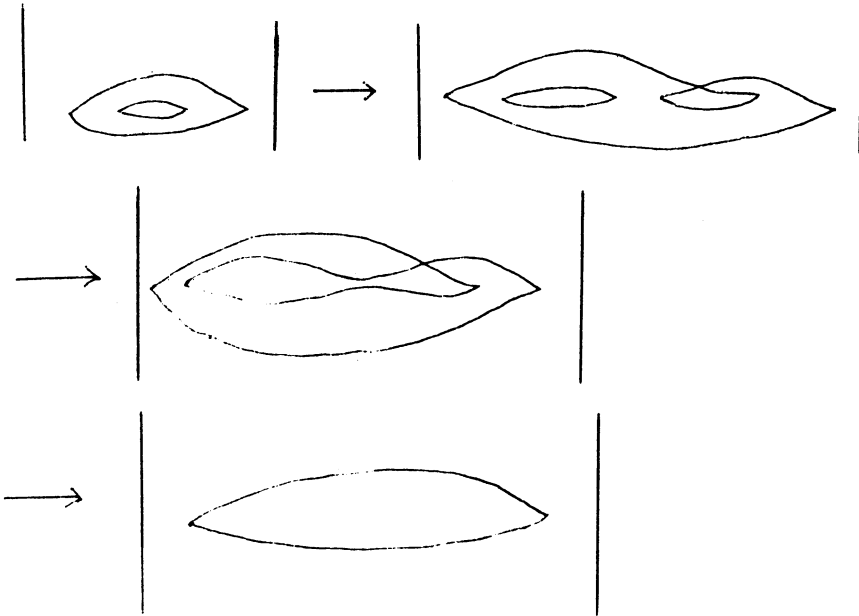

If $i = n - 2$, go through the argument upside down using

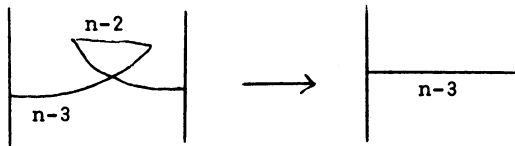

Corollary 5. If $n \geq 5$ and $\pi_1 M = 0$ then $\pi_0(\mathcal{P}) = 0$.

Proof. Since $Wh_2(0) = 0$, Propositions 3 and 4 imply $\pi_0(\mathcal{P}) = \mathcal{A}$, the uniqueness of death subgroup. In the case $3 < i < n - 3$,

 can be cancelled by 1.3 of V. To cancel a graphic

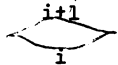
, $2 < i < n - 2$ and $n \geq 5$, one first applies Lemma

2 of VII below to reduce the $i+1/i$ intersections of this pair to a single arc connecting the birth and death points, using $\pi_1 M = 0$. Then by Corollary 1.6 of V, this arc can be straightened out to intersect each t slice in one point, provided $3 \leq i \leq n - 3$, (and hence $n \geq 6$), and the critical points can be cancelled by Proposition 1.1 of V.

The case $n = 5$ requires an extra argument. For if $2 = i = n - 3$, the arc of $i+1/i$ intersections may be knotted in $S^i \times I$, the stable spheres of the i -handles. However, by two careful applications of the Whitney procedure (i.e., embedded surgery on this arc in $S^i \times I$), an "overcrossing" can always be changed to an "undercrossing":



and the arc can be unknotted. See [3], Ch. I §5.3 for more details.

CHAPTER VII. The $Wh_1(\pi_1 M; \mathbb{Z}_2 \times \pi_2 M)$ Invariant.

The second invariant for a pseudo-isotopy is a homomorphism

$$\theta: \pi_0(\mathcal{P}) \rightarrow Wh_1(\pi_1 M; \mathbb{Z}_2 \times \pi_2 M)$$

This section shows how to obtain an element in $Wh_1(\pi_1 M; \mathbb{Z}_2 \times \pi_2 M)$ from any graphic of the form

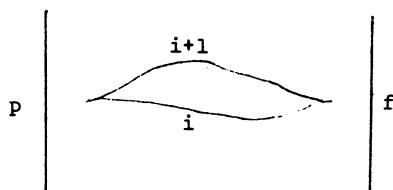

The main problem is to show that this element depends only on $[f] \in \wedge \subset \pi_0(\mathcal{P})$ and not on the choice of path connecting p to f . This will be done in [12].

This chapter shows that when restricted to $\mathcal{S} = \ker \Sigma$ the homomorphism θ is surjective for $n \geq 5$ and injective for $n \geq 7$. Hence we get the main result as stated in the introduction that $\Sigma + \theta$ is surjective for $n \geq 5$ and injective for $n \geq 7$.

Proposition 1. A one-parameter family with graphic

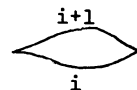

can be deformed to a family with no critical points if an obstruction in $\frac{(\mathbb{Z}_2 \times \pi_2 M)[\pi_1 M]}{(\alpha\sigma - \alpha^T \tau \sigma^{-1}, \beta \cdot 1)}$ vanishes, provided $3 < i \leq n - 3$ and $n \geq 7$.

The $Wh_1(\pi_1 M; \mathbb{Z}_2 \times \pi_2 M)$

Here $(\alpha\sigma - \alpha^\tau\tau\sigma\tau^{-1}, \beta \cdot 1)$ denotes the additive subgroup of the "group ring" $(\mathbb{Z}_2 \times \pi_2 M)[\pi_1 M]$ generated by the elements $\alpha\sigma - \alpha^\tau\tau\sigma\tau^{-1}$ and $\beta \cdot 1$ for $\alpha, \beta \in \mathbb{Z}_2 \times \pi_2 M$ and $\sigma, \tau \in \pi_1 M$, with α^τ denoting the standard action of τ on the $\pi_2 M$ component of α and the trivial action on the \mathbb{Z}_2 component.

When $4 \leq i \leq n - 4$ (and hence $n \geq 8$) this proposition follows immediately from Lemma 4 below and Corollary 1.3 of V. To get the improvement to $n \geq 7$ we must work somewhat harder. The crucial point is Lemma 3.

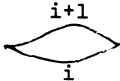
We now give the definition of the second obstruction. To eliminate a graphic  it is necessary that the $i+1/i$ intersection consist of one point in each t -slice. A priori the $i+1/i$ intersection will be only a one-dimensional submanifold $T = S^i \times I \cap S^{n-i} \times I \subset V^n \times I$, V an intermediate level surface. From the local picture at birth-death points we know that ∂T consists of exactly two points, so that T has one D^1 component, connecting the $i+1/i$ intersections at the birth point with those at the death point, plus a number of circle components S_j^1 . We will define for each S_j^1 elements $\sigma_j \in \pi_1$ and $\alpha_j \in \mathbb{Z}_2 \times \pi_2$ so that the total second obstruction is represented by the sum $\sum_j \alpha_j \sigma_j$.

To define σ_j we may assume first, by a suitable choice of paths from a basepoint to $S^i \times I$ and $S^{n-i} \times I$ and orientations for $S^i \times I$ and $S^{n-i} \times I$, that the algebraic intersection number of the handle pair is $+1 \in \mathbb{Z}[\pi_1]$. Each point of transverse intersection of T with a t -slice determines an algebraic intersection number in $\pm\pi_1 \subset \mathbb{Z}[\pi_1]$. If signs are ignored then this intersection

number is well-defined on components of T . Thus S_j^1 has "algebraic intersection number" $\sigma_j \in \pi_1$. The D^1 component of T has algebraic intersection number 1, by assumption.

To define α_j , let C_1 and C_2 be contractions of S_j^1 in $S^i \times I$ and $S^{n-i} \times I$ respectively (we assume $2 \leq i \leq n - 2$ throughout). Then the union $C_1 \cup C_2$ will define the π_2 component of α_j once a homotopy class of paths from S_j^1 to the basepoint is specified by choosing the preferred path from $S^i \times I$ to the basepoint. (Strictly speaking we should also orient S_j^1 , for example by choosing the $+t$ direction at a point of transverse intersection of S_j^1 with a t -slice where the algebraic intersection number is $+\sigma_j$.) The \mathbb{Z}_2 component of α_j is defined as the framed bordism class in $\Omega_1^{fr} \approx \mathbb{Z}_2$ of $S_j^1 \subset S^{n-i} \times I \subset S^{n-i+1}$ with normal bundle $\nu(S_j^1; S^{n-i} \times I) \approx \nu(S^i \times I; V \times I)|_{S_j^1}$ framed via the canonical framing of $\nu(S^i \times I; V \times I)$, namely, the one given by the fact that S^i is the attaching sphere of a handle. Alternatively, we could use the framing of $\nu(S^i \times I; V \times I)|_{S_j^1}$ induced by the contraction C_1 of S_j^1 in $S^i \times I$.

Lemma 2. If two components of T have the same algebraic intersection number in π_1 then they can be joined by surgery into a single component, provided $2 \leq i \leq n - 2$ and $n \geq 5$.

Proof. Suppose S_j^1 and S_k^1 are such that $\sigma_j = \sigma_k$. If S_j^1 intersects a t slice transversely, it does so in two points (at least) with algebraic intersection numbers $+\sigma_j$ and $-\sigma_j$, and likewise for S_k^1 . So after applying Corollary 1.6 of V to

make S_j^1 and S_k^1 meet the same t slice, we can apply the classical Whitney procedure in this t slice to cancel the $i+1/i$ intersection points corresponding to $+\sigma_j$ and $-\sigma_k$. As a one-parameter family this cancellation is in effect a surgery joining S_j^1 to S_k^1 .

Note that the proof also applies when " S_j^1 " is the D^1 component of T and $\sigma_k = 1$.

Lemma 3. An S_j^1 component of T with vanishing $\alpha_j \in \mathbb{Z}_2 \times \pi_2 M$ can be eliminated if $3 < i < n - 3$ and $n \geq 7$.

Proof. We imitate the proof of the Whitney procedure for cancelling pairs of isolated intersection points, as presented for example in [18], Theorem 6.6. Let D^3 be a lens-shaped 3-disc whose boundary consists of two 2-discs D_1 and D_2 intersecting transversely in a circle S^1 :

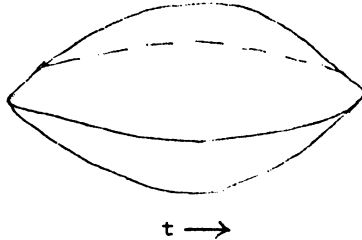

We shall construct a t -parameter preserving embedding

$\mathcal{G}: D^3 \times \mathbb{R}^{i-1} \times \mathbb{R}^{n-i-1} \rightarrow V^n \times I$ with $\mathcal{G}^{-1}(S_j^1) = S^1 \times \{0\} \times \{0\}$,
 $\mathcal{G}^{-1}(S^i \times I) = D_1 \times \mathbb{R}^{i-1} \times \{0\}$, and $\mathcal{G}^{-1}(S^{n-1} \times I) = D_2 \times \{0\} \times \mathbb{R}^{n-i-1}$.
 It is clear from this model how to cancel S_j^1 .

To begin we apply Corollary 1.6 of V to isotope S_j^1 so that its projection onto t is a morse function having only two critical points, with critical values $t_0 < t_1$. To construct $D_1 \subset S^i \times I$ with $\partial D_1 = S_j^1$ we can regard $S_j^1 \subset S^i \times I$ as an isotopy $S_t^0 \rightarrow S^i$ which has given extensions to $D_t^1 \hookrightarrow S^i$ for t near t_0 and t_1 . If $i \geq 2$ this extends to $D_t^1 \hookrightarrow S^i$ for $t_0 < t < t_1$, producing an embedding of a 2-disc $D_1 \subset S^i \times I$ with $\partial D_1 = S_j^1$. If $i \geq 3$ we can assume also that $D_1 \cap T = S_j^1$. Similarly, if $n - i \geq 3$ we can find $D_2 \subset S^{n-i} \times I$ with $D_2 \cap T = \partial D_2 = S_j^1$.

Let η be a framing of $v(S^i \times I, V^n \times I)|_{D_1}$. Then $\eta|_{S_j^1}$ is a framing of S_j^1 in $S^{n-i} \times I$ whose framed bordism class is the $\mathbb{Z}_2 \approx \pi_1 0(n-i)$ component of α_j . If this is zero η can be deformed so that the first vector v of η is the inward normal of S_j^1 in D_2 and so that the remaining $n - i - 1$ vectors extend to a framing η' of D_2 in $S^{n-i} \times I$. Write $\eta = v \oplus \eta'$ over D_1 . Thus η' is a field of $(n-i-1)$ -frames over $D_1 \cup D_2$ which are normal to $S^i \times I$ over D_1 and normal to D_2 in $S^{n-i} \times I$ over D_2 .

The inward normal of S_j^1 in D_1 induces a section of $v(S^{n-i} \times I, V^n \times I)|_{S_j^1}$. If $i \geq 3$ this extends to a section w of $v(S^{n-i} \times I, V^n \times I)|_{D_2}$. Together v and w allow one to push $D_1 \cup D_2$ off $S^i \times I \cup S^{n-i} \times I$. The resulting 2-sphere $S^2 \subset V \times I - (S^i \times I \cup S^{n-i} \times I)$ represents the $\pi_2 M$ component of α_j , which is zero by hypothesis. To construct D^3 we now regard S^2 as an isotopy $S_t^1 \hookrightarrow V - (S^i \cup S^{n-i})$, $t_0 < t < t_1$,

which has given extensions to D_t^2 for t near t_0 or t_1 . This isotopy extends to a homotopy $D_t^2 \rightarrow V - (S^i \cup S^{n-i})$ since

$$\pi_2(V^n - (S^i \cup S^{n-i})) \rightarrow \pi_2(V^n - S^{n-i}) \approx \pi_2(M - S^{i-1}) \rightarrow \pi_2 M$$

is an isomorphism whenever $i \leq n - 4$ (or dually, $i \geq 4$). If $n \geq 6$ general position suffices to make $D_t^2 \rightarrow V - (S^i \cup S^{n-i})$ an isotopy, producing $D^3 \subset V^n \times I$ with $\partial D^3 \doteq D_1 \cup D_2$ as desired.

In $\nu(D^3, V^n \times I)$ η' is now a field of $(n-i-1)$ -frames over ∂D^3 . The obstruction to extending η' to all of D^3 is an element $z \in \pi_2 V_{n-i-1, n-2}$ where $V_{n-i-1, n-2} \approx O(n-2)/O(i-1)$ is the appropriate Stiefel manifold. The group $\pi_2 V_{n-i-1, n-2}$ is zero unless $i = 3$.

If $i = 3$ then we can make $z = 0$ by rechoosing the section w of $\nu(S^{n-i} \times I, V^n \times I)|_{D_2}$. For $\partial(z) \in \pi_1 O(i-1)$ classifies the bundle of $(i-1)$ -planes in $\nu(D^3, V^n \times I)|_{\partial D^3}$ normal to η' . This bundle becomes trivial after stabilizing by adding w , so a suitable choice of w will make $\partial(z) = 0$, and hence $z = 0$ since

$$\pi_2 O(n-2)/O(i-1) \xrightarrow{\partial} \pi_1 O(i-1)$$

is injective.

An extension of η' to a field of $(n-i-1)$ -frames in $\nu(D^3, V^n \times I)$ provides automatically a framing of the remaining $i-1$ normal directions. These framings permit the construction of the required $\mathcal{Q}: D^3 \times \mathbb{R}^{i-1} \times \mathbb{R}^{n-i-1} \rightarrow V^n \times I$.

Proof of Proposition 1. If $\sum \alpha_j \sigma_j = \beta \cdot 1$ for some $\beta \in \mathbb{Z}_2 \times \pi_2 M$ we can reduce T to the D^1 component as follows: First, join all components having the same σ_j , as in Lemma 2. Then any S_j^1 components which remain must have $\sigma_j \neq 1$ and $\alpha_j = 0$. Lemma 3 allows these to be cancelled, leaving only the D^1 component. By Corollary 1.6 of V this D^1 can be straightened out to intersect each t slice transversely in one point, and the graphic can be cancelled.

Remark. The result so far, namely that if $\sum \alpha_j \sigma_j = \beta \cdot 1$ then the graphic can be eliminated, is the main result of Chapter 1 of [6].

To complete the proof of the Proposition it remains only to prove the following:

Lemma 4. A one-parameter family with graphic  and

$i+1/i$ invariant $\sum \alpha_j \sigma_j$ can be deformed to a family with the same graphic and $i+1/i$ invariant $\sum \alpha_j \sigma_j + \alpha \sigma - \alpha^\tau \tau \sigma^{-1}$ for arbitrary $\alpha \in \mathbb{Z}_2 \times \pi_2 M$ and $\sigma, \tau \in \pi_1 M$, provided $3 \leq i \leq n - 2$.

Proof. Near the right end of the original graphic, where the $i+1/i$ intersection is one point in each slice, introduce two circles S_1^1 and S_2^1 of $i+1/i$ intersection with invariants $\alpha \sigma$ and $-\alpha \sigma$, respectively, so that S_1^1 lies to the left of the slice $t = t_0$ and S_2^1 lies to the right. This is done just as in Proposition 5 below. At $t = t_0$ the two critical points can be cancelled, producing a graphic  where the right component

The $Wh_1(\pi_1 M; \mathbb{Z}_2 \times \pi_2 M)$

has $i+1/i$ intersection invariant $-\alpha\sigma$. By rechoosing the path connecting the newly created birth and death points by a factor of $\tau \in \pi_1 M$ and cancelling the new birth and death points along this new path (and thereby returning the graphic to its original form) the $i+1/i$ invariant of S_2^1 will be changed from $-\alpha\sigma$ to $-\alpha^\tau \tau \sigma \tau^{-1}$. The total invariant is then $\sum \alpha_j \sigma_j + \alpha\sigma - \alpha^\tau \tau \sigma \tau^{-1}$.

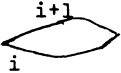
Proposition 5. There is a one-parameter family with graphic  and prescribed $i+1/i$ intersection invariant in $(\mathbb{Z}_2 \times \pi_2 M)[\pi_1 M]$, provided $3 < i < n - 2$.

Proof. When $3 < i < n - 3$ this is a consequence of Proposition 1.2 of V. The following explicit construction allows the improvement to $3 < i < n - 2$.

Let $f_{1/2}: M \times I \rightarrow I$ be a morse function with only two critical points, of index i and $i+1$, and with transverse $i+1/i$ intersection consisting of three points p_1, p_σ , and $p_{-\sigma}$ in an intermediate level surface V^n with intersection numbers $1, \sigma$, and $-\sigma \in \pm\pi_1 M$, respectively. To cancel p_σ and $p_{-\sigma}$ by the Whitney procedure one first joins these two points by arcs $C_1 \subset S^i$ and $C_2 \subset S^{n-i}$ and embeds (if $n \geq 5$) a disc $D^2 \subset V^n$ with $\partial D^2 = C_1 \cup C_2 = D^2 \cap (S^i \cup S^{n-i})$. The choice of D^2 can be altered by any $a \in \pi_2 M$ since the composition

$$\pi_2(V - (S^i \cup S^{n-i})) \rightarrow \pi_2(V - S^i) \approx \pi_2(M - S^{n-i-1}) \rightarrow \pi_2 M$$

is onto if $i > 3$.

Next one frames the bundle ξ over $C_1 \cup C_2$ of vectors which over C_1 are normal to D^2 and to S^i and which over C_2 are normal to D^2 and tangent to S^{n-i} . The dimension of ξ is $n-i-1$, so ξ can be reframed by any element of $\pi_1 O(n-i-1)$, i.e., stably by an arbitrary $b \in \pi_1 O \approx \mathbb{Z}_2$ if $n-i-1 \geq 2$.

If $n-i=2$ we must resort to more drastic means for realizing the \mathbb{Z}_2 factor. The disc D^2 depends on choosing a direction to push $C_1 \cup C_2$ off $S^i \cup S^{n-i}$. This choice can be altered by rechoosing the section of $\nu(S^i, V^n)|_{C_1}$ determined by the inward normal of D^2 along C_1 , a choice classified by an element of $\pi_1 S^{n-i-1} \approx \pi_1 O(n-i) \approx \mathbb{Z}$ whose image in $\pi_1 O$ is the prescribed $b \in \mathbb{Z}_2$.



Finally, the framing of ξ is extended to a field of $(n-i-1)$ -frames in $\nu(D^2, V^n)$. The obstruction to doing this lies in $\pi_1 V_{n-i-1, n-2} \approx \pi_1(O(n-2)/O(i-1))$ which is zero if $i \geq 3$.

Now the $i+1/i$ intersection points p_σ and $p_{-\sigma}$ can be cancelled in two ways, according to the choices of D^2 and the choices of framing of ξ differing by $a \in \pi_2 M$ and $b \in \pi_1 O \approx \mathbb{Z}_2$. Then the critical points can be cancelled in two ways, producing a one-parameter family f_t with graphic  and with one S^1 component of $i+1/i$ intersections. It is not hard to see that the invariant of this S^1 is $(b, a)\sigma \in (\mathbb{Z}_2 \times \pi_2 M)[\pi_1 M]$.

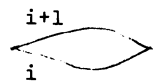
By iteration of this procedure one can construct several components of $i+1/i$ intersections with arbitrary invariant in $(\mathbb{Z}_2 \times \pi_2 M)[\pi_1 M]$.

Remarks. When $i = n - 2$ (and dually when $i = 2$) the $(\mathbb{Z}_2 \times \pi_2)[\pi_1]$ invariant associated to a graphic  can be destabilized to a $(\mathbb{Z} \times \pi_2)[\pi_1]$ invariant. In effect, each S^1 component of $i+1/i$ intersections is framed in $S^{n-i} \times I$, and the bordism classes of such framed one-manifolds in $S^2 \times I$ are classified by $\mathbb{Z} \approx \pi_3 S^2$. The construction in the preceding proposition realizes all elements of $(\mathbb{Z} \times \pi_2)[\pi_1]$ as $i+1/i$ invariants if $n \geq 5$.

There is another unstable invariant when $i = n - 2$ (or $i = 2$) which measures the linking of components of $i+1/i$ intersection $S_j^1 \subset S^{n-i} \times I$ having different π_1 invariants σ_j . This obstruction lies in the group $\mathcal{L}[\pi_1]$ of skew-symmetric functions $\pi_1 \times \pi_1 \rightarrow \mathbb{Z}$ which are zero almost everywhere. Geometrically $\mathcal{L}[\pi_1]$ can be described as the group of closed oriented one-manifolds $T = \bigcup_{\sigma \in \pi_1} T_\sigma$ embedded in S^3 , with T equivalent to $T' = \bigcup_{\sigma \in \pi_1} T'_\sigma$ if there is a compact oriented surface $S = \bigcup_{\sigma \in \pi_1} S_\sigma$ embedded in $S^3 \times I$ such that $\partial S_\sigma = T_\sigma \cup (-T'_\sigma)$, $S_\sigma \cap S^3 \times \{0\} = T_\sigma$, and $S_\sigma \cap S^3 \times \{1\} = T'_\sigma$ for all $\sigma \in \pi_1$. Again all elements of $\mathcal{L}[\pi_1]$ are realized as $i+1/i$ invariants whenever $n \geq 5$.

One is forced to consider these unstable obstructions when $n = \dim M = 5$. For by Chapter VI a one-parameter family with vanishing $Wh_2 \pi_1 M$ invariant can have its graphic reduced to either  or , both of which lie in the unstable range if $n = 5$. The question then is, how much of this local $(\mathbb{Z} \times \pi_2)[\pi_1] \oplus \mathcal{L}[\pi_1]$ invariant survives to $\pi_0 \mathcal{P}(M)$?

Another problem is to decide whether the stable obstruction suffices in Lemma 3 when $n = 6$ and $i = n - i = 3$.

Note added in proof (May, 1973, upon seeing Volodin's announcement in Uspeki 1972 #5)

It is very easy to extend Proposition 1 of this chapter, and hence the main theorem of the paper, to the case $n = 6$. The only place where $n \geq 7$ was used was on p. VII.6 for the injectivity of

$$\pi_2(V^n - (S^i \cup S^{n-i})) \rightarrow \pi_2(V^n - S^{n-i}).$$

In fact $3 \leq i \leq n-3$ is sufficient for this. For by a sequence of "Whitney cancellations" (which take place each in a neighborhood of a two-disc and hence have no effect on π_2 provided $n \geq 6$) the intersection of S^i and S^{n-i} can be made one point transverse. And in this standard position the injectivity is clear.

CHAPTER VIII. Product and Duality Formulae.

In this chapter we give product and duality formulae for the Wh_2 obstruction which are in every way analogous to the corresponding formulae for the torsion of an h-cobordism.

Let N be a closed manifold. Then a natural map $\mathcal{C}(M, \partial M) \rightarrow \mathcal{C}(M \times N, \partial M \times N)$ is obtained by sending a pseudo-isotopy $F: M \times I \rightarrow M \times I$ to $F \times id_N: M \times N \times I \rightarrow M \times N \times I$. Denote the standard inclusion $M \subset M \times N$ by i ; this induces a homomorphism i_* on $Wh_2\pi_1$.

Product Formula $\Sigma([F \times id_N]) = \chi(N)i_*\Sigma([F])$, where $\chi(N)$ is the Euler characteristic of N .

Proof. Let $f_t: M \times (I, 0, 1) \rightarrow (I, 0, 1)$ be a nice one-parameter family suitable for computing $\Sigma([F])$ and let $g: N \rightarrow \left[\frac{1}{4}, \frac{3}{4}\right]$ be a morse function. Define $h_t: M \times N \times (I, 0, 1) \rightarrow (I, 0, 1)$ by

$$h_t = \left(1 - \frac{\varphi(t) \circ (f_t)}{2}\right) f_t + \frac{\varphi(t) \circ (f_t)}{2} g$$

where $\varphi: I \rightarrow I$ is given by its graph:

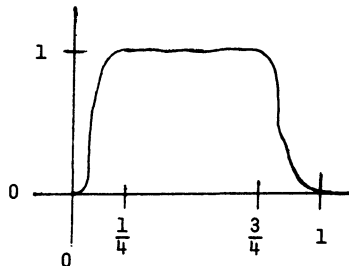

Since $h_0 = f_0$ and $h_1 = f_1$, h_t represents $[F \times \text{id}_N]$ under the natural isomorphism $\pi_0(\mathcal{P}) \approx \pi_1(\mathcal{F}, \mathcal{E})$.

Claim: $(x, y, s) \in M \times N \times I$ is a critical point of h_t only if $(x, s) \in M \times I$ is a critical point of f_t .

For consider a directional derivative in the $M \times I$ factor:

$$h'_t = \left(1 - \frac{\varphi(t)\varphi'(f_t)}{2}\right) f'_t + (g - f_t) \frac{\varphi(t)\varphi'(f_t)}{2} f'_t$$

If $f'_t \neq 0$ and $h'_t = 0$ then

$$1 - \frac{\varphi(t)\varphi'(f_t)}{2} = \frac{\varphi(t)\varphi'(f_t)}{2} (f_t - g)$$

which is impossible since the left side of this equation is $\geq \frac{1}{2}$ while the right side is ≤ 0 . Thus the claim is established.

If we suppose, as we may, that f_t has critical points only if $\frac{1}{4} \leq t \leq \frac{3}{4}$ and that all critical values of f_t lie in the interval $\left[\frac{1}{4}, \frac{3}{4}\right]$, then h_t also has critical points only in $h_t^{-1}\left[\frac{1}{4}, \frac{3}{4}\right]$, $\frac{1}{4} \leq t \leq \frac{3}{4}$, where in fact $h_t = \frac{1}{2}(f_t + g)$.

Next assume:

(i) The critical values $g(p_1) < g(p_2) < \dots < g(p_m)$ of g are all distinct.

(ii) All critical values of f_t lie in $\left(\frac{1}{2}, \frac{1}{2} + \varepsilon\right)$ where $\varepsilon < \min_j \{g(p_j) - g(p_{j-1})\}$.

These assumptions guarantee that the critical points of h_t are separated into m disjoint layers by non-critical levels $h_t^{-1}(\frac{1}{4} + \frac{1}{2}g(p_j))$.

The restriction h_t^j of h_t to the j^{th} layer has {critical points of h_t^j } = {critical points of f_t } \times $\{p_j\}$. Moreover h_t^j is a nice-one parameter family. The product of nice gradient-like vector fields for f_t and g is a nice gradient-like vector field for h_t^j which has the same intersections of stable and unstable manifolds as the vector field for f_t had. In particular,

$$\Sigma([h_t^j]) = (-1)^{\text{Index}(p_j)} i_* \Sigma([f_t]).$$

The m -fold vertical adjunction of the nice one-parameter families h_t^j can easily be deformed to a horizontal adjunction, preserving intersections of stable and unstable manifolds within each layer. For example,

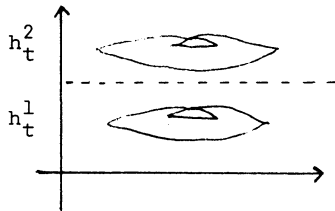

can be deformed to

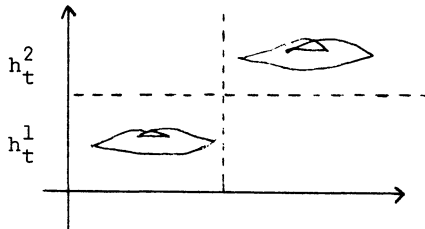

$$\begin{aligned} \text{Then } \Sigma([h_t]) &= \sum_{j=1}^m \Sigma([h_t^j]) = \sum_{j=1}^m (-1)^{\text{Index}(p_j)} i_{\star} \Sigma([f_t]) \\ &= \chi(N) i_{\star} \Sigma([f_t]). \end{aligned}$$

We turn now to the duality formula. If $F \in \mathcal{C}(M, \partial M)$, define $\bar{F} \in \mathcal{C}(M, \partial M)$ by $\bar{F} = F_1^{-1} \circ \psi \circ F \circ \psi$, where $F_1: M \times I \rightarrow M \times I$ is the constant isotopy $F|_{M \times \{1\}}$, i.e., $F_1(x, s) = (F(x, 1), s)$, and $\psi(x, s) = (x, 1-s)$ for $(x, s) \in M \times I$. We seek a formula for $\Sigma([\bar{F}])$ in terms of $\Sigma([F])$.

Let $\lambda \mapsto \bar{\lambda}$ be the anti-automorphism of $\mathbb{Z}[\pi_1 M]$ induced from $g \mapsto w(g)g^{-1}$, where $g \in \pi_1 M$ and $w: \pi_1 M \rightarrow \{\pm 1\}$ is the orientation class. If $(a_{jk}) \in \text{GL}(\mathbb{Z}[\pi_1 M])$, let $\overline{(a_{jk})} = (\bar{a}_{kj})$. On $E(\mathbb{Z}[\pi_1 M])$ this "conjugation" is given by $e_{jk}^\lambda \mapsto e_{kj}^{\bar{\lambda}}$. The correspondence $x_{jk}^\lambda \mapsto x_{kj}^{\bar{\lambda}}$ is easily seen to preserve the Steinberg relations between the generators x_{jk}^λ for the Steinberg group $\text{St}(\mathbb{Z}[\pi_1 M])$ and so induces an anti-automorphism of $\text{St}(\mathbb{Z}[\pi_1 M])$. This in turn gives automorphisms of $K_2 \mathbb{Z}[\pi_1 M]$ and $\text{Wh}_2(\pi_1 M)$ since $\overline{w_{jk}(\pm g)} = w_{kj}(\pm \bar{g})$, $g \in \pi_1 M$. The latter involution will be written $\Sigma \rightarrow \bar{\Sigma}$.

Duality Formula $\Sigma([\bar{F}]) = (-1)^{n \bar{\Sigma}}([F])$, where $n = \dim M$.

Proof. We first observe that if $f_t: M \times I \rightarrow I$ is a nice one-parameter family from which $\Sigma([F])$ is computed, then the family $1 - f_t$ is suitable for computing $\Sigma([\bar{F}])$.

PRODUCT AND DUALITY FORMULAE

For simplicity we shall use the definition $\Sigma([f_t]) = (-1)^{i+1} \Sigma_{i+1}([f_t])$ of V §6, where f_t is assumed to have all its critical points of index i and $i+1$ (and hence $1-f_t$ has critical points of index $n-i$ and $n-i+1$). If M_1, M_2, \dots, M_m is the sequence of algebraic $i+1/i$ intersection matrices in $E(\mathbb{Z}[\pi_1 M])$ which is used to define $\Sigma_{i+1}([f_t])$ as in V §6, so that M_{j+1} is obtained from M_j by multiplying by some elementary matrix corresponding to passing an $i+1/i+1$ or i/i intersection, then the corresponding sequence for $\Sigma_{n-i+1}([1-f_t])$ is $\bar{M}_1, \bar{M}_2, \dots, \bar{M}_m$. Thus $\Sigma_{n-i+1}([1-f_t]) = \bar{\Sigma}_{i+1}([f_t])$ and

$$\begin{aligned} \Sigma([1-f_t]) &= (-1)^{n-i+1} \Sigma_{n-i+1}([1-f_t]) \\ &= (-1)^n (-1)^{i+1} \bar{\Sigma}_{i+1}([f_t]) \\ &= (-1)^n \Sigma([f_t]) . \end{aligned}$$

References

- [1] H. Bass, Algebraic K-Theory, Benjamin, 1968.
- [2] J. M. Boardman, Singularities of differentiable mappings, Publ. Math., I.H.E.S. 33(1967), 21-57.
- [3] J. Cerf, La stratification naturelle des espaces de fonctions différentiables réelles et le théorème de la pseudo-isotopie, Publ. Math. I.H.E.S. 39(1970).
- [4] J. Cerf, Topologie de certains espaces de plongements, Bull. Soc. Math. France, 89(1961), p. 227-380.
- [5] A. Chenciner, Thèse à Orsay 1970: Sur la géométrie des strates de petites codimensions de l'espace des fonctions différentiables réelles sur une variété.
- [6] A. Chenciner, F. Laudenbach, Théorie de Smale à un paramètre dans le cas non simplement connexe, Ann. Sci. Ecole Norm. Sup., 1970, 409-478.
- [7] Keith Dennis, K_2 and the stable range condition, (to appear).
- [8] H. Garland, Finiteness for K_2 of a number field, (to appear).
- [9] S. Gerstein, K-theory of a polynomial extension, (to appear).
- [10] D. Gromoll and W. Meyer, On differentiable functions with isolated critical points, Topology Vol. 8(1969), pp. 361-369.
- [11] A. Hatcher, A K_2 obstruction for pseudo-isotopies, Thesis, Stanford University, 1971.
- [12] A. Hatcher, The Second Obstruction for Pseudo-isotopies, this volume.
- [13] A. Hatcher and F. Quinn, Bordism invariants for intersections of submanifolds, preprint from Princeton University.
- [14] M. Hirsch and C. Pugh, Stable manifolds for hyperbolic sets, A.M.S. Sym. Pure Math. Vol. 14 (Berkeley Conference on Global Analysis).
- [15] J. F. P. Hudson, Concordance and isotopy, B.A.M.S. 72(1966), pp. 534-35.
- [16] M. Kervaire, Le Théorème de Barden-Mazur-Stallings, Comm. Math. Helv. 40(1965), p.31-42.
- [17] J. Milnor, Whitehead Torsion, B.A.M.S. Vol. 72(1966).

- [18] J. Milnor, Lectures on the h-cobordism theorem, Princeton Mathematical Notes (1965).
- [19] J. Milnor, Introduction to Algebraic K-theory, Annals Study #72, Princeton University Press.
- [20] C. Morlet, Plongements et automorphismes de variétés, Collège de France; Paris 1969 (multigraphié).
- [21] M. Morse, The calculus of variations in the large, Am. Math. Soc. Coll. Pub. 8(1934).
- [22] L. Siebenmann, Torsion invariants for pseudo-isotopies of closed manifolds, Notices of A.M.S. 14, 1967, 942.
- [23] S. Smale, Stable manifolds for differential equations and diffeomorphisms, Ann. Scuola Norm. Sup. Pisa (3) 17(1963), 97-116.
- [24] J. Stallings, Whitehead Torsion of free products, Annals of Math. 82(1965), pp. 354-363.
- [25] R. G. Swan, Algebraic K-Theory, Springer-Verlag Lecture Notes in Math #76, 1968.
- [26] A. Takens, A solution to a problem of Thom, Manifolds-Amsterdam 1970, Springer-Verlag Math. Lecture Notes #197.
- [27] R. Thom, Topological models in biology, Topology Vol. 8, 313-335.
- [28] J. B. Wagoner, Algebraic invariants for pseudo-isotopies, Proceedings of Liverpool Singularities Symposium II, Springer-Verlag Notes in Math #209.
- [29] J. B. Wagoner, On K_0 of the Laurent polynomial ring, Amer. Jour. Math, January 1971.
- [30] C. T. C. Wall, Geometrical Connectivity I., Jour. London Math. Society (2), 3(1971), 597-604.
- [31] A. Weinstein, Families of C^∞ mappings, to appear.
- [32] Wu-chung Hsiang, Decomposition formulae for Laurent extensions in algebraic K-theory and the role of codimension one submanifolds in topology, to appear in Battelle Algebraic K-theory Proceedings, Springer-Verlag Notes.
- [33] I. A. Volodin, Algebraic K-theory as extraordinary homology theory on the category of associative rings with unity, Math. of the USSR-Izvestija Vol. 5, No. 4, Aug. 1971 (English translation).

- [34] J. Wagoner, Stratifications, buildings, and higher K-theories, to appear in Battelle Algebraic K-Theory Proceedings, Springer-Verlag lecture notes.
- [35] I. A. Volodin, Algebraic K-Theory, Uspeki Math. Nauk 1972, #4. See #5 also.
- [36] A. Hatcher, On the two parameter h-cobordism Theorem for two-connected manifolds, preprint from Princeton University.

PART II

THE SECOND OBSTRUCTION FOR PSEUDO-ISOTOPIES

Allen E. Hatcher^{*}

^{*}Supported in part by NSF grant GP-34324X.

0§. Introduction.

In this paper we complete the computation, begun in [H-W], of obstructions for pseudo-isotopies on a non-simply connected smooth compact manifold M of sufficiently large dimension. More precisely, we define and compute an algebraic K-theory functor

$Wh_1(\pi_1 M; \mathbb{Z}_2 \times \pi_2 M)$, and we define a homomorphism

$\theta: \pi_0 \mathcal{P}(M, \partial M) \longrightarrow Wh_1(\pi_1 M; \mathbb{Z}_2 \times \pi_2 M)$, where $\mathcal{P}(M, \partial M)$ is the group of diffeomorphisms of $M \times I$ which restrict to the identity on $M \times \{0\} \cup \partial M \times I$. Combined with results of [H-W], θ gives a homomorphism $\Sigma + \theta: \pi_0 \mathcal{P}(M, \partial M) \longrightarrow Wh_2 \pi_1 M \oplus Wh_1(\pi_1 M; \mathbb{Z}_2 \times \pi_2 M)$ which is surjective if $\dim M \geq 5$ and injective if $\dim M \geq 7$.

The computation of $Wh_1(\pi_1 M; \mathbb{Z}_2 \times \pi_2 M)$ has two striking corollaries: First, that $\pi_0 \mathcal{P}(M, \partial M)$ depends not only on $\pi_1 M$ but also on $\pi_2 M$ and the action of $\pi_1 M$ on $\pi_2 M$. And second, that $\pi_0 \mathcal{P}(M, \partial M) = 0$ if and only if $\pi_1 M = 0$ (provided $\dim M \geq 5$).

§1. Algebraic Preliminaries

Let Γ be an abelian group acted on by a group π , and let $\Gamma[\pi]$ be the additive group consisting of finite formal sums

$\sum_i \alpha_i \sigma_i$, $\alpha_i \in \Gamma$, $\sigma_i \in \pi$, with $\sum_i \alpha_i \sigma_i + \sum_i \alpha'_i \sigma_i = \sum_i (\alpha_i + \alpha'_i) \sigma_i$. We make the

product $\Gamma[\pi] \times \mathbb{Z}[\pi]$ into a ring by the multiplication

$$\sum_i (\alpha_i + m_i) \sigma_i \cdot \sum_j (\beta_j + n_j) \tau_j = \sum_{ij} (m_i \beta_j^{\sigma_i} + n_j \alpha_i + m_i n_j) \sigma_i \tau_j \quad \text{where}$$

$\alpha_i, \beta_j \in \Gamma, \sigma_i, \tau_j \in \pi, m_i, n_j \in \mathbb{Z}$, and β^σ denotes the action of σ on β .

In particular, $\Gamma[\pi]$ is given trivial multiplication, and there is a split exact sequence

$$(*) \quad 0 \longrightarrow \Gamma[\pi] \longrightarrow \Gamma[\pi] \times \mathbb{Z}[\pi] \longrightarrow \mathbb{Z}[\pi] \longrightarrow 0.$$

The example we have in mind is $\Gamma = \mathbb{Z}_2 \times \pi_2 M$, $\pi = \pi_1 M$, with the usual action of π_1 on π_2 and the trivial action on \mathbb{Z}_2 . The sequence (*) in this case can be identified naturally with the sequence

$$0 \longrightarrow \Omega_1^{\text{fr}}(\Omega M) \longrightarrow \Omega_1^{\text{fr}}(\Omega M) \times \Omega_0^{\text{fr}}(\Omega M) \longrightarrow \Omega_0^{\text{fr}}(\Omega M) \longrightarrow 0.$$

Under this identification the multiplication described above corresponds to the (graded) multiplication on $\Omega_*^{\text{fr}}(\Omega M)$ induced by the natural H-space structure of the loop space ΩM . See [H-Q], §3.

Recall the definition of K_1 of an ideal \mathcal{A} in a ring \mathcal{R} , according to [B] or [M]. Let

$$\begin{aligned} \text{GL}(\mathcal{A}) &= \ker (\text{GL}(\mathcal{R}) \longrightarrow \text{GL}(\mathcal{R}/\mathcal{A})) \\ &= \{I + A \in \text{GL}(\mathcal{R}) \mid A \text{ has entries in } \mathcal{A}\} \end{aligned}$$

and let $E(\mathcal{A})$ be the mixed commutator subgroup $[\text{GL}(\mathcal{R}), \text{GL}(\mathcal{A})]$, which is also the subgroup of $\text{GL}(\mathcal{A})$ generated by matrices STS^{-1} for T an elementary matrix in $\text{GL}(\mathcal{A})$ and $S \in E(\mathcal{R})$. Then $K_1 \mathcal{A}$, which is sometimes written $K_1(\mathcal{R}, \mathcal{A})$, is defined as

$GL(\mathcal{A})/E(\mathcal{A})$.

Proposition 1.1. If $\mathcal{A}^2 = 0$ then $K_1 \mathcal{A} \cong \mathcal{A}_{(ar-ra)}$ via $[I + A] \longrightarrow \text{tr}(A)$, where $(ar-ra)$ denotes the additive subgroup of \mathcal{A} generated by $\{ar-ra \mid a \in \mathcal{A}, r \in \mathcal{R}\}$.

Proof. If $A = (a_{jm})$ is a finite matrix over \mathcal{A} then $\text{tr}(A)$, which is defined as $\sum a_{ii}$ reduced modulo $(ar-ra)$, satisfies $\text{tr}(A + B) = \text{tr}(A) + \text{tr}(B)$ and $\text{tr}(RA) = \text{tr}(AR)$ where B is also a finite matrix over \mathcal{A} and R is a matrix over \mathcal{R} .

Define $\varphi: GL(\mathcal{A}) \longrightarrow \mathcal{A}_{(ar-ra)}$ by $\varphi(I + A) = \text{tr}(A)$. Since $(I + A)(I + B) = I + A + B$, φ is a homomorphism. Also, φ vanishes on $E(\mathcal{A})$. For let $S \in E(\mathcal{R})$ and let $T \in GL(\mathcal{A})$ be an elementary matrix. Then $\varphi(STS^{-1}) = \text{tr}(STS^{-1} - I) = \text{tr}(S(T - I)S^{-1}) = \text{tr}(T - I) = 0$.

So φ induces $\bar{\varphi}: K_1 \mathcal{A} \longrightarrow \mathcal{A}_{(ar-ra)}$.

We show $\bar{\varphi}$ is injective. First a computation: For $a \in \mathcal{A}$ and $r \in \mathcal{R}$, the product $e_{jk}^r e_{kj}^a e_{jk}^{-r}$ in $E(\mathcal{A})$ is given by

$$\begin{matrix} & j & k \\ j & \begin{pmatrix} 1 + ra & -rar \\ a & 1 - ar \end{pmatrix} \\ k & \end{matrix}$$

with all other entries the same as in the identity matrix. Now if $A = (a_{jm})$ has $\text{tr}(A) = 0$, then by multiplying $I + A$ by suitable $e_{jk}^r e_{kj}^a e_{jk}^{-r}$ we can make $\sum a_{ii} = 0$. Next, multiply $I + A$ by

suitable $e_{jk}^1 e_{kj}^a e_{jk}^{-1}$ to make each diagonal entry of A zero.

Finally, the off-diagonal entries of A can be killed by multiplying $I + A$ by suitable e_{jk}^a . Thus $I + A \in E(\mathcal{A})$ if $\text{tr}(A) = 0$.

For any finite matrix A over \mathcal{A} , $(I + A)^{-1} = I - A$, so $I + A \in GL(\mathcal{A})$. Hence $\bar{\varphi}: K_1 \mathcal{A} \longrightarrow \mathcal{A}/(\text{ar-ra})$ is surjective, and the proposition is proved.

Choosing $\mathcal{A} = \Gamma[\pi]$ and $\mathcal{R} = \Gamma[\pi] \times \mathbb{Z}[\pi]$, we have:

Corollary 1.2. $K_1 \Gamma[\pi] \approx \Gamma[\pi]/(\alpha \sigma - \alpha^\tau \tau \sigma \tau^{-1})$, where $\alpha \in \Gamma$ and $\sigma, \tau \in \pi$.

Remark. This computation shows that excision fails for $K_1 \Gamma[\pi]$. That is, $K_1 \Gamma[\pi]$ depends not just on the intrinsic structure of $\Gamma[\pi]$, but also on the ring $\Gamma[\pi] \times \mathbb{Z}[\pi]$, since $\Gamma[\pi]$ ignores the multiplication in π and the action of π on Γ . See [S] for more general examples of this phenomenon.

If 1 denotes the identity of π , let $\Gamma[1] \longrightarrow K_1 \Gamma[\pi]$ be the map taking $\beta \cdot 1$ to the class of $I + (\beta \cdot 1)$, where $(\beta \cdot 1)$ is the 1×1 matrix with entry $\beta \cdot 1$, $\beta \in \Gamma$.

Definition. $Wh_1(\pi; \Gamma) = \text{coker}(\Gamma[1] \longrightarrow K_1 \Gamma[\pi])$

Corollary 1.3. $Wh_1(\pi; \Gamma) \approx \Gamma[\pi]/(\alpha \sigma - \alpha^\tau \tau \sigma \tau^{-1}, \beta \cdot 1)$, where $\alpha, \beta \in \Gamma$ and $\sigma, \tau \in \pi$.

For example, if the action of π on Γ is trivial then $Wh_1(\pi; \Gamma)$ is the direct sum of as many copies of Γ as there are

non-trivial (i.e., other than $\{1\}$) conjugacy classes in π . This applies to the summand $Wh_1(\pi_1 M; \mathbb{Z}_2)$ of $Wh_1(\pi_1 M; \mathbb{Z}_2 \times \pi_2 M)$ to show that $Wh_1(\pi_1 M; \mathbb{Z}_2 \times \pi_2 M) = 0$ if and only if $\pi_1 M = 0$.

§2. Definition of the $Wh_1(\pi_1; \mathbb{Z}_2 \times \pi_2)$ Obstruction

Let $f_t: M^n \times I \longrightarrow I$ be a nice one-parameter family having all nondegenerate critical points of index i and $i + 1$, with f_0 and f_1 having no critical points. By Theorem V. 3.1 of [H-W] any element of $\pi_1(\mathcal{F}, \mathcal{E})$ is represented by such a family if $2 \leq i \leq n - 2$. A gradient-like vector field in general position is given for f_t , with birth-death points independent (See I §6 of [H-W]). Away from the isolated $i + 1/i + 1$ and i/i intersections the $i + 1/i$ intersections form a one-dimensional submanifold (of a suitable level surface) with one boundary point at each birth-death point. The way $i + 1/i$ intersections fit together at $i + 1/i + 1$ or i/i intersections is more complicated and will be described in some detail below, as it is the key piece of geometry which allows all the algebra to work.

To define the $Wh_1(\pi_1; \mathbb{Z}_2 \times \pi_2)$ invariant of f_t we begin by subdividing the t interval $[0, 1]$ into a finite number of sub-intervals, with subdivisions occurring at least at t slices containing $i + 1/i + 1$ or i/i intersections or birth-death points,

and perhaps at other t slices too. Then by a suitable normalization procedure at the subdivision slices we will assign an element of $(\mathbb{Z}_2 \times \pi_2 M) [\pi_1 M]$ to each component of $i + 1/i$ intersection lying within a t interval. This will determine in the j^{th} t interval a matrix A_j over $(\mathbb{Z}_2 \times \pi_2) [\pi_1]$ of "geometric" $i + 1/i$ intersection numbers for the various $i + 1$ and i -handles. The $Wh_1(\pi_1; \mathbb{Z}_2 \times \pi_2)$ invariant of f_t will be defined to be represented by the matrix $I + \sum M_j^{-1} A_j$, where $M_j \in GL(\mathbb{Z} [\pi_1])$ is the usual matrix of "algebraic" $i + 1/i$ intersection numbers for a t slice in the j^{th} t interval.

Notation: A k -handle a will be written as $D_a^k \times D_a^{n+1-k}$, with D_a^k the core disc, $\partial D_a^k = S_a^{k-1}$ the core sphere, D_a^{n+1-k} the transverse disc, and $\partial D_a^{n+1-k} = S_a^{n-k}$ the transverse sphere.

The matrices M_j depend on several choices:

- i) a basepoint $*$ $\in M \times I \times I$, together with an orientation of $M \times I \times I$ at $*$.
- ii) a path $\gamma(a)$ from $*$ to each arc a of $i + 1$ -handles, together with an orientation of the core disc D_a^{i+1} . (The orientation at $*$ transposed along $\gamma(a)$ then determines an orientation of the transverse disc D_a^{n-i} .)
- iii) an ordering of all the arcs of $i + 1$ -handles.

By insisting that at a birth point the two handles of an $i + 1/i$ handle pair have algebraic intersection number $+1$, the choices in ii) for $i + 1$ -handles determine analogous choices for i -handles. Likewise, the ordering of $i + 1$ -handles in iii) transfers via birth points to an ordering of the i -handles.

Having made these choices, each $i + 1/i + 1$ or i/i intersection determines an elementary matrix $e_{\ell m}^{\sigma}$, with $\sigma \in \pm \pi_1 M$, so that in passing an $i + 1/i + 1$ (i/i) intersection the algebraic $i + 1/i$ intersection matrix changes by right (resp. left) multiplication by $e_{\ell m}^{\sigma}$ (resp. $e_{\ell m}^{-\sigma}$). Thus $M_j = G_j^{-1} F_j$ where F_j (G_j) is the product of elementary matrices corresponding to $i + 1/i + 1$ (resp. i/i) intersections prior to the j^{th} t interval.

To define the matrices A_j we shall exploit the following construction. Let x be a point of $i + 1/i$ intersection, i.e., a trajectory of the gradient-like vector field connecting an $i + 1$ -handle a with an i -handle b . Then $\lambda(x)$ is defined to be the loop proceeding from $*$ $\in M \times I \times I$ to a along $\gamma(a)$, from a to b along the trajectory x , and from b to $*$ along $\gamma(b)$. A similar definition holds if x is an $i + 1/i + 1$ or i/i intersection point.

Each component C of $i + 1/i$ intersection determines an element $\sigma(C) \in \pi_1 M$, the class of the loop $\gamma(x)$ for $x \in C$. Up to

sign this is just the usual algebraic intersection number associated to any $x \in C$.

Now choose the following:

iv) a) A loop $g(\sigma)$ in $M \times I \times I$ representing each $\sigma \in \pi_1(M \times I \times I, *) \approx \pi_1 M$ and b) for $\sigma, \tau \in \pi_1 M$ a homotopy from $g(\tau \sigma)$ to $g(\tau)g(\sigma)$. (Composition of loops reads from right to left, just as for matrices.)

Define $\tilde{\lambda}(x)$ to be $g^{-1}(x)\lambda(x)$, the loop $\lambda(x)$ followed by $g^{-1}(x)$, where " $g^{-1}(x)$ " means " $g^{-1}([\lambda(x)])$." Thus $\tilde{\lambda}(x)$ is contractible.

Figure 1.

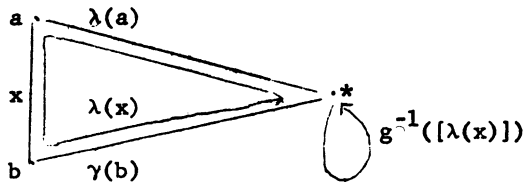

If a component C of $i + 1/i$ intersection lying within a t interval is a circle, then $\tilde{\lambda}$ gives a map $\tilde{\lambda}(C): S^1 \rightarrow \Omega M_0$, where ΩM_0 is the identity component of the loop space $\Omega M \simeq \Omega(M \times I \times I, *)$. The identification of C with S^1 here depends on a choice of orientation of C , say by the convention that at a point of transverse $i + 1/i$ intersection with algebraic intersection number $+\sigma(C)$, C is oriented in the $+t$ direction.

Furthermore, the stable normal bundle of C is framed, as follows: C is a component of $S_a^1 \times I \cap S_b^{n-1} \times I \subset V \times I$, V an intermediate level surface. The orientations chosen above give a framing of

$$v(D_a^{i+1} \times I, M \times I \times I)|_{S_a^1 \times I} \approx v(S_a^1 \times I, V \times I) \approx v(C, S_b^{n-1} \times I).$$

Stabilizing by adding the direction of the trajectories through C , i.e., the radial direction in D_b^{n+1-i} , we get a framing of $v(C, D_b^{n+1-i} \times I)$.

Thus C determines an element $\alpha(C) \in \Omega_1^{fr}(\Omega M_0)$, the framed bordism group.

Remarks 1) Under the natural isomorphism

$$\Omega_1^{fr}(\Omega M_0) \approx \Omega_1^{fr}(\ast) \times \tilde{\Omega}_1^{fr}(\Omega M_0) \approx \mathbb{Z}_2 \times \pi_2 M, \alpha(C) \text{ corresponds to the } \mathbb{Z}_2 \times \pi_2 M \text{ obstruction for } C \text{ defined in VII of [H-W].}$$

This is clear for the \mathbb{Z}_2 component. The $\pi_2 M$ component as defined in [H-W] is given by $S^2 \subset M \times I \times I$, the closure of the trajectories through points of C , joined to \ast by the path $\gamma(a)$ from the $i+1$ -handle a to \ast . To compare this with the map $S^1 \times S^1 \longrightarrow M \times I \times I$ given by $\tilde{\lambda}(C): S^1 \longrightarrow \Omega M_0$, we identify $\pi_2 M$ with $H_2 \tilde{M}$, where \tilde{M} is the universal cover of M . Then the difference between the elements of $H_2 \tilde{M}$ determined by S^2 and $S^1 \times S^1$ is just the paths $\gamma(b)$ and the loops $g^{-1}(\sigma(C))$, each of which is counted once for each $x \in C$. Clearly these contribute

zero to the element of $H_2\tilde{M}$.

2) Under the isomorphism $\Omega_1^{fr}(\Omega M) \approx \Omega_1^{fr}(\Omega M_0)[\pi_1 M]$ the element of $\Omega_1^{fr}(\Omega M)$ determined by $\lambda(C):S^1 \rightarrow \Omega M$ corresponds to $\alpha(C)\sigma(C)$.

Before extending the definition of $\alpha(C)$ to the case that C is an arc of $i + 1/i$ intersection we must describe the way $i + 1/i$ intersections fit together near an $i + 1/i + 1$ or i/i intersection. Let a and a' be $i + 1$ -handles near a t slice $t = t_0$ containing an $i + 1/i + 1$ intersection of a over a' , and let b be an i -handle. In a level surface below a' one has the core spheres $S_a^i \times t$ and, for $t \neq t_0$, $S_a^i \times t$. The $i + 1/i + 1$ intersection at t_0 causes $S_a^i \times t_0$ to split open with the local structure of $(\text{cone on 3 points}) \times S^i$, i.e., the stable manifolds of a and a' intersect a level surface below a' as in the diagram

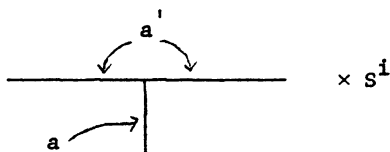

For example when $i = 0$:

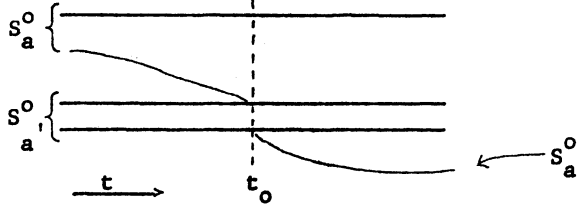

Assuming the $i + 1/i$ intersections of a' and b are in general position near t_0 , and hence form arcs transverse to t slices, then in a level surface below a' the intersection of the stable manifolds of a and a' with the unstable manifold of b has the local structure of a cone on 3 points:

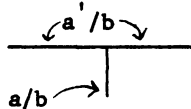

at each arc of a'/b intersection. In general position the arc of a/b intersection abutting the a'/b arc may be taken to be transverse to t -slices.

This describes the $i + 1/i$ intersections in a level between a' and b . In a level between a and a' the picture is slightly different. Here in each t slice the unstable manifold of b meets the unstable manifold of a' with the local structure of (cone on a finite set) $\times S^{n-i-1} \times t$. The vertex of the "cone" is the transverse sphere S_a^{n-i-1} , and there is one "sheet" coming into this vertex for each point of a'/b intersection. These unstable manifolds (cone) $\times S^{n-i-1} \times I$ intersect $S_a^i \times I$ in a one-complex which is just a cone on the same finite set of a'/b intersection points. The vertex of this cone is the $i + 1/i + 1$ intersection point. The arcs of a/b intersection emanating from this vertex will be

transverse to t slices in general position.

All of this is illustrated in the following diagram where there are three points of a'/b intersection in each t -slice:

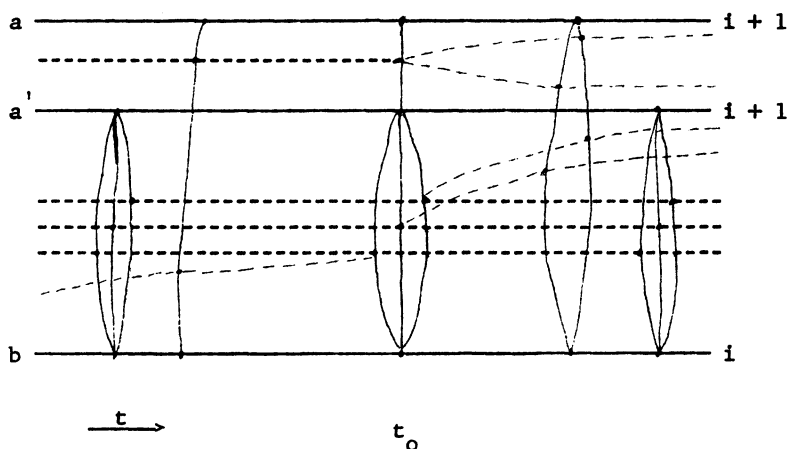

Here the solid horizontal lines are the critical points a , a' , and b , the horizontal dashed lines are the $i+1/i$ intersections in a level surface, and the vertical lines represent selected trajectories of the gradient-like vector field. Note that in t slices approaching t_0 a trajectory from b to a approaches a broken trajectory from b to a' and a' to a .

The case of an i/i intersection is dual.

Now choose

v) a contraction of each loop $\tilde{\lambda}(x)$, for x an $i+1/i+1$

intersection lying in one of the subdividing t slices.

This is meant to include the case of the " $i + 1/i$ intersection" of a birth-death handle pair, where the trajectory joining the two critical points shrinks to zero.

The contractions chosen in v) allow us to define $\tilde{\lambda}(C):S^1 \longrightarrow \Omega M_0$ when C is an arc of $i + 1/i$ intersection, by deforming $\tilde{\lambda}$ at the ends of the arc to $* \in \Omega M_0$. This is clear except perhaps at an end of C which lies at an $i + 1/i + 1$ or i/i intersection. Referring to figure 2, let x denote the trajectory from a to a' , y a trajectory from a' to b , and yx a nearby trajectory from a to b . We seek a contraction of $\tilde{\lambda}(yx) = g^{-1}(yx)\lambda(yx)$. Choice v) gives contractions of $g^{-1}(x)\lambda(x)$ and $g^{-1}(y)\lambda(y)$. These determine in a natural way successive contractions of

$$g^{-1}(x)[g^{-1}(y)\lambda(y)]g(x), [g^{-1}(x)g^{-1}(y)\lambda(y)g(x)][g^{-1}(x)\lambda(x)],$$

$$g^{-1}(x)g^{-1}(y)\lambda(y)\lambda(x), g^{-1}(x)g^{-1}(y)\lambda(yx), \text{ and, using iv.b.),}$$

$$g^{-1}(yx)\lambda(yx).$$

To make $\tilde{\lambda}(C):S^1 \longrightarrow \Omega M_0$ a map in framed bordism we must consider the following situation. Let P^p and Q^q be manifolds with singularities of the type encountered in the discussion preceding figure 2, that is, $(\text{cone on a finite set}) \times \Sigma P$ or $\times \Sigma Q$ for submanifolds ΣP and ΣQ of codimension one. Let P and Q be

embedded in a manifold W^{p+q-1} in general position, so that $P \cap Q$ is a one-dimensional complex with vertices $\Sigma(P \cap Q) = (P \cap \Sigma Q) \cup (\Sigma P \cap Q)$. Away from the singularities of P and Q (i.e., ΣP and ΣQ) it makes sense to talk of normal bundles and normal frames, and transversality gives an isomorphism

$$\nu(P \cap Q - \Sigma(P \cap Q), P - \Sigma P) \approx \nu(Q - \Sigma Q, W) |_{P \cap Q - \Sigma(P \cap Q)}.$$

Moreover it is possible to fit these normal bundles or frames together in a consistent way at the vertices $\Sigma(P \cap Q)$: At vertices in $\Sigma P \cap Q$ one can simply take a normal plane (frame) of $\Sigma P \cap Q$ in ΣP , while at vertices in $P \cap \Sigma Q$ one takes a normal plane (frame) of ΣQ in W which is also normal to all the sheets of Q meeting in the given point of ΣQ . (Note that such planes or frames are dense)

A typical situation of this sort is pictured in figure 3.

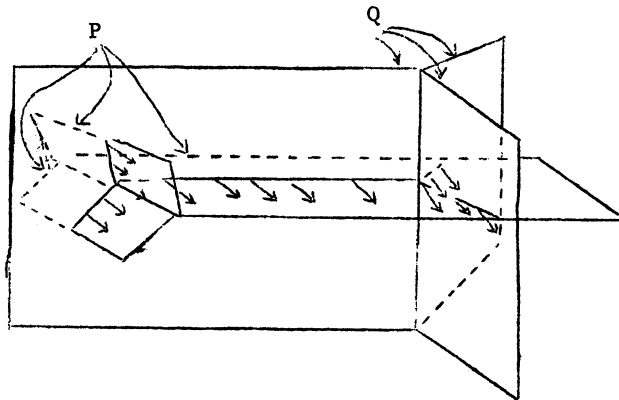

Figure 3

These considerations lead us to make the following choices:

v1) (a) For each point $x \in S_a^i \times t \cap S_b^{n-i} \times t$ of $i + 1/i$ intersection lying in a subdividing t slice, deformations of the framings of $v(S_a^i \times t, V^n \times t)$ and $\tau(S_b^{n-i} \times t)$ so that they agree at x .

(b) For each point $x \in S_a^i \times I \cap S_b^{n-i-1} \times I$ of $i + 1/i + 1$ intersection, deformations of the framings of $v(S_a^i \times I, V^n \times I)$ and $\tau(S_b^{n-i-1} \times I)$ so that they agree at x .

(c) For each point $x \in S_b^{i-1} \times I \cap S_b^{n-i} \times I$ of i/i intersection, deformations of $(n-1)$ -frames in $v(S_b^{i-1} \times I, V \times I)$ and in $\tau(S_b^{n-i} \times I)$ so that they agree at x .

Remarks 1) By "agree" we mean "agree up to sign," i.e., after replacing one vector (say the first) of a frame by its negative if necessary, so that orientations agree.

2) In (a) we mean to include the limiting case of an $i + 1/i$ intersection of a birth-death pair.

3) In each case the choice of deformation is classified by $\mathbb{Z}_2 \approx \pi_1 SO(n-1)$, or $\mathbb{Z}_2 \approx \pi_1 V_{n-1, n-i+1} \approx \pi_1 SO(n-i+1)$ in (c).

Under the J homomorphism this \mathbb{Z}_2 is identified with $\Omega^{fr}(*).$

If C is an arc of $i + 1/i$ intersection of the $i + 1$ -handle a with the i -handle b (in some t interval) we use the choices in v1) to deform the framing of $v(C, S_b^{n-i} \times I)$ induced from the

canonical framing of the normal bundle of the stable manifold of a so that this framing of $\nu(C, S_b^{n-1} \times I)$ agrees with the standard one near the ends of C . Thus comparing the two framings of $\nu(C, S_b^{n-1} \times I)$ along C gives an element of $\pi_1 SO \approx \Omega_1^{fr} (*)$, and this makes $\tilde{\lambda}(C): S^1 \longrightarrow \Omega M_0$ a map in framed bordism, as desired.

Except when an end of C abuts an $i + 1/i + 1$ or i/i intersection, the choice in (a) gives precisely the required deformation. At an $i + 1/i + 1$ or i/i intersection the deformations of framings in (b) or (c) naturally extend to nearby points of $i + 1/i$ intersection. So for example at an $i + 1/i + 1$ intersection the framing of $\nu(S_a^i \times I, V^n \times I)$ at all the $i + 1/i$ intersections abutting the given $i + 1/i$ intersection passes down trajectories past the $i + 1$ -handle a^i , where it now induces a simultaneous framing of $\nu(S_a^i \times I, V^n \times I)$ at each $i + 1/i$ intersection. This is then carried down to i -handles by the choice in (a). Similarly at i/i intersections.

Thus for each component C of $i + 1/i$ intersection in a t interval we have defined $\alpha(C)\sigma(C) \in \Omega_1^{fr}(\Omega M_0)[\pi_1 M]$. Let $a_{k,l}^j = \sum \alpha(C)\sigma(C)$, the sum over all components of $i + 1/i$ intersection of the l^{th} $i + 1$ -handle with the k^{th} i -handle in the j^{th} t interval, and let $A_j = (a_{k,l}^j)$. Recall $M_j \in GL(\mathbb{Z}[\pi_1 M])$ is the algebraic $i + 1/i$ intersection matrix for t slices in the

j^{th} t interval.

Definition. The $\text{Wh}_1(\pi_1 M; \mathbb{Z}_2 \times \pi_2 M)$ invariant of the given one-parameter family is the class of the matrix $I + \sum_j M_j^{-1} A_j$.

Alternatively, we could use $I + \sum_j A_j M_j^{-1}$:

Lemma 2.1. $[I + \sum_j M_j^{-1} A_j] = [I + \sum_j A_j M_j^{-1}]$ in $K_1(\mathbb{Z}_2 \times \pi_2)[\pi_1]$, hence also in $\text{Wh}_1(\pi_1; \mathbb{Z}_2 \times \pi_2)$.

Proof. In K_1 $I + A_j M_j^{-1}$ is equivalent to

$M_j^{-1}(I + A_j M_j^{-1}) M_j = I + M_j^{-1} A_j$, so $I + \sum_j A_j M_j^{-1} = \Pi(I + A_j M_j^{-1})$ is equivalent to $\Pi(I + M_j^{-1} A_j) = I + \sum_j M_j^{-1} A_j$.

§3. Proof that θ is well-defined.

Theorem 3.1. The association $[f_t] \longrightarrow [I + \sum_j M_j^{-1} A_j]$ defined in the preceding section determines a homomorphism

$$\theta: \pi_0 \rho(M, \partial M) \approx \pi_1(\mathcal{F}, \mathcal{E}) \longrightarrow \text{Wh}_1(\pi_1 M; \mathbb{Z}_2 \times \pi_2 M).$$

The proof will consist of showing that the class of $I + \sum_j M_j^{-1} A_j$ in $\text{Wh}_1(\pi_1 M; \mathbb{Z}_2 \times \pi_2 M)$ is independent of the choices which were made in its definition, or at least those choices which depend on $[f_t] \in \pi_1(\mathcal{F}, \mathcal{E})$.

Proposition 3.2. The element $[I + \sum_j M_j^{-1} A_j] \in \text{Wh}_1(\pi_1; \mathbb{Z}_2 \times \pi_2)$ is

independent of the choices made in i)-iii), v), and vi).

Proof. Choices i), ii) and iii) correspond to "change of basis" and affect the M_j and A_j , hence also $I + \sum M_j^{-1} A_j$, by conjugating by an element of $GL(\mathbb{Z}[\pi])$. By the definition of K_1 , such conjugation induces the identity on $K_1(\mathbb{Z}_2 \times \pi_2)[\pi_1]$.

The choices in v) and vi), which we shall refer to as normalizations, are covered in the following three lemmas.

Lemma 3.3. Renormalizing at an $i + 1/i$ intersection other than a birth-death point leaves the matrix $I + \sum M_j^{-1} A_j$ or $I + \sum A_j M_j^{-1}$ fixed.

Proof. Suppose the $i + 1/i$ intersection being renormalized involves the ℓ^{th} i -handle b_ℓ and the m^{th} $i + 1$ -handle a_m , and that the renormalization changes A_k to A'_k and A_{k+1} to A'_{k+1} (i.e., the given $i + 1/i$ intersection separates the k^{th} t interval from the $k+1^{\text{st}}$.)

Notation: $d_{\ell m}^x$ is the matrix with one non-zero entry x in the (ℓ, m) position.

Case 1. The given t -slice contains neither $i + 1/i + 1$ nor i/i intersection. Then $M'_k = M_{k+1}$, $A'_k = A_k + d_{\ell m}^\alpha$, and $A'_{k+1} = A_{k+1} - d_{\ell m}^\alpha$ for some $\alpha \in (\mathbb{Z}_2 \times \pi_2)[\pi_1]$, and the result is immediate.

Case 2. At a t -slice of an $i + 1/i + 1$ intersection of an $i + 1$ -handle a_p over an $i + 1$ -handle a_q . Here

$M_{k+1} = M_k e_{qp}^\sigma$ for some $\sigma \in \pm \pi_1$.

a) $q \neq m$. Then $A'_k = A_k + d_{\ell m}^\alpha$, $A'_{k+1} = A_{k+1} - d_{\ell m}^\alpha$, and

$$(A'_k M_k^{-1} + A'_{k+1} M_{k+1}^{-1}) - (A_k M_k^{-1} + A_{k+1} M_{k+1}^{-1}) = d_{\ell m}^\alpha M_k^{-1} - d_{\ell m}^\alpha M_{k+1}^{-1} =$$

$$d_{\ell m}^\alpha e_{qp}^\sigma M_{k+1}^{-1} - d_{\ell m}^\alpha M_{k+1}^{-1} = 0 \text{ since } d_{\ell m}^\alpha e_{qp}^\sigma = d_{\ell m}^\alpha \text{ if } q \neq m.$$

b) $q = m$ and the arc of a_p/b_ℓ intersection which abuts the a_p/a_m and a_m/b_ℓ intersections lies to the right of the $i + 1/i + 1$ intersection. Then $A'_k = A_k + d_{\ell m}^\alpha$,

$$A'_{k+1} = A_{k+1} - d_{\ell m}^\alpha - d_{\ell p}^{\alpha\sigma} = A_{k+1} - d_{\ell m}^\alpha e_{mp}^\sigma, \text{ so}$$

$$(A'_k M_k^{-1} + A'_{k+1} M_{k+1}^{-1}) - (A_k M_k^{-1} + A_{k+1} M_{k+1}^{-1}) = d_{\ell m}^\alpha M_k^{-1} - d_{\ell m}^\alpha e_{mp}^\sigma M_{k+1}^{-1} = 0$$

since $M_k^{-1} = e_{mp}^\sigma M_{k+1}^{-1}$ if $q = m$.

c) $q = m$ and the arc ... lies to the left of the $i + 1/i + 1$ intersection. Then $A'_k = A_k + d_{\ell m}^\alpha e_{mp}^{-\sigma}$, $A'_{k+1} = A_{k+1} - d_{\ell m}^\alpha$, and

$$A'_k M_k^{-1} + A'_{k+1} M_{k+1}^{-1} = A_k M_k^{-1} + A_{k+1} M_{k+1}^{-1} \text{ as before.}$$

Thus in Case 2 $I + \sum A_j M_j^{-1}$ is preserved.

Case 3. At a t slice of an i/i intersection. This is similar to Case 2; we omit the details.

Lemma 3.4. Renormalizing at a birth-death point changes

$[I + \sum M_j^{-1} A_j] \in K_1(\mathbb{Z}_2 \times \pi_2)[\pi_1]$ by an element of the kernel of $K_1(\mathbb{Z}_2 \times \pi_2)[\pi_1] \longrightarrow \text{Wh}_1(\pi_1; \mathbb{Z}_2 \times \pi_2)$.

Proof. If the t interval to the right (left) of the birth (resp. death) point is the k^{th} t interval, and the birth-death point involves the l^{th} i -handle and m^{th} $i+1$ -handle, then M_k has l^{th} row and m^{th} column consisting entirely of zeros except for some $\sigma \in \pm \pi_1$ in the (l, m) position (birth-death points are assumed independent; [H-W] see I§6). Renormalization changes A_k to $A_k + d_{lm}^{\alpha\sigma}$ for some $\alpha \in \mathbb{Z}_2$ and fixes $A_j, j \neq k$. Since

$$d_{lm}^{\alpha\sigma} M_k^{-1} = d_{lm}^{\alpha\sigma} d_{ml}^{\sigma^{-1}} = d_{ll}^{\alpha \cdot 1}, \quad I + \sum A_j M_j^{-1} \text{ changes to}$$

$$I + \sum A_j M_j^{-1} + d_{ll}^{\alpha \cdot 1} = (I + \sum A_j M_j^{-1})(I + d_{ll}^{\alpha \cdot 1}). \quad \text{But matrices } I + d_{ll}^{\alpha \cdot 1}$$

for $\alpha \in \mathbb{Z}_2 \times \pi_2$ lie in (in fact, generate), the kernel of

$$K_1(\mathbb{Z}_2 \times \pi_2)[\pi] \longrightarrow \text{Wh}_1(\pi_1; \mathbb{Z}_2 \times \pi_2).$$

Lemma 3.5. Renormalizing at an $i+1/i+1$ or i/i intersection preserves the class of $I + \sum M_j^{-1} A_j$ in $K_1(\mathbb{Z}_2 \times \pi_2)[\pi_1]$.

Proof. Consider an $i+1/i+1$ intersection of the $i+1$ -handle a_l over the $i+1$ -handle a_m , corresponding to M_k changing to $M_{k+1} = M_k e_{ml}^\sigma$. Renormalization adds $\alpha \in \mathbb{Z}_2 \times \pi_2$ to the $\mathbb{Z}_2 \times \pi_2$ invariant of each arc of $i+1/i$ intersection which abuts the given $i+1/i+1$ intersection. The algebraic number of such arcs is

given by the m^{th} column of M_k (which is also the m^{th} column of M_{k+1}), so A_k and A_{k+1} together are changed by adding $\alpha\sigma$ times the m^{th} column of M_k to their ℓ^{th} column, i.e., by adding $M_k d_{m\ell}^{\alpha\sigma}$.

The precise way in which this change is split between A_k and A_{k+1} , which depends on whether $i + 1/i$ arcs abutting the $i + 1/i + 1$ intersection lie to the left or to the right of the $i + 1/i + 1$ intersection, does not affect the resulting change in $I + \Sigma A_j M_j^{-1}$. For, if the new A'_k and A'_{k+1} are rewritten as,

$$A'_k + d_{p\ell}^x \quad \text{and} \quad A'_{k+1} - d_{p\ell}^x, \quad \text{then}$$

$$(A'_k + d_{p\ell}^x)M_k^{-1} + (A'_{k+1} - d_{p\ell}^x)M_{k+1}^{-1} - (A'_k M_k^{-1} + A'_{k+1} M_{k+1}^{-1}) = 0 \quad \text{since}$$

$$d_{p\ell}^x M_{k+1}^{-1} = d_{p\ell}^x e^{-\sigma} M_k^{-1} = d_{p\ell}^x M_k^{-1}.$$

Thus we may assume A_k changes to $A_k + M_k d_{m\ell}^{\alpha\sigma}$ and A_{k+1} is fixed. Then $I + \Sigma A_j M_j^{-1}$ becomes

$$I + \Sigma A_j M_j^{-1} + M_k d_{m\ell}^{\alpha\sigma} M_k^{-1} = (I + \Sigma A_j M_j^{-1})(I + M_k d_{m\ell}^{\alpha\sigma} M_k^{-1}), \quad \text{and the image in}$$

$K_1(\mathbb{Z}_2 \times \pi_2)[\pi_1]$ is unchanged.

The case of an i/i intersection is similar.

Remark. The obstruction $[I + \Sigma M_j^{-1} A_j]$ is clearly independent of

choice iv a), and it is probably independent of iv b) also, but we will not need this result. Note that iv b) was used only in the normalization at $i + 1/i + 1$ or i/i intersections, and then only for the π_2 factor.

Lemma 3.6. Subdivision of the t intervals preserves $I + \sum_j^{-1} A_j$.

Proof. Such subdivision of the k^{th} t interval splits A_k into $A_k^1 + A_k^2 = A_k$ and preserves the underlying M_k , so that $I + \sum_j^{-1} A_j$ is unchanged.

To complete the proof of the theorem it remains to show that $[I + \sum_j^{-1} A_j]$ is unchanged by a homotopy of f_t and its gradient-like vector field to another nice one-parameter family whose critical points are of index i and $i + 1$. Such a homotopy may itself be deformed, relative to its ends, to a nice two-parameter family having critical points of index i and $i + 1$ only, provided that n and i are large enough ($7 \leq i \leq n - 7$ suffices by V. 3.1 of [H-W]). If n and i are not already in this stable range we may use the suspension construction of I§5 of [H-W] which takes functions and vector fields on M to functions and vector fields on $M \times D^{2k}$, increasing the index of critical points by k . It is clear from the definition that this suspension preserves the matrix $I + \sum_j^{-1} A_j$.

Thus there is no loss of generality in restricting attention to homotopies of f_t involving only the indices i and $i + 1$. It

suffices then to show that each catastrophe on the following list leaves $[I + \sum_j^{-1} A_j]$ invariant:

I. Changes in the graphic

A. 

B. 

II. Changes in $i + 1/i + 1$ or i/i intersections

- A. Cancelling or introducing a pair of consecutive $i + 1/i + 1$ or i/i intersections
- B. Permuting two consecutive $i + 1/i + 1$ or i/i intersections
- C. Permuting an $i + 1/i + 1$ or i/i intersection and an adjacent birth-death point.
- D. An $i/i + 1$ intersection

III. Changes in the $i + 1/i$ intersections

- A. Surgery on the interior of an arc of $i + 1/i$ intersections
- B. Failure of an arc of $i + 1/i$ intersections to be transverse to a subdividing t slice.

(See V§5 for an argument showing that it is not necessary to consider the catastrophe occurring at a dovetail singularity:

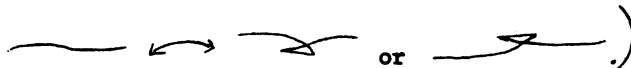

Lemma 3.7. Normalizations can be chosen for all functions in a small

two-parameter neighborhood of each of the catastrophes listed above. Hence the matrices A_j for t intervals in such neighborhoods of the catastrophes can be taken to be zero.

Proof. One proceeds just as in the one-parameter normalization of §2, the only appreciable difference being that now one has vertical alignments of up to four critical points connected by trajectories of the vector field.

Consider, for example, an $i/i + 1$ intersection:

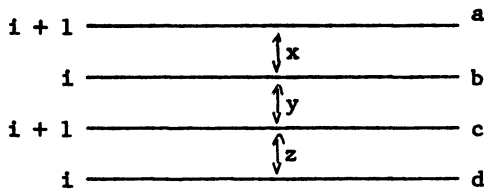

To obtain the π_2 normalizations one uses contractions of $\tilde{\lambda}(x)$, $\tilde{\lambda}(y)$, $\tilde{\lambda}(z)$ to get contractions of $\tilde{\lambda}(yx)$, $\tilde{\lambda}(zy)$, and $\tilde{\lambda}(zyx)$. For the \mathbb{Z}_2 part one looks in a level surface between b and c , where stable and unstable sets form manifolds with singularities of the type described in §2.

Further details will be left to the reader.

The conclusion of the proof of Theorem 3.1 follows easily from this lemma. For in every case except I.B. the only change in $I + \sum_j^{-1} A_j$ is a possible relabelling of the subscripts j , corresponding to the process of subdividing t intervals to allow all A_j

near the catastrophe to be zero.

In I. B. the splitting or joining of the arcs of critical points necessitates a certain change in basis for all the matrices M_j and A_j to the right of the catastrophe, say for $j > k$. Thus M_j and A_j are replaced by PM_jQ and PA_jQ for some $P, Q \in GL(\mathbb{Z}[\pi])$, $j > k$. And

$$I + \sum_{j \leq k} M_j^{-1} A_j = (I + \sum_{j \leq k} M_j^{-1} A_j) (I + \sum_{j > k} M_j^{-1} A_j) \text{ becomes}$$

$$(I + \sum_{j \leq k} M_j^{-1} A_j) Q^{-1} (I + \sum_{j > k} M_j^{-1} A_j) Q.$$

So the image in $K_1(\mathbb{Z}_2 \times \pi_2)[\pi]$ is unchanged.

§4. Product and Duality Formulae; Applications

The homomorphism θ of Theorem 3.1 depends on the indices i and $i + 1$ of the critical points of the given family f_* . This dependence will be expressed in this section by writing θ_{i+1} for the θ above.

Lemma 4.1. $\theta_{i+1} = -\theta_i$

Thus a definition of the second obstruction which is independent of indices is $\theta = (-1)^i \theta_i$.

The formula $\theta_{i+1} = -\theta_i$ would be a formal consequence of a general definition of the $Wh_1(\pi_1; \mathbb{Z}_2 \times \pi_2)$ invariant for nice one-parameter families with unrestricted indices, such as is given in [H-W] for the $Wh_2\pi_1$ invariant. Such a definition of the second

obstruction can in fact be given, although the proof of Theorem 3.1 then becomes much more complicated. (The complication is more than just formal; Lemma 3.7 is no longer valid in the case of an $i/i + 1$ intersection when critical points of index $i - 1$ or $i + 2$ are present.) We shall content ourselves here with an ad hoc proof of Lemma 4.1 for the special case of one-parameter families with vanishing $Wh_2\pi_1$ invariant, i.e., with graphic (stably) reducible to

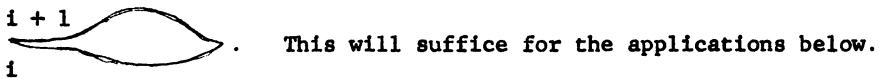

In this special case it is sufficient to construct a deformation family carrying a one-parameter with empty graphic to one with graphic:

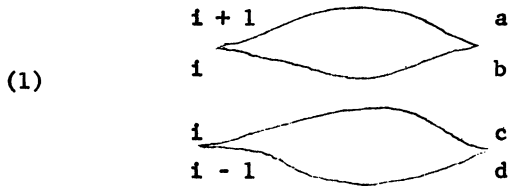

both components of which have prescribed $i + 1/i$ or $i/i - 1$ invariant $\alpha \sigma \in (\mathbb{Z}_2 \times \pi_2)[\pi_1]$. To do this, first introduce critical points with the graphic (1) and with a/b and c/d intersections one point in each t slice and all other intersections empty. Next introduce a pair of i/i intersections of b over c so that a/c and b/d intersections become one point in each t slice between

the two i/i intersections, where the algebraic a/c (b/d) intersection number is $-1 \in \mathbb{Z}[\pi_1]$ (respectively, $+1 \in \mathbb{Z}[\pi_1]$). Now, preserving the vector field, change the graphic to:

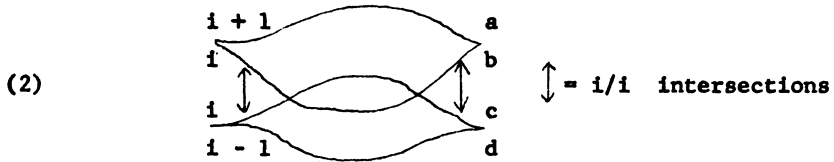

In a level surface between c and b for t slices between the two crossings of the graphic one then has the stable manifolds D_a^i and $S_c^{i-1} = \partial D_a^i$ and the unstable manifolds D_d^{n-i+1} and $S_b^{n-i} = \partial D_d^{n-i+1}$.

Deform the vector field through a second parameter in such a way as to pass through a circle of c/b intersections with one-dimensional intersection invariant $\alpha\sigma$. (We are free to suspend as in I§5 of [H-W] to make i and $n-i$ large enough so that this deformation is possible; see [H-Q].) Then necessarily the result of this deformation has a/b and c/d intersections each with the invariant $\alpha\sigma$. For the a/b intersections with zero-dimensional invariant $\sigma \in \pi_1$ (we may assume $\sigma \neq 1$) for the two-parameter family form a bordism between the circle of c/b intersections and the resulting a/b intersections, and $\alpha\sigma$ is by definition a bordism

invariant. Similarly for the c/d intersections.

The graphic can then be returned to the form (1), preserving the vector field, so that each component of the graphic has the desired invariant $\alpha\sigma$.

An immediate consequence of Lemma 4.1 is the product formula for the second obstruction. Let N be a smooth closed manifold and $F \in \mathcal{P}(M, \partial M)$, so that $F \times \text{id}_N \in \mathcal{P}(M \times N, \partial M \times N)$. Denote by i_* the map on $Wh_1(\pi_1; \mathbb{Z}_2 \times \pi_2)$ induced from $i: M \hookrightarrow M \times N$.

Product Formula 4.2. $\theta([F \times \text{id}_N]) = \chi(N) i_*\theta([F])$, where $\chi(N)$ is the Euler characteristic of N .

The proof is formally the same as in the case of the $Wh_2\pi_1$ invariant. See VIII of [H-W].

If $F \in \mathcal{P}(M, \partial M)$, let $\bar{F}: M \times I \longrightarrow M \times I$ be the "dual" pseudo-isotopy obtained from F by reversing the ends of the interval I , and then composing with the constant isotopy $F^{-1}|_{M \times \{1\}}$ so that $\bar{F} \in \mathcal{P}(M, \partial M)$. To compute $\theta([\bar{F}])$ in terms of $\theta([F])$ we may use the one-parameter family $1-f_t$ having critical points of index $n - 1$ and $n - 1 + 1$ and gradient-like vector field $-\mu_t$, where f_t , having critical points of index i and $i + 1$ and vector field μ_t , is used to compute $\theta([F])$. Thus $\theta([F]) = (-1)^{i+1} \theta_{i+1}([F])$, and $\theta_{i+1}([F]) = [I + \sum_j^{-1} A_j]$ is defined as in §2.

Lemma 4.3. Reversing the ends of I changes $M_j = (m_{kl}^j)$ and

$A_j = (a_{k\ell}^j)$ to $\bar{M}_j = (\bar{m}_{\ell k}^j)$ and $\bar{A}_j = (\bar{a}_{\ell k}^j)$, where the involution $m \mapsto \bar{m}$ of $\mathbb{Z}[\pi_1 M]$ is given by $\sigma \mapsto W_1(\sigma)\sigma^{-1}$, while the involution $\alpha \mapsto \bar{\alpha}$ of $(\mathbb{Z}_2 \times \pi_2 M)[\pi_1 M]$ takes the form

$$(\alpha_1 \alpha_2) \sigma \mapsto (\alpha_1 + W_2(\alpha_2), -W_1(\sigma) \alpha_2^{\sigma^{-1}}) \sigma^{-1} \text{ for } \alpha_1 \in \{0,1\} \approx \mathbb{Z}_2, \\ \alpha_2 \in \pi_2 M, \text{ and } \sigma \in \pi_1 M.$$

Here $W_1: \pi_1 M \rightarrow \{\pm 1\}$ and $W_2: \pi_2 M \rightarrow \{0,1\}$ are the "Stiefel-Whitney classes" which classify the restriction of the tangent bundle of M to a circle or two-sphere representing a given element of $\pi_1 M$ or $\pi_2 M$.

Proof. Referring to figure 1 of §2, we see that the first effect of reversing the ends of I is to replace $\lambda(x)$ by $\lambda^{-1}(x)$ and hence σ by σ^{-1} . In addition, to compute the $\pi_2 M$ component the loops $\tilde{\lambda}(x) = g^{-1}([\lambda(x)])\lambda(x)$ are to be replaced by the loops $g^{-1}([\lambda^{-1}(x)])\lambda^{-1}(x) = g^{-1}([\lambda^{-1}(x)]) [g([\lambda^{-1}(x)])\lambda(x)]^{-1} g([\lambda^{-1}(x)])$. These determine the same element of $\pi_2 M$ as the loops $g([\lambda(x)]) [g^{-1}([\lambda(x)])\lambda(x)]^{-1} g^{-1}([\lambda(x)])$; namely $-\alpha_2^{\sigma^{-1}}$.

To account for W_1 and W_2 we must consider the zero-dimensional and one-dimensional framing invariants in $\Omega_0^{fr}(\ast)$ and $\Omega_1^{fr}(\ast)$. These are defined by comparing the canonical framings of $\nu(S_a^i, V)$ and $\tau(S_b^{n-1})$ at an $i + 1/i$ intersection point x . Dually

we would frame $\nu(S_b^{n-1}, V)$ and $\tau(S_a^1)$ at x . The product of these framings is a pair of framings of V or, stabilizing by $V \subset M \times I$, a pair of framings of $M \times I$ at x . These are just the translations of the orientation frame of $M \times I$ at the basepoint $*$ along $\gamma(a)$ and $\gamma(b)$. The difference between these two framings is the element of $\pi_0 O(n+1)$ classifying $\tau(M \times I)|_{\lambda(x)}$, i.e., $W_1(\sigma)$ or, for an arc C of $i+1/i$ intersections, the element of $\pi_1 O(n+1)$ classifying $\tau(M \times I)|_{\tilde{\lambda}(C)}$, i.e., $W_2(\alpha_2)$. Thus dualizing multiplies the zero-dimensional intersection number in \mathbb{Z} by $W_1(\sigma)$ and adds $W_2(\alpha_2)$ to the one-dimensional intersection invariant in $\mathbb{Z}_2 = \{0, 1\}$.

The involution $I + (a_{kl}) \longrightarrow I + (\bar{a}_{lk})$ of

$GL((\mathbb{Z}_2 \times \pi_2 M)[\pi_1 M])$ passes to an involution of $Wh_1(\pi_1 M; \mathbb{Z}_2 \times \pi_2 M)$

denoted $\theta \longmapsto \bar{\theta}$. The lemma implies that

$$\theta_{n-i+1}([\bar{F}]) = [I + \Sigma \bar{A}_j \bar{M}_j^{-1}] = \overline{[I + \Sigma M_j^{-1} A_j]} = \bar{\theta}_{i+1}([F]). \text{ Hence}$$

$$\theta([\bar{F}]) = (-1)^{n-i+1} \theta_{n-i+1}([\bar{F}]) = (-1)^n (-1)^{i+1} \theta_{i+1}([F]) = (-1)^{n-\theta}([F])$$

and we have derived the following:

Duality Formula 4.4. $\theta([\bar{F}]) = (-1)^{n-\theta}([F])$, where $n = \dim M$.

We now give two simple applications of the duality formula, restricting attention to the factor $Wh_1(\pi_1; \mathbb{Z}_2)$ of $Wh_1(\pi_1; \mathbb{Z}_2 \times \pi_2)$.

Recall from VII of [H-W] that $\pi_0 \rho(M, \partial M) \longrightarrow Wh_1(\pi_1; \mathbb{Z}_2)$ is

surjective if $\dim M \geq 5$.

Let $\text{Diff}(M \times I, \partial) \subset \mathcal{P}(M, \partial M)$ denote the subgroup (with the induced C^∞ topology) of diffeomorphisms of $M \times I$ which are the identity on $\partial(M \times I)$.

Corollary 4.5. If $\pi_1 M$ contains an element σ not conjugate to σ^{-1} and $\dim M \geq 5$, then in $\text{Diff}(M \times I, \partial)$ there exist diffeomorphisms pseudo-isotopic to the identity but not isotopic to it.

Proof. Let $F \in \mathcal{P}(M, \partial M)$ have $\text{Wh}_1(\pi_1 M; \mathbb{Z}_2)$ invariant represented by $\sigma \in \pi_1 M \subset \mathbb{Z}_2[\pi_1 M]$ under the isomorphism of Corollary 1.3. Then the "double" $2F \in \text{Diff}(M \times I, \partial)$, obtained by compressing F into $M \times [0, \frac{1}{2}]$ and then on $M \times [\frac{1}{2}, 1]$ using the reflection of this through $M \times \{\frac{1}{2}\}$, has $\text{Wh}_1(\pi_1 M; \mathbb{Z}_2)$ invariant the sum of the invariants for F and \bar{F} , i.e., $[\sigma + \sigma^{-1}]$. By hypothesis $[\sigma + \sigma^{-1}]$ is non-zero in $\text{Wh}_1(\pi_1 M; \mathbb{Z}_2)$, so $2F$ is not isotopic to the identity in $\mathcal{P}(M, \partial M)$ nor, a fortiori, in $\text{Diff}(M \times I, \partial)$. But $2F$ is pseudo-isotopic in $\text{Diff}(M \times I, \partial)$ to the identity. In fact, $2F$ is the restriction to $M \times I \times \{1\}$ of the suspension $SF \in \mathcal{P}(M \times I, \partial(M \times I))$ as defined in I§5 of [H-W].

Corollary 4.5 has the following quantitative refinement:

Corollary 4.6. The abelian group $\pi_0 \text{Diff}(M \times I, \partial)$ is not finitely generated if $\dim M \geq 5$ and $\pi_1 M$ contains infinitely many conjugacy classes which are distinct from their inverse classes.

This condition on $\pi_1 M$ is satisfied, for example, if $\pi_1 M$ maps homomorphically onto \mathbb{Z} . An interesting special case for both corollaries is $M = S^1 \times D^{n-1}$, $n \geq 5$. In fact, one can completely compute $\pi_0 \text{Diff}(S^1 \times D^{n-1}, \partial)$ for $n \geq 7$. This will be done in the next section.

§5 Pseudo-isotopy versus Isotopy

In this section we indicate some things that the computation of $\pi_0 \mathcal{P}(M, \partial M)$ implies about $\pi_0 \text{Diff}(M, \partial)$. Only in very special cases however can we give a complete answer, for example when $M = S^1 \times D^{n-1}$

Let $\text{Diff}(M, \partial)$ be the group of diffeomorphisms of M which restrict to the identity on ∂M , and let $\text{Diff}_I(M, \partial)$ ($\text{Diff}_{PI}(M, \partial)$) be the normal subgroup of diffeomorphisms isotopic (respectively, pseudo-isotopic) to the identity in $\text{Diff}(M, \partial)$. One then has the fundamental exact sequence:

$$\begin{array}{ccccccc}
 0 & \longrightarrow & \frac{\text{Diff}_{PI}(M, \partial)}{\text{Diff}_I(M, \partial)} & \longrightarrow & \frac{\text{Diff}(M, \partial)}{\text{Diff}_I(M, \partial)} & \longrightarrow & \frac{\text{Diff}(M, \partial)}{\text{Diff}_{PI}(M, \partial)} \longrightarrow 0 \\
 (*) & & \parallel & & \parallel & & \parallel \\
 0 & \longrightarrow & \pi_0 \text{Diff}_{PI}(M, \partial) & \longrightarrow & \pi_0 \text{Diff}(M, \partial) & \longrightarrow & \tilde{\pi}_0 \text{Diff}(M, \partial) \longrightarrow 0
 \end{array}$$

Proposition 5.1. $\pi_0 \text{Diff}_{PI}(M, \partial) \cong \text{Coker}(j)$, where

$j: \pi_0 \text{Diff}(M \times I, \partial) \longrightarrow \pi_0 \mathcal{P}(M, \partial M)$ is induced by inclusion.

Proof: The quotient group $\mathcal{P}(M, \partial M) / \text{Diff}(M \times I, \partial)$ is naturally identified with $\text{Diff}_{PI}(M, \partial)$.

Thus the basic question is, what is $\text{Im}(j)$? In other words, which $\text{Wh}_2\pi_1$ and $\text{Wh}_1(\pi_1; \mathbb{Z}_2 \times \pi_2)$ invariants arise from pseudo-isotopies of the identity to itself? In general this is undoubtedly a very hard question, just like the analogous question for h-cobordisms: When are the two ends of an h-cobordism diffeomorphic?

For the remainder of this section we will assume $n = \dim M \geq 7$, and $\pi_0 \mathcal{P}(M, \partial M)$ will be identified with $\text{Wh}_2\pi_1 M \oplus \text{Wh}_1(\pi_1 M; \mathbb{Z}_2 \times \pi_2 M)$. On $\text{Wh}_2\pi_1 \oplus \text{Wh}_1(\pi_1; \mathbb{Z}_2 \times \pi_2)$ let the differential d_i be given by $d_i(x) = x - (-1)^i \bar{x}$, and let $Z_i = \text{Ker}(d_i)$, $B_i = \text{Im}(d_{i+1})$. Thus $B_i = \{x + (-1)^i \bar{x}\}$ and $Z_i = \{x = (-1)^i \bar{x}\}$. By the "double" construction of 4.5 we have:

Lemma 5.2. $\text{Im}(j) \supset B_n$ ($n = \dim M$).

In general that may be all that can be said about $\text{Im}(j)$.

Lemma 5.3. If $M^n = N^{n-1} \times I$, then $\text{Im}(j) \subset Z_n$.

Proof. If $F \in \text{Diff}(M \times I, \partial)$, consider the pseudo-isotopy \tilde{F} obtained by rotating F halfway around in the I^2 factor of $M \times I = N \times I^2$: \tilde{F} is not quite the dual \bar{F} of F , but \tilde{F} differs from \bar{F} only by conjugation by the involution of $M = N \times I$ which reverses the ends of I . Such conjugation induces the identity on $\pi_* M$, hence also on $\pi_0 \mathcal{P}(M, \partial M)$, so \bar{F} and \tilde{F} determine the same element of $\pi_0 \mathcal{P}(M, \partial M)$. By construction \tilde{F} is isotopic to F in $\mathcal{P}(M, \partial M)$, and the result follows.

Proposition 5.4. (a) If $M^n = N^{n-1} \times I$ and $B_n = Z_n$, then

$$\pi_0 \text{Diff}_{PI}(M, \partial) \approx B_{n-1}.$$

(b) If in addition $N^{n-1} = Q^{n-2} \times I$ and $B_{n-1} = Z_{n-1}$, then the sequence (*) splits.

Proof. (a) We have $\pi_0 \text{Diff}_{PI}(M, \partial) \approx \text{Coker}(j) \approx \text{Coker}(d_{n+1}) \approx B_{n-1}$, with the composite map given by

$$\pi_0 \text{Diff}_{PI}(M, \partial) \longrightarrow \pi_0 \mathcal{F}(N, \partial N) \longrightarrow \text{Wh}_2 \pi_1 \oplus \text{Wh}_1(\pi_1; \mathbb{Z}_2 \times \pi_2).$$

(b) Consider the map

$$\pi_0 \text{Diff}(M, \partial) \longrightarrow \pi_0 \mathcal{F}(N, \partial) \longrightarrow \text{Wh}_2 \pi_1 \oplus \text{Wh}_1(\pi_1; \mathbb{Z}_2 \times \pi_2).$$

The arguments of the preceding two lemmas applied to N instead of M show that this has image B_{n-1} , hence is the desired splitting.

The algebraic hypotheses of this proposition are satisfied if π_1 is free or free abelian (so that $\text{Wh}_2 \pi_1 = 0$ by recent results of Quillen and Gersten) and, say, $\pi_2 = 0$. In this case $\text{Wh}_1(\pi_1; \mathbb{Z}_2)$ and B_{n-1} are both infinite sums of copies of \mathbb{Z}_2 . For example, when $\pi_1 = \mathbb{Z}$ with generator T , then

$$\text{Wh}_1(\mathbb{Z}; \mathbb{Z}_2) \approx \mathbb{Z}_2^o[T, T^{-1}] \text{ and } B_{n-1} \approx \mathbb{Z}_2^o[T + T^{-1}], \text{ where the superscript "o" denotes polynomials with vanishing constant term.}$$

Corollary 5.5. $\pi_0 \text{Diff}_{PI}(S^1 \times D^{n-1}, \partial) \approx \bigoplus_1^\infty \mathbb{Z}_2$ and

$$\pi_0 \text{Diff}(S^1 \times D^{n-1}, \partial) \approx \bigoplus_1^\infty \mathbb{Z}_2 \oplus \Gamma^n \oplus \Gamma^{n+1} \quad (n \geq 7).$$

The second statement follows from the computation of $\text{Diff}(S^1 \times D^{n-1}, \partial)$ modulo pseudo-isotopy, as in [Br] and [T].

HATCHER

($\Gamma^n \approx \pi_0 \text{Diff}(D^{n-1}, \partial)$ and $\Gamma^{n+1} \approx \pi_0 \text{Diff}(D^n, \partial)$ are mapped to $\pi_0 \text{Diff}(S^1 \times D^{n-1}, \partial)$ in the obvious way.)

References

- [B] H. Bass, Algebraic K-theory, Benjamin 1968.
- [Br] W. Browder, Diffeomorphisms of 1-connected manifolds, Transactions A.M.S. 128(1967) 155-163.
- [H-Q] A. Hatcher and F. Quinn, Bordism invariants of intersections of submanifolds, to appear.
- [H-W] A. Hatcher and J. Wagoner, Pseudo-isotopies on non-simply connected manifolds and the functor K_2 , this volume.
- [M] J. Milnor, Introduction to algebraic K-theory. Annals of Math. Study #72, 1971.
- [S] R. G. Swan, Excision in algebraic K-theory, J. Pure & Appl. Algebra, 1(1971) 221-252.
- [T] E. C. Turner, Diffeomorphisms of a product of spheres, Invent. Math. 8(1969) 69-82.

Princeton University
August, 1972