

ANNALES DE L'I. H. P., SECTION C

CARLOS GUTIERREZ

A solution to the bidimensional global asymptotic stability conjecture

Annales de l'I. H. P., section C, tome 12, n° 6 (1995), p. 627-671

http://www.numdam.org/item?id=AIHPC_1995__12_6_627_0

© Gauthier-Villars, 1995, tous droits réservés.

L'accès aux archives de la revue « Annales de l'I. H. P., section C » (<http://www.elsevier.com/locate/anihpc>) implique l'accord avec les conditions générales d'utilisation (<http://www.numdam.org/conditions>). Toute utilisation commerciale ou impression systématique est constitutive d'une infraction pénale. Toute copie ou impression de ce fichier doit contenir la présente mention de copyright.

NUMDAM

Article numérisé dans le cadre du programme
Numérisation de documents anciens mathématiques

<http://www.numdam.org/>

A solution to the bidimensional Global Asymptotic Stability Conjecture

by

Carlos GUTIERREZ

IMPA, Rio de Janeiro

ABSTRACT. – If $Y : \mathfrak{R}^2 \rightarrow \mathfrak{R}^2$ is a C^1 vector field such that $Y(0) = 0$ and, for all $q \in \mathfrak{R}^2$, all the eigenvalues of $DX(q)$ have negative real part, then the stable manifold of 0 is \mathfrak{R}^2 .

Let $\rho \in [0, \infty)$ and $Y : \mathfrak{R}^2 \rightarrow \mathfrak{R}^2$ be a C^1 map such that, for all $q \in \mathfrak{R}^2$, the determinant of $DY(q)$ is positive and moreover, for all $p \in \mathfrak{R}^2$, with $|p| \geq \rho$, the spectrum of $DY(p)$ is disjoint of the non-negative real half axis. Then Y is injective.

Key words: Asymptotic stability, Univalent maps.

RÉSUMÉ. – Si $Y : \mathfrak{R}^2 \rightarrow \mathfrak{R}^2$ est un champ de vecteur tel que $Y(0) = 0$ et, pour tout $q \in \mathfrak{R}^2$, les valeurs propres de $DY(q)$ ont leur partie réelle négative, alors la variété stable de 0 est \mathfrak{R}^2 .

Soit $\rho \in [0, \infty)$ et $Y : \mathfrak{R}^2 \rightarrow \mathfrak{R}^2$ une application C^1 telle que, pour tout $q \in \mathfrak{R}^2$, le déterminant de $DY(q)$ est positif et de plus, pour tout $p \in \mathfrak{R}^2$, avec $|p| \geq \rho$, le spectre de $DY(p)$ est disjoint du demi-axe réel non négatif. Alors Y est injective.

1. INTRODUCTION

This work is related to the conjecture about global asymptotic stability which claims that if a C^1 vector field $Y : \mathfrak{R}^n \rightarrow \mathfrak{R}^n$ has a singularity p

A.M.S. Classification: (34) Ordinary differential equations; (58) Global analysis, analysis on manifolds.

and, for every $q \in \mathfrak{R}^n$, all the eigenvalues of $DY(q)$ have negative real part then the basin of attraction of p is the whole \mathfrak{R}^n . This conjecture was explicitly stated by Marcus and Yamabe [12] in 1960. Also, it somehow stems from the Aizerman Problem [10], [1] (1949). Barabanov [2] proved that this conjecture is false if $n \geq 4$. Here we prove that it is true if $n = 2$.

In the bidimensional case, the conjecture above has been solved affirmatively under additional conditions since Krasovskii's work [11]. Markus and Yamabe [12] considered the case where one of the partial derivatives of Y vanishes identically. Hartmann [8] solved the problem when $DY(x) + DY(x)^T$ is everywhere negative definite, where T means transposition. Olech [15] proved the conjecture when there exist constants $\delta > 0$ and $R > 0$ such that $|x| > R$ implies that $|Y(x)| > \delta$. By the work of Meisters and Olech, the conjecture was known to be true for polynomial vector fields [14]. The fact that the assumptions in the conjecture are to be global is completely justified by the examples of [7].

In higher dimensions and under additional hypotheses, there are also positive answers. There is a rich literature on the subject; we suggest the reader [13] for further references and history of the problem. Also Hartman's book [9] deals with this question. Concerning some recent previous results we wish to mention the works of Gasull, Llibre and Sotomayor [4], Gasull and Sotomayor [5], and Gorni and Zampieri [6].

Let us proceed to state, in a more precise way, the results of this paper.

Let $\rho \in [0, \infty)$ and let $Y : \mathfrak{R}^2 \rightarrow \mathfrak{R}^2$ be a map of class C^1 . We say that Y satisfies the ρ -eigenvalue condition if, for all $q \in \mathfrak{R}^2$, the determinant of $DY(q)$ is positive and moreover, for all $p \in \mathfrak{R}^2$, with $|p| \geq \rho$, the spectrum of $DY(p)$ is disjoint of the non-negative real half axis.

THEOREM A. – *If $Y : \mathfrak{R}^2 \rightarrow \mathfrak{R}^2$ is a map of class C^1 that satisfies the ρ -eigenvalue condition, for some $\rho \in [0, \infty)$, then Y is injective.*

THEOREM B. – *Let $Y : \mathfrak{R}^2 \rightarrow \mathfrak{R}^2$ be a vector field of class C^1 such that, for all $q \in \mathfrak{R}^2$, all the eigenvalues of $DX(q)$ have negative real part. If Y has a singularity, say p , then the stable manifold of p is \mathfrak{R}^2 .*

Theorem B is the solution to the Global Asymptotic Stability Conjecture.

A very interesting results of injectivity of maps, based on spectral conditions too, have been found by B. Smith and F. Xavier [16].

In Theorem A, we shall assume that Y is at least C^2 . It is enough to prove it under these conditions. In fact, first observe that, by the assumptions and the Inverse Mapping Theorem, non-injectivity is an open condition. Therefore, if there was a non-injective C^1 map satisfying the ρ -eigenvalue condition, it could be approximated (in the Whitney topology) by a smooth map that would have both of these two properties.

Theorem B is a direct consequence of Theorem A and the Olech's Theorem [15] that states that if the assumptions in Theorem B imply that Y is injective, then the conclusion of Theorem B is true.

This work contains two more important results, Theorems C and D, stated at the beginning of Section 2 below. I wish to thank J. Llibre, A. Gasull and M. Wattenberg for very important comments. I wish also to thank A. Katok, R. de la Llave, C. Pugh and R. Roussarie for very helpful conversations. Sometime after the present work was completed, I took knowledge that Robert Fessler [3] was obtaining similar results.

2. THE HALF-REEB COMPONENTS

Let $\rho \in [0, \infty)$. Any map $Y = (f, g)$, as above, satisfying the ρ -eigenvalue condition, possesses the ρ -obstruction property: For all $(x, y) \in \mathfrak{R}^2$, with $|(x, y)| \geq \rho$,

$$\nabla f(x, y) \notin (0, \infty) \times \{0\}.$$

Given a smooth regular curve $\gamma : [a, b] \rightarrow \mathfrak{R}^2$ (resp. a smooth function $f : \mathfrak{R}^2 \rightarrow \mathfrak{R}$) and $t \in [a, b]$ (resp. $q \in \mathfrak{R}^2$), we shall denote by $\gamma'(t)^\perp$ (resp. by $\nabla f^\perp(q)$) the vector field of \mathfrak{R}^2 having the same length as $\gamma'(t)$ (resp. $\nabla f(p)$), being orthogonal to $\gamma'(t)$ (resp. $\nabla f(p)$) and such that $\{\gamma'(t), \gamma'(t)^\perp\}$ (resp. $\{\nabla f(p), \nabla f^\perp(p)\}$) is a positive basis of \mathfrak{R}^2 .

Let D be a smooth bidimensional submanifold of \mathfrak{R}^2 with boundary and, possibly, corner ∂D . Let $\gamma : [a, b] \rightarrow \partial D$ be a smooth regular curve. We say that D is *on the left*, or more precisely, *on the left side of γ* (resp. *on the right* of γ), if for all $s \in (a, b)$, or equivalently for some $s \in (a, b)$, $\gamma'(s)^\perp$ points inward D (resp. $\gamma'(s)^\perp$ points outward D).

Throughout this work, $X = (f, g) : \mathfrak{R}^2 \rightarrow \mathfrak{R}^2$ will denote a C^2 map satisfying the ρ -eigenvalue condition, for some $\rho \in [0, \infty)$. Given $p \in \mathfrak{R}^2$, denote by $F_p = F_p(t)$, $t \in \mathfrak{R}$, the trajectory of ∇f^\perp such that $F_p(0) = p$. Also, $F_p^+ = F_p^+(t)$ and $F_p^- = F_p^-(t)$, $t \in \mathfrak{R}$, will denote the positive and negative half-trajectories of ∇f^\perp , respectively, starting at p .

Given $\theta \in \mathfrak{R}$, denote by

$$H_\theta = \begin{pmatrix} \cos \theta & -\sin \theta \\ \sin \theta & \cos \theta \end{pmatrix}$$

In this way

$$H_\theta^{-1} = \begin{pmatrix} \cos \theta & \sin \theta \\ -\sin \theta & \cos \theta \end{pmatrix}$$

Let $X_\theta = H_\theta \circ X \circ H_\theta^{-1} = (f_\theta, g_\theta)$.

Remark. – For all $\theta \in \mathfrak{X}$, X_θ satisfies the ρ -eigenvalue condition and therefore the ρ -obstruction property.

In fact, this follows immediately from:

$$DX_\theta(x, y) = H_\theta \circ DX_{H_\theta^{-1}(x, y)} \circ H_\theta^{-1}.$$

It will be seen that the proof of Theorem A, depends only on the Remark above and on the fact that $DX(p)$ is invertible, for all $p \in \mathfrak{X}^2$. For this reason, it will become clear that the arguments of this work apply, almost word for word, to give the following more general result:

THEOREM C. – *Let $Y : \mathfrak{X}^2 \rightarrow \mathfrak{X}^2$ be a C^1 map such that, for all $p \in \mathfrak{X}^2$, $DY(p)$ is invertible. Suppose that there exists $v \in \mathfrak{X}^2$, with $\|v\| = 1$, such that the following (directional) obstruction property is satisfied: For all $\theta \in \mathfrak{X}$ and for all $p \in \mathfrak{X}^2$, with $|p| \geq \rho$,*

$$\nabla \tilde{f}_\theta(p) \cdot v \neq \|\nabla \tilde{f}_\theta(p)\|$$

where, $(\tilde{f}_\theta, \tilde{g}_\theta) = H_\theta \circ Y \circ H_\theta^{-1}$.

Then, Y is injective.

Theorem A is a particular case of Theorem C because if $v = (1, 0)$ in Theorem C, then (for all $\theta \in \mathfrak{X}$) Y_θ satisfies the ρ -obstruction property.

Given $p, q \in \mathfrak{X}^2$, $[p, q]$ will denote a non-necessarily oriented segment connecting p and q . If γ is a curve and $p, q \in \gamma$, $[p, q]_\gamma$ (resp. $(p, q)_\gamma$) will denote the closed (resp. open) subinterval of γ with endpoints p and q . The notation $[p, q]_{f_\theta}$ and $(p, q)_{f_\theta}$ will refer to arcs of trajectory of ∇f_θ^\perp .

Let $\mu : (0, 2) \rightarrow \mathfrak{X}$ be a smooth map with $\mu'(1) = \mu(1) = 0$, $\mu''(1) < 0$ and $\mu'(x) \neq 0$ for all $x \neq 1$ (in particular, 1 is the absolute maximum value of μ). Suppose also that $\lim_{x \rightarrow 0} \mu(x) = \lim_{x \rightarrow 2} \mu(x) = -\infty$. Let \mathcal{G} be the foliation on $[0, 2] \times \mathfrak{X}$ whose leaves are $\{0\} \times \mathfrak{X}$, $\{2\} \times \mathfrak{X}$ and the family of the graphs of the functions $\mu + c$, where $c \in \mathfrak{X}$. This foliation \mathcal{G} is usually known as a *Reeb component*. We say that $A \subset \mathfrak{X}^2$ is a *Half-Reeb component* of ∇f^\perp if the foliation on A determined by the trajectories of ∇f^\perp is topologically equivalent to the foliation \mathcal{G} (just defined above) restricted to the manifold with boundary and corner $[0, 2] \times [0, \infty)$ in such a way that if

$$h : [0, 2] \times [0, \infty) \rightarrow A$$

is the homeomorphism producing the topological equivalence and if $p_i = h((i, 0))$, then $[p_0, p_2] = h([0, 2] \times \{0\})$ is a smooth segment

transversal to ∇f^\perp in the complement of $\{p_1\}$ and also, for some $\delta \in \{-, +\}$, $F_{p_0}^\delta = h(\{0\} \times [0, \infty))$ and $F_{p_2}^{-\delta} = h(\{2\} \times [0, \infty))$. See fig. 2.1.

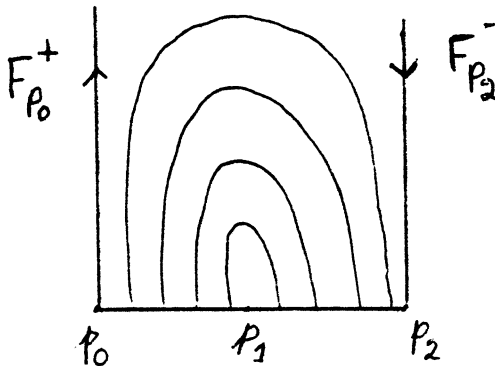

FIG. 2.1

Denote by $\partial_1 A$ the union of the half-trajectories $F_{p_0}^\delta$ and $F_{p_2}^{-\delta}$ and the segment $[p_0, p_2]$ which will be called *edges of A*. Observe that A may not be a closed subset of \mathbb{R}^2 .

The main result of this section is the following

PROPOSITION 2.1. – *There is no smooth regular curve $\gamma : [0, 3] \rightarrow \mathbb{R}^2$ such that the following properties are satisfied:*

(a) *For some $1 < s \leq t < 2$, γ is transversal to ∇f^\perp at all the points of $[0, 1] \cup [s, t] \cup [2, 3]$.*

(b) *$\gamma([1, s])$ and $\gamma([t, 2])$ are the compact edges of two half-Reeb components of ∇f^\perp which are both either on the left of γ or on the right of γ .*

See in figure 2.2 the situation that cannot occur.

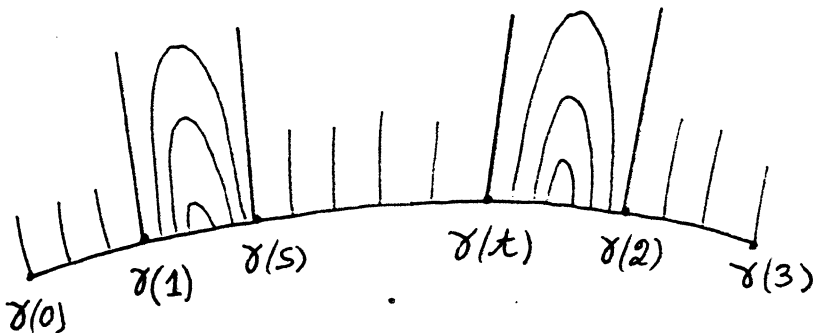

FIG. 2.2

The ρ -obstruction property is only used to prove Proposition 2.1. For this reason, it will become clear that the arguments of this work apply, word for word, to give the following more general result:

THEOREM D. – *Let $Y : \mathfrak{X}^2 \rightarrow \mathfrak{X}^2$ be a C^1 map such that, for all $p \in \mathfrak{X}^2$, $DY(p)$ is invertible and, for all $\theta \in \mathfrak{X}$, $\nabla \tilde{f}_\theta^\perp$ satisfies the same properties as ∇f^\perp does in Proposition 2.1, where $Y_\theta = H_\theta \circ Y \circ H_\theta^{-1} = (\tilde{f}_\theta, \tilde{g}_\theta)$. Then, Y is injective.*

To prove Proposition 2.1 we shall need Lemmas 2.2-2.6.

LEMMA 2.2. – (a) *For all $p \in \mathfrak{X}^2$, the function*

$$\varphi(\theta) = \det(H_\theta(\nabla f^\perp(p)), \nabla f_\theta^\perp(H_\theta(p)))$$

satisfies $\varphi(0) = 0$ and $\varphi'(0) = -\det(DX(p))$, where $(H_\theta(\nabla f^\perp(p))$ and $\nabla f_\theta^\perp(H_\theta(p))$ are to be the first and second column vector of the considered matrix. In other words, for small $\theta > 0$ fixed, the speed vector $(H_\theta(\nabla f^\perp(p))$ of the curve $t \rightarrow H_\theta(F_p^+(t))$, at the point $H_\theta(p)$, and $\nabla f_\theta^\perp(H_\theta(p))$ form a negative basis.

(b) *Let $p \in \mathfrak{X}^2$ and $0 < \theta < \pi$ be fixed but arbitrary. The level curves of f_θ are transversal to $H_\theta(F_p)$.*

Proof. – Given $v = (v_1, v_2), w = (w_1, w_2) \in \mathfrak{X}^2$, we shall denote by

$$\begin{aligned} (v, w) &= \begin{pmatrix} v_1 & w_1 \\ v_2 & w_2 \end{pmatrix} \\ \begin{pmatrix} v \\ w \end{pmatrix} &= \begin{pmatrix} v_1 & v_2 \\ w_1 & w_2 \end{pmatrix} \end{aligned}$$

Recall also that $v^\perp = (-v_2, v_1)$. The following holds:

$$(1) \quad \begin{cases} \begin{pmatrix} v^\perp \\ w^\perp \end{pmatrix} = \begin{pmatrix} v \\ w \end{pmatrix} \begin{pmatrix} 0 & 1 \\ -1 & 0 \end{pmatrix} \\ \begin{pmatrix} -v \\ -w \end{pmatrix} = \begin{pmatrix} v^\perp \\ w^\perp \end{pmatrix} \begin{pmatrix} 0 & 1 \\ -1 & 0 \end{pmatrix} \\ \begin{pmatrix} -w \\ v \end{pmatrix} = \begin{pmatrix} 0 & -1 \\ 1 & 0 \end{pmatrix} \begin{pmatrix} v \\ w \end{pmatrix} \end{cases}$$

Observe that

$$(2) \quad \begin{cases} \frac{d}{d\theta} H_\theta|_{\theta=0} = \begin{pmatrix} 0 & -1 \\ 1 & 0 \end{pmatrix} \\ \text{and} \\ \frac{d}{d\theta} H_\theta^{-1}|_{\theta=0} = \begin{pmatrix} 0 & 1 \\ -1 & 0 \end{pmatrix} \end{cases}$$

As

$$\begin{aligned} \frac{d}{d\theta}(H_\theta(\nabla f^\perp(x, y)))|_{\theta=0} &= \left(\frac{d}{d\theta}H_\theta\right)(\nabla f^\perp(x, y)) \\ &= \begin{pmatrix} 0 & -1 \\ 1 & 0 \end{pmatrix}(\nabla f^\perp(x, y)) \\ &= -\nabla f(x, y) \end{aligned}$$

We have that

$$(3) \quad \frac{d}{d\theta}(H_\theta(\nabla f^\perp(x, y)))|_{\theta=0} = -\nabla f(x, y)$$

Moreover, the expression

$$DX_\theta(x, y) = H_\theta \circ DX_{H_\theta^{-1}(x, y)} \circ H_\theta^{-1}$$

can be rewritten, for all $(x, y) \in \mathfrak{R}^2$, as

$$(4) \quad \begin{pmatrix} \nabla f_\theta(x, y) \\ \nabla g_\theta(x, y) \end{pmatrix} = H_\theta \cdot \begin{pmatrix} \nabla f(H_\theta^{-1}(x, y)) \\ \nabla g(H_\theta^{-1}(x, y)) \end{pmatrix} \cdot H_\theta^{-1}$$

Which implies that, for all $(x, y) \in \mathfrak{R}^2$,

$$\begin{pmatrix} \nabla f_\theta(H_\theta(x, y)) \\ \nabla g_\theta(H_\theta(x, y)) \end{pmatrix} = H_\theta \cdot \begin{pmatrix} \nabla f((x, y)) \\ \nabla g((x, y)) \end{pmatrix} \cdot H_\theta^{-1}$$

and so (by (1)) that, for all $(x, y) \in \mathfrak{R}^2$,

$$\begin{pmatrix} \nabla f_\theta^\perp(H_\theta(x, y)) \\ \nabla g_\theta^\perp(H_\theta(x, y)) \end{pmatrix} = H_\theta \cdot \begin{pmatrix} \nabla f(x, y) \\ \nabla g(x, y) \end{pmatrix} \cdot H_\theta^{-1} \cdot \begin{pmatrix} 0 & 1 \\ -1 & 0 \end{pmatrix}$$

Hence, by (2),

$$\begin{aligned} &\frac{d}{d\theta} \cdot \begin{pmatrix} \nabla f_\theta^\perp(H_\theta(x, y)) \\ \nabla g_\theta^\perp(H_\theta(x, y)) \end{pmatrix} |_{\theta=0} \\ &= \begin{pmatrix} 0 & -1 \\ 1 & 0 \end{pmatrix} \begin{pmatrix} \nabla f(x, y) \\ \nabla g(x, y) \end{pmatrix} \begin{pmatrix} 1 & 0 \\ 0 & 1 \end{pmatrix} \begin{pmatrix} 0 & 1 \\ -1 & 0 \end{pmatrix} \\ &\quad + \begin{pmatrix} 1 & 0 \\ 0 & 1 \end{pmatrix} \begin{pmatrix} \nabla f(x, y) \\ \nabla g(x, y) \end{pmatrix} \begin{pmatrix} 0 & 1 \\ -1 & 0 \end{pmatrix} \begin{pmatrix} 0 & 1 \\ -1 & 0 \end{pmatrix} \\ &= \begin{pmatrix} 0 & -1 \\ 1 & 0 \end{pmatrix} \begin{pmatrix} \nabla f^\perp(x, y) \\ \nabla g^\perp(x, y) \end{pmatrix} + \begin{pmatrix} \nabla f^\perp(x, y) \\ \nabla g^\perp(x, y) \end{pmatrix} \begin{pmatrix} 0 & 1 \\ -1 & 0 \end{pmatrix} \\ &= \begin{pmatrix} -\nabla g^\perp(x, y) \\ \nabla f^\perp(x, y) \end{pmatrix} + \begin{pmatrix} -\nabla f(x, y) \\ -\nabla g(x, y) \end{pmatrix} \\ &= \begin{pmatrix} -\nabla g^\perp(x, y) - \nabla f(x, y) \\ \nabla f^\perp(x, y) - \nabla g(x, y) \end{pmatrix} \end{aligned}$$

That is,

$$(5) \quad \frac{d}{d\theta} (\nabla f_{\theta}^{\perp}(H_{\theta}(x, y)))|_{\theta=0} = -\nabla g^{\perp}(x, y) - \nabla f(x, y)$$

Therefore, using (3),

$$\begin{aligned} & \frac{d}{d\theta} (\det(H_{\theta}(\nabla f^{\perp}(x, y)), \nabla f_{\theta}^{\perp}(H_{\theta}(x, y))))|_{\theta=0} \\ &= \det(\nabla f^{\perp}(x, y), -\nabla f(x, y) - \nabla g^{\perp}(x, y)) \\ & \quad + \det(-\nabla f(x, y), \nabla f^{\perp}(x, y)) \\ &= \det(\nabla f^{\perp}(x, y), -\nabla f(x, y) - \nabla g^{\perp}(x, y)) \\ & \quad + \det(\nabla f^{\perp}(x, y), \nabla f(x, y)) \\ &= \det(\nabla f^{\perp}(x, y), -\nabla g^{\perp}(x, y)) \\ &= -\det \left[\begin{pmatrix} \nabla f^{\perp}(x, y) \\ \nabla g^{\perp}(x, y) \end{pmatrix} \begin{pmatrix} 0 & 1 \\ -1 & 0 \end{pmatrix} \right] \\ &= -\det \begin{pmatrix} \nabla f(x, y) \\ \nabla g(x, y) \end{pmatrix} = -\det(DX(x, y)) < 0. \end{aligned}$$

The proof of (a) of this lemma is finished. Now we shall prove (b). Let $p \in \mathfrak{R}^2$ and $\theta \in (0, \pi)$ fixed but arbitrary. Let $\lambda : \mathfrak{R} \rightarrow F_p$ be a regular global parametrization of F_p . By assumption, for all $t \in \mathfrak{R}$, $f(\lambda(t)) \equiv f(p)$; i.e.,

(6) For all $t \in \mathfrak{R}$, the first coordinate of $DX(\lambda(t)) \cdot (\lambda'(t))$, namely $df(\lambda(t)) \cdot (\lambda'(t))$, is zero.

Therefore as, for all $q \in \mathfrak{R}^2$, $DX(q)$ is invertible,

(7) For all $t \in \mathfrak{R}^2$, $dg(\lambda(t)) \cdot (\lambda'(t))$, is different from zero

It is easy to see that

$$f_{\theta}(H_{\theta}(\lambda(t))) = \cos(\theta) \cdot f(\lambda(t)) - \sin(\theta) \cdot g(\lambda(t)).$$

Item (b) of this lemma follows easily from this expression, (6) and (7) above. \square

LEMMA 2.3. – Let C be a simple closed continuous curve made up of an arc of trajectory $[p, q]_f$ of ∇f^{\perp} and a smooth segment $[p, q]$ which meet to each other transversally and exactly at $\{p, q\}$. Let $\pi_1 : \mathfrak{R}^2 \rightarrow \mathfrak{R}$ be given by $\pi_1(x, y) = x$. Suppose that C is contained in the complement of the compact ball of radius $\rho+1$ centered at the origin. If ∇f points inward (resp. outward) the disc bounded by C , along $(p, q)_f$, then $\inf(\pi_1([p, q]_f)) = x_2 \geq x_1 = \inf(\pi_1([p, q]))$ (resp. $\sup(\pi_1([p, q]_f)) = \tilde{x}_2 \leq \tilde{x}_1 = \sup(\pi_1([p, q]))$).

Consider only the case in which ∇f points inward C along $(p, q)_f$. Assume by contradiction that $\inf(\pi_1([p, q]_f)) = x_2 < x_1$ and take a point $(x_2, y_2) \in [p, q]_f$. See fig. 2.3. By the assumptions, there exists a vector field $Y : C \rightarrow \mathfrak{R}^2$ which points inward the disc bounded by C and which coincides with ∇f in the complement of a small neighbourhood V of $[p, q]$. We may take V so small that $(x_2, y_2) \notin V$. As the half plane $\{(x, y) \in \mathfrak{R}^2 : x < x_2\}$ is disjoint of C and ∇f points inward C at (x_2, y_2) we must have that $\nabla f(x_2, y_2) \in (0, \infty) \times \{0\}$. However this is a contradiction with the ρ -obstruction property. \square

Let $S^1 = \{z \in \mathbf{C} : |z| = 1\}$, we shall denote by $cl(\mathfrak{R}^2)$ the compact space made up of the (disjoint) union of \mathfrak{R}^2 and S^1 and constructed in the following way: Let $\varphi : [0, 1) \rightarrow [0, \infty)$ be a smooth diffeomorphism which is the identity in a small neighbourhood of 0. Let $G : \{z \in \mathbf{C} : |z| < 1\} \rightarrow \mathfrak{R}^2$ be the diffeomorphism given by $G(x + iy) = \varphi(x^2 + y^2) \cdot (x, y)$. By identifying $(x + iy)$ with $G(x + iy)$ and by borrowing from $\{z \in \mathbf{C} : |z| \leq 1\}$ its topology, we shall obtain the required topology for $cl(\mathfrak{R}^2)$. Given a half trajectory F_p^δ of ∇f^\perp , it follows from the Poincare-Bendixon Theorem and from the fact that ∇f^\perp has no singularities that the limit set $\mathcal{L}(F_p^\delta)$ of F_p^δ , as a subset of $cl(\mathfrak{R}^2)$, is either S^1 or a nonempty closed subinterval of it. Proper subintervals of S^1 will be denoted in the following way: given two real numbers $\theta_1 \leq \theta_2$ such that $\theta_2 - \theta_1 < 2\pi$,

$$[e^{i\theta_1}, e^{i\theta_2}] = \{e^{i\theta} : \theta_1 \leq \theta \leq \theta_2\}$$

$$(e^{i\theta_1}, e^{i\theta_2}) = \{e^{i\theta} : \theta_1 < \theta < \theta_2\}$$

etc.

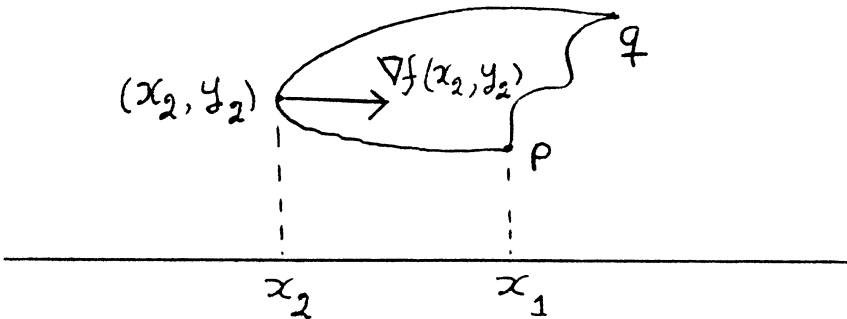

FIG. 2.3

LEMMA 2.4. – Let $\pi_1 : \mathfrak{R}^2 \rightarrow \mathfrak{R}$ be given by $\pi_1((x, y)) = x$. Suppose that $F_{p_1}^+, F_{p_3}^-$ and $[p_1, p_3]$ are the edges of a half-Reeb component C . Suppose

that C is contained in the complement of the compact ball of radius $\rho + 1$ centered at the origin. If ∇f points inward C (resp. outward C) along $F_{p_1}^+ \cup F_{p_3}^-$, then

(a) $C \subset \{(x, y) \in \mathfrak{R}^2 : x \geq x_1 = \inf(\pi_1([p_1, p_3]))\}$

(resp. $C \subset \{(x, y) \in \mathfrak{R}^2 : x \leq x_2 = \sup(\pi_1([p_1, p_3]))\}$). In particular

(b) $[\theta_1^-, \theta_1^+] \cup [\theta_3^-, \theta_3^+] \subset [-\pi/2, \pi/2]$

(resp. $[\theta_1^-, \theta_1^+] \cup [\theta_3^-, \theta_3^+] \subset [\pi/2, 3\pi/2]$) where

$$\mathcal{L}(F_{p_1}^+) = [e^{i\theta_1^-}, e^{i\theta_1^+}] \quad \text{and} \quad \mathcal{L}(F_{p_3}^-) = [e^{i\theta_3^-}, e^{i\theta_3^+}].$$

Moreover,

(c) $\theta_1^+ \geq \theta_3^+ \quad \text{and} \quad \theta_1^- \geq \theta_3^-$

(resp. $\theta_1^+ \leq \theta_3^+$ and $\theta_1^- \leq \theta_3^-$).

Proof. – Consider only the case in which ∇f points inward C along $F_{p_1}^+ \cup F_{p_3}^- \setminus \{p_1, p_3\}$. Let $\gamma : [1, 3] \rightarrow [p_1, p_3]$ be a smooth parametrization such that $\gamma(s) = p_s$, for $s \in \{1, 3\}$.

Let $\pi_1 : \mathfrak{R}^2 \rightarrow \mathfrak{R}$ be the projection $(x, y) \rightarrow x$. If $1 < s < t < 3$ are such that $\gamma(s)$ and $\gamma(t)$ are the endpoints of an arc of trajectory of ∇f^\perp that is contained in C , we may apply Lemma 2.3 to the simple closed curve $[\gamma(s), \gamma(t)]_f \cup \gamma([s, t])$ to conclude that $\inf(\pi_1([\gamma(s), \gamma(t)]_f)) \geq \inf(\pi_1(\gamma([s, t])))$. It follows from this that (a) and (b) of this lemma are true.

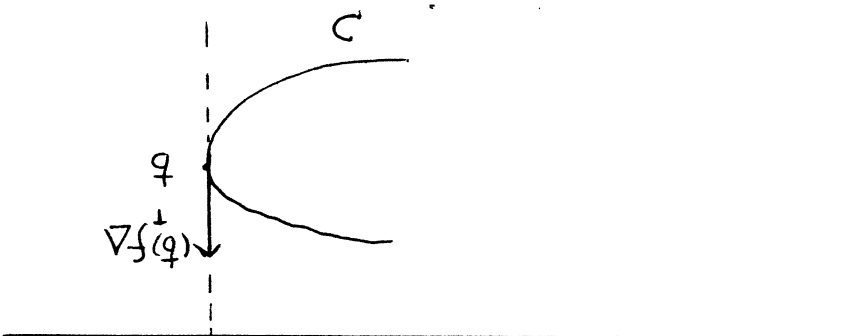

FIG. 2.4

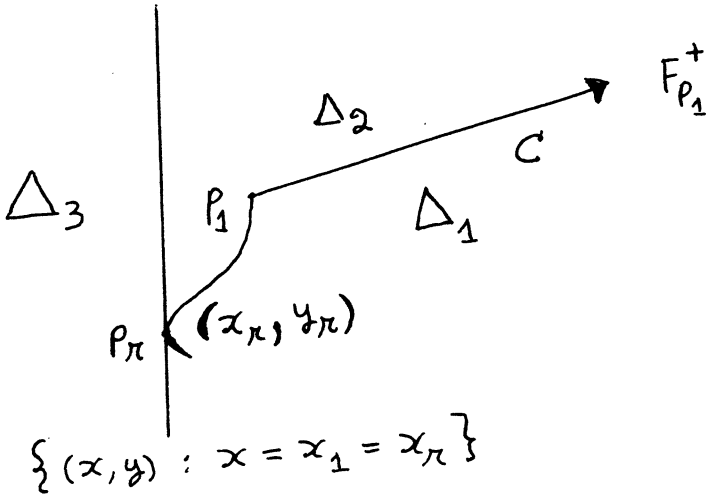

FIG. 2.5

(1) $F_{p_1}^+$ may meet $\{(x, y) : x = x_1\}$ at most at p_1 .

Otherwise, if $q = (x_1, y_1) \in F_{p_1}^+ \setminus \{p_1\}$, then, by (a) and (b) of this lemma, $\nabla f^\perp(q)$ would be tangent to $\{(x, y) : x = x_1\}$. By the ρ -obstruction property, $\nabla f^\perp(q) \in \{0\} \times (-\infty, 0)$. As C is on the right of $F_{p_1}^+$, there would be points of C in the half plane $\{(x, y) : x < x_2\}$. See fig. 2.4. This contradiction with (a) and (b) proves (1).

Let $\gamma(r) = p_r = (x_r, y_r)$. By what was said above, the union of the curves $\{x = x_r\}$ and $[p_1, p_r]_\gamma \cup F_{p_1}^+$ separate their complement in \mathbb{R}^2 into three open connected components $\Delta_1, \Delta_2, \Delta_3$ where

$$\begin{aligned} \partial\Delta_1 &= \{x = x_r, y \leq y_r\} \cup [p_1, p_r]_\gamma \cup F_{p_1}^+, \\ \partial\Delta_2 &= \{x = x_r, y \geq y_r\} \cup [p_1, p_r]_\gamma \cup F_{p_1}^+, \\ \partial\Delta_3 &= \{x = x_r\}. \end{aligned}$$

As C is on the right of $F_{p_1}^+$, $C \subset \Delta_1 \cup \partial\Delta_1$. See fig. 2.5. Therefore, (c) is true. \square

LEMMA 2.5. – Let $\gamma : [0, 4] \rightarrow \mathbb{R}^2$ be a smooth curve such that $(f \circ \gamma)'(s)$ vanishes exactly at $s = 2$ and $(f \circ \gamma)''(2) = c \neq 0$. If $\gamma([1, 3])$ is the compact edge of a half-Reeb component C of ∇f^\perp then, for some $\varepsilon > 0$, there are continuous monotone functions

$$L, R, \tau : (-\varepsilon, \varepsilon) \rightarrow [0, 4]$$

such that $L(0) = 1, \tau(0) = 2, R(0) = 3$ and

- (a) $\frac{d}{ds}(f_\theta \circ H_\theta \circ \gamma(s))$ vanishes exactly at $s = \tau(\theta)$ and, for all $\theta \in (-\varepsilon, \varepsilon)$,
 $\left| \frac{d^2}{ds^2}(f_\theta \circ H_\theta \circ \gamma(\tau(\theta))) - \frac{c}{2} \right| \neq 0$;
- (b) $H_\theta \circ \gamma([L(\theta), R(\theta)])$ is the compact edge of a half-Reeb component $C(\theta)$ of ∇f^\perp ;
- (c) The following possible properties do not depend on θ :
- (c.1) $C(\theta)$ is on the left of $H_\theta \circ \gamma$
- (c.2) $C(\theta)$ is on the right of $H_\theta \circ \gamma$
- (c.3) ∇f_θ points into $C(\theta)$ (along its non-compact edges)
- (c.4) ∇f_θ points out of $C(\theta)$ (along its non-compact edges);
- (d) If $C(\theta)$ is on the left (resp. on the right) of $H_\theta \circ \gamma$ then $L(\theta), \tau(\theta), R(\theta)$ are strictly decreasing (resp. strictly increasing) functions;
- (e) If F_r^+ and $F_{\tilde{r}}^-$, with $r, \tilde{r} \in \{p_1, p_3\}$, are the positive and negative trajectories which are the edges of C , then $\{e^{i\frac{\pi}{2}}, e^{i\frac{3\pi}{2}}\}$ is disjoint of $\mathcal{L}(F_r^+) \cup \mathcal{L}(F_{\tilde{r}}^-)$.

Proof. – As

$$\begin{pmatrix} f_\theta \\ g_\theta \end{pmatrix} = X_\theta = H_\theta \circ X \circ H_\theta^{-1},$$

we have that

$$(1) \quad f_\theta(H_\theta(\gamma(s))) = \cos \theta \cdot (f \circ \gamma)(s) - \sin \theta \cdot (g \circ \gamma)(s), \text{ and}$$

$$DX_\theta(H_\theta(\gamma(s))) = H_\theta \circ DX(\gamma(s)) \circ H_\theta^{-1}.$$

Hence,

$$\begin{aligned} \frac{d}{ds} \begin{pmatrix} f_\theta(H_\theta(\gamma(s))) \\ g_\theta(H_\theta(\gamma(s))) \end{pmatrix} &= \frac{d}{ds}(X_\theta \circ H_\theta(\gamma(s))) \\ &= DX_\theta(H_\theta(\gamma(s))) \cdot \frac{d}{ds}(H_\theta \circ \gamma(s)) \\ &= H_\theta \circ DX(\gamma(s)) \cdot \gamma'(s) \\ &= H_\theta \left(\frac{d}{ds}(X \circ \gamma(s)) \right) \\ &= H_\theta \begin{pmatrix} (f \circ \gamma)'(s) \\ (g \circ \gamma)'(s) \end{pmatrix} \\ &= \begin{pmatrix} \cos \theta \cdot (f \circ \gamma)'(s) - \sin \theta \cdot (g \circ \gamma)'(s) \\ \sin \theta \cdot (f \circ \gamma)'(s) + \cos \theta \cdot (g \circ \gamma)'(s) \end{pmatrix} \end{aligned}$$

Thus,

$$(2) \quad \Delta(\theta, s) = \frac{d}{ds}(f_\theta(H_\theta(\gamma(s))))$$

$$= \cos \theta \cdot (f \circ \gamma)'(s) - \sin \theta \cdot (g \circ \gamma)'(s)$$

As $\Delta(0, 2) = 0$ and $\frac{\partial}{\partial s}\Delta(0, 2) = (f \circ \gamma)''(2)$, it follows, from the Implicit Function Theorem, that there exists a C^1 function

$$\tau : (-\varepsilon, \varepsilon) \rightarrow [0, 4]$$

such that $\Delta(\theta, \tau(\theta)) \equiv 0$. It follows that

$$\frac{\partial \Delta}{\partial \theta}(0, 2) + \frac{\partial \Delta}{\partial s}(0, 2) \cdot \tau'(0) = -(g \circ \gamma)'(2) + (f \circ \gamma)''(2) \cdot \tau'(0) = 0$$

and so,

$$(3) \quad \tau'(0) = \frac{(g \circ \gamma)'(2)}{(f \circ \gamma)''(2)}.$$

Now we claim that

(4) If C is on the left of γ , then $\tau'(0) < 0$.

In fact, suppose first that ∇f points inward C . The assumptions imply that $(f \circ \gamma)$ has a maximum at $s = 2$ and so $(f \circ \gamma)''(2) < 0$. Also as both $\{\nabla f(\gamma(2)), \gamma'(2)\}$ and $\{\nabla f(\gamma(2)), \nabla g(\gamma(2))\}$ are positive basis, it must be that $(g \circ \gamma)'(2) > 0$. Hence $\tau'(0) < 0$.

Suppose this time that ∇f points outward C . Similarly as above we may see that $(f \circ \gamma)''(2) > 0$ and $(g \circ \gamma)'(2) < 0$ and so $\tau'(0) < 0$. This proves (4). See fig. 2.6.

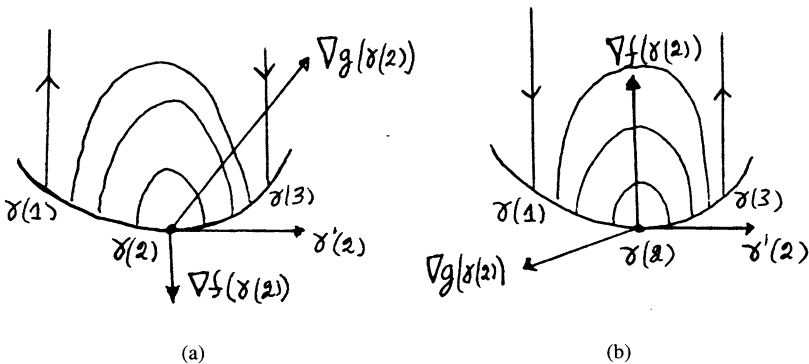

FIG. 2.6

Proceeding in this way, we may obtain that (a) is true and that if C in on the left (resp. on the right) of γ then $\tau = \tau(\theta)$ is a strictly decreasing (resp. increasing) function of θ .

To prove (b), consider only the case in which

(5) C is on the left of γ and ∇f points inward C .

Let $0 < \delta < 1$ be given. By the assumptions of the lemma, $f \circ \gamma(1 - \delta) \notin f \circ \gamma([1, 3])$. Therefore, there exists $\varepsilon > 0$ such that

(6) For all $\theta \in [-\varepsilon, \varepsilon]$, $f_\theta(H_\theta \circ \gamma(1 - \delta)) \notin f_\theta(H_\theta \circ \gamma([1, 3]))$.

As ∇f_θ^\perp depends differentiably on θ and by the behaviour of the trajectories of ∇f in C , we may see that if $\varepsilon > 0$ is small enough, for each $\theta \in (-\varepsilon, \varepsilon)$, there exists an orientation reversing continuous map

$$T_\theta : (L(\theta), \tau(\theta)] \rightarrow [\tau(\theta), 4]$$

such that

(7) $T_\theta(\tau(\theta)) = \tau(\theta)$ and, for all $s \in (L(\theta), \tau(\theta)]$, there is an arc of trajectory M_s^θ of ∇f_θ^\perp starting at $H_\theta(\gamma(s))$ and ending at $H_\theta(\gamma(T_\theta(s)))$.

As f_θ is constant along each arc M_s^θ of ∇f_θ^\perp , it follows from (6) that $1 - \delta \leq L(\theta)$. It follows from Lemma 2.2 that if $\theta \in (0, \varepsilon)$, we may take $L(\theta) < 1$ and so $R(\theta) = \lim_{s \rightarrow L(\theta)} T_\theta(s) < 3$. Therefore if $L(\theta)$ is determined

by the fact that $(L(\theta), \tau(\theta)]$ is the maximal interval where T_θ can be defined so to satisfy (b), we will have that:

(8) if $\theta \in (0, \varepsilon)$, $1 - \delta \leq L(\theta) < 1$.

Similarly, using Lemma 2.2, we may prove that

(9) If $\varepsilon > 0$ is small enough and $\theta \in (-\varepsilon, 0)$, then $1 < L(\theta) < 1 + \delta$.

This proves that $\theta \rightarrow L(\theta)$ is continuous and strictly decreasing. Similarly, we may conclude that

(10) $R(\theta)$ is continuous and strictly decreasing.

Under these circumstances, (b), (c) and (d) are immediate.

Let $B(0; \rho + 1)$ be the compact ball of radius $\rho + 1$ centered at the origin. To prove (e), observe first that C contains a half-Reeb component $\tilde{C} \subset \mathfrak{R}^2 \setminus B(0; \rho + 1)$ such that the edges of \tilde{C} , which are half-trajectories, are contained in $F_r^+ \cup F_r^-$. As the conclusions in (e) refer only to the asymptotic limit sets $\mathcal{L}(F_r^+)$ and $\mathcal{L}(F_r^-)$, we may suppose in the remainder of the proof that C itself is disjoint of $B(0; \rho + 1)$.

To proceed with the proof of (e), consider only the case in which ∇f points inward C along $\partial_1 C \setminus [p_1, p_3]_\gamma$ and C is on the left of γ . This implies that

(11) $p_r = p_1$.

As the required conclusion in (e) is related to $F_{p_1}^+$ and $F_{p_3}^-$, it can be assumed, by means of a small perturbation of γ , that when $\varepsilon > 0$ is small and $\theta \in [0, \varepsilon]$,

(12) Both ∇f_θ^\perp and the vertical foliation (i.e. the one made up of the lines $\{(x, y) : x = \text{constant}\}$) meet transversally $H_\theta \circ \gamma$ at the

points $H_\theta \circ \gamma(0)$ and $H_\theta \circ \gamma(4)$. Moreover, there is exactly one point $m_\theta = (x_\theta, y_\theta) \in H_\theta \circ \gamma([0, 4])$, depending differentiably on θ , such that $x_\theta = \inf(\pi_1(H_\theta \circ \gamma([0, 4])))$ and if $m_\theta \notin \{H_\theta \circ \gamma(0), H_\theta \circ \gamma(4)\}$ then $H_\theta \circ \gamma$ has quadratic contact with $\{(x, y) : x = x_\theta\}$ at (x_θ, y_θ) .

Now,

(13) Fix $\theta \in (0, \varepsilon)$.

Assume, by contradiction, that

(14) $e^{i\pi/2} \in \mathcal{L}(F_{p_1}^+)$.

We claim that if $\varepsilon > 0$ is small enough.

(15) $H_\theta(F_{p_1}^+)$ crosses $\{(x, y) : x = x_\theta\}$ at a point $n_\theta = (x_\theta, z_\theta)$ with $z_\theta > y_\theta$. See fig. 2.7.

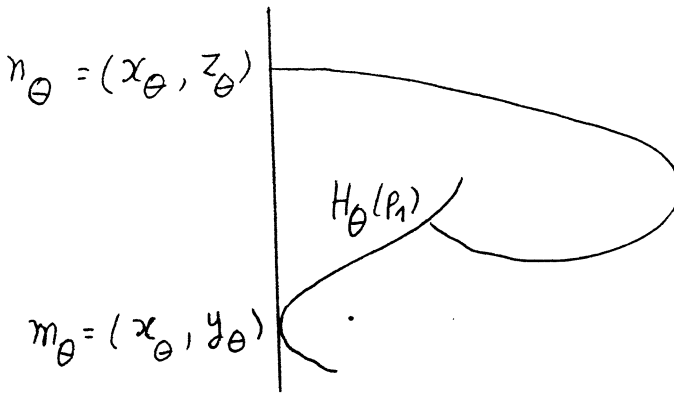

FIG. 2.7

In fact, first observe that if $p_1 = m_0 = (x_0, y_0)$, then, by the ρ -obstruction property, $\nabla f^\perp(p_1)$ has positive first coordinate and therefore, if $\varepsilon > 0$ is small and so (x_θ, y_θ) is very close to $H_\theta(x_0, y_0)$, $H_\theta(F_{p_1}^+ \setminus \{p_1\})$ cannot meet the subsegment of $H_\theta \circ \gamma$ with endpoints $H_\theta(x_0, y_0)$ and $(x_\theta, y_\theta) = m_\theta$. If $p_1 \neq m_0$, then $\varepsilon > 0$ can be taken so small that $(x_\theta, y_\theta), (x_0, y_0)$ and $H_\theta((x_0, y_0))$ are so close to each other that $H_\theta(F_{p_1}^+)$ cannot meet the subsegment of $H_\theta \circ \gamma$ with endpoints $H_\theta(x_0, y_0)$ and m_θ . (See fig. 2.8). As by Lemma 2.4 and (12), $H_\theta(F_{p_1}^+) \subset H_\theta(\{(x, y) : x \geq x_0\})$ we must have that $H_\theta(F_{p_1}^+)$ does not meet $\{(x, y) : x = x_\theta \text{ and } y \leq y_\theta\}$. Therefore, as by (14),

$$e^{i(\frac{\pi}{2} + \theta)} \in \mathcal{L}(H_\theta(F_{p_1}^+)),$$

it must be that (15) is true.

Let consider the disc D bounded by the straight line segment $[m_\theta, n_\theta]$, the subarc $[H_\theta(p_1), n_\theta]$ of $H_\theta(F_{p_1}^+)$ and the subsegment $[H_\theta(p_1), m_\theta]_{H_\theta \circ \gamma}$

of $H_\theta \circ \gamma$. If $[H_\theta(p_1), n_\theta]$ is provided with the orientation induced by that of $H_\theta(F_{p_1}^+)$, then as $[m_\theta, n_\theta]$ is on the left,
 (16) D is on the left of $[H_\theta(p_1), n_\theta]$.

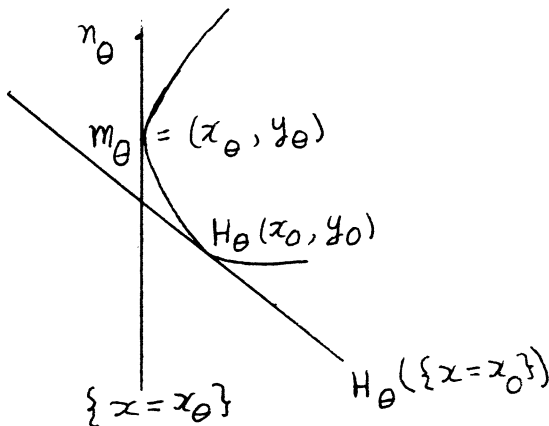

FIG. 2.8

It follows from the Lemma 2.2 that the oriented arcs M_s^θ , introduced in (7), meet $[H_\theta(p_1), n_\theta]$ exactly once and transversally and, when they do this, it is from the left of $[H_\theta(p_1), n_\theta]$. Let K_s^θ be the subarc of M_s^θ starting at $H_\theta(\gamma(s))$ and ending at $M_s^\theta \cap [H_\theta(p_1), n_\theta]$. Under these circumstances, it follows from (16) that, for $s < 1$ close to 1, $K_s^\theta \subset D$. We claim that

$$(17) \quad s^* := \inf\{s : K_s^\theta \subset D\} = L(\theta)$$

Assume, by contradiction, that $L(\theta) < s^*$. Then $K_{s^*}^\theta$ is disjoint of $[m_\theta, n_\theta]$, because otherwise any arc K_s^θ , with $s < s^*$ close to s^* , would meet $\{(x, y) : x < x_\theta\}$ contradicting Lemma 2.3. Also $K_{s^*}^\theta$ is disjoint of $[H_\theta(p_1), m_\theta]_{H_\theta \circ \gamma}$, because otherwise $K_{s^*}^\theta \cap [H_\theta(p_1), m_\theta] = \gamma(\tau(\theta))$. However, by (a), $f_\theta(\gamma(\tau(\theta))) \neq f_\theta(K_{s^*}^\theta)$. This implies (17).

It follows from the trajectory structure of $\nabla f^\perp|_C$ and Lemma 2.2 that the arc of trajectory of ∇f_θ^\perp starting at a point of $[H_\theta(p_1), n_\theta]$ must reach $H_\theta \circ \gamma$. This and (17) imply that there is an arc $M_{L(\theta)}^\theta$ of ∇f_θ^\perp which contradicts the assumed properties of $L(\theta)$. Therefore (e) is proved. \square

LEMMA 2.6. – Let $\gamma : [0, 3] \rightarrow \mathfrak{R}^2$ be a smooth curve such that γ restricted to $[0, 1]$ is transversal to ∇f^\perp and $\gamma([1, 3])$ is the compact edge of the half-Reeb component C .

(a) If C is on the left (resp. on the right) of γ and its noncompact edges are $F_{\gamma(1)}^+$ and $F_{\gamma(3)}^-$ then

$$\mathcal{L}(F_{\gamma(0)}^+) \subset (e^{-i\pi/2}, e^{i\pi/2}]$$

(resp. $\mathcal{L}(F_{\gamma(0)}^+) \subset [e^{i\pi/2}, e^{3i\pi/2}]$).

(b) If C is on the left (resp. on the right) of γ and its noncompact edges are $F_{\gamma(1)}^-$ and $F_{\gamma(3)}^+$ then

$$\mathcal{L}(F_{\gamma(0)}^-) \subset (e^{i\pi/2}, e^{3i\pi/2}]$$

(resp. $\mathcal{L}(F_{\gamma(0)}^-) \subset [e^{-i\pi/2}, e^{i\pi/2})$).

See fig. 2.9.

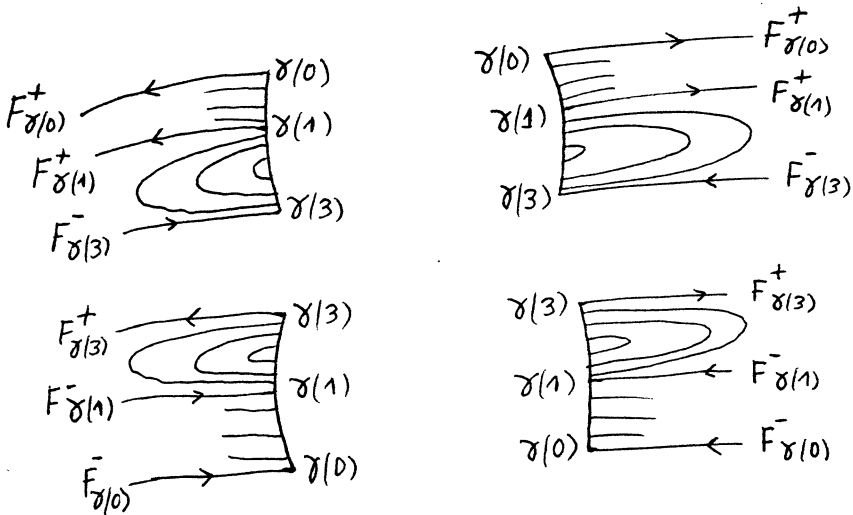

FIG. 2.9

Proof. – Consider only the case in which $F_{\gamma(1)}^+$ is an edge of C and that C is on the left of γ .

In the following, $B(0; \tilde{\rho})$ will denote the compact ball of radius $\tilde{\rho}$ centered at the origin. As the conclusions in (e) refer only to the asymptotic limit sets $\mathcal{L}(F_r^+)$, $\mathcal{L}(F_{\tilde{r}}^-)$ and $\mathcal{L}(F_{\gamma(0)}^+)$, by the same arguments used in the proof of Lemma 2.5 (e), we may suppose that $C \cup F_{\gamma(0)}^+$ is disjoint of $B(0; \rho + 3)$. Notice that $\gamma([0, 1])$ may or may not meet $B(0; \rho)$.

Let (x_0, y_0) be the point of $\gamma([0, 3])$ such that $x_0 = \inf(\pi_1(\gamma([0, 3])))$ and $\{(x, y) : y > y_0\}$ is disjoint of $\gamma([0, 3])$. Here $\pi_1 : \mathfrak{R}^2 \rightarrow \mathfrak{R}$ is the projection on the first coordinate.

Suppose by contradiction that

(1) $\mathcal{L}(F_{\gamma(0)}^+)$ is not contained in $(e^{-i\pi/2}, e^{i\pi/2}]$.

By the same argument as that of the proof of (c) of Lemma 2.4, $F_{\gamma(0)}^+$ must cross transversally $\{x = x_0\}$ at some point (x_0, z_0) with $z_0 > y_0$. This implies that there exists $p \in F_{\gamma(0)}^+$ close to (x_0, z_0) such that

(2) $x_0 = \inf(\pi_1(\gamma([0, 3]))) > \pi_1(p)$, $\nabla f^\perp(p)$ has negative first coordinate and for some $\varepsilon > 0$ and for all $z \in [\pi_1(p) - \varepsilon, \pi_1(p) + \varepsilon]$, the arc of trajectory $[\gamma(0), p]_f$ of ∇f^\perp meets $\{(x, y) : x = z\}$ exactly once and transversally at a point belonging to $\mathfrak{R} \setminus B(0; \rho + 2)$. See fig. 2.10.

As, by Lemmas 2.3, 2.4 and 2.5 (e), $\mathcal{L}(F_{\gamma(1)}^+) \subset (e^{-i\pi/2}, e^{i\pi/2})$ and $F_{\gamma(1)}^+ \subset \{(x, y) : x \geq x_0\}$, using an argument similar to that of (2) above, there exists $q \in F_{\gamma(1)}^+$ such that

(3) $\sup(\pi_1(\gamma([0, 3]))) < \pi_1(q)$, $\nabla f^\perp(q)$ has positive first coordinate and for some $\varepsilon > 0$ and for all $z \in [\pi_1(q) - \varepsilon, \pi_1(q) + \varepsilon]$, the arc of trajectory $[\gamma(0), p]_f$ of ∇f^\perp meets $\{(x, y) : x = z\}$ exactly once and transversally at a point belonging to $\mathfrak{R} \setminus B(0; \rho + 2)$. See fig. 2.10.

The piecewise differentiable curve $[\gamma(0), p]_f \cup [\gamma(0), \gamma(1)]_\gamma \cup [\gamma(1), q]_f$ can be approximated by a smooth embedding $\lambda : [0, 3] \rightarrow [\pi_1(p), \pi_1(q)] \times \mathfrak{R}$, transversal to ∇f^\perp connecting $p = \lambda(0)$ with $q = \lambda(3)$, and in such a way that ∇f^\perp points to the left of λ (i.e., for all $s \in [0, 3]$, $\{\lambda'(s), \nabla f(\lambda(s))\}$ is a negative basis) and for all $z \in [\pi_1(p), \pi_1(p) + \varepsilon] \cup [\pi_1(q) - \varepsilon, \pi_1(q)]$ (with $\varepsilon > 0$ as in (2) and (3) above), λ meets $\{(x, y) : x = z\}$ exactly once and transversally. The curve λ is represented in figure 2.10 by a dotted line.

The curve $\nabla f^\perp \circ \lambda : [0, 3] \rightarrow \mathfrak{R}^2 \setminus \{0\}$ connects the point $\nabla f^\perp(p)$ (having negative first coordinate) with the point $\nabla f^\perp(q)$ (having positive first coordinate).

It is not difficult to see that there is a smooth diffeotopy $t \rightarrow G_t$, $t \in [0, 1]$, of \mathfrak{R}^2 , such that

(4) G_0 is the identity map. For all $t \in [0, 1]$, G_t restricted to the complement of $(\pi_1(p) + \varepsilon, \pi_1(q) - \varepsilon) \times \mathfrak{R}$ in \mathfrak{R}^2 is the identity map. The image of $G_1 \circ \lambda$ is the graph of a function $[\pi_1(p), \pi_1(q)] \rightarrow \mathfrak{R}$.

This implies that if $Y(t) = (DG_1)_{\lambda(t)} \cdot \nabla f^\perp(\lambda(t))$, then $Y(t)$ points to the left of $G_1 \circ \lambda$ and, by (4), it does not meet the ray $\{(0, y) : y < 0\}$.

There exists a neighborhood $V(p, q)$ of $\{p, q\}$ such that λ is homotopic, with $V(p, q)$ held fixed, to a smooth embedding

$$\mu : [0, 3] \rightarrow ([\pi_1(p), \pi_1(q)] \times \mathfrak{R}) \setminus B(0; \rho + 1),$$

in such a way that, for all $z \in [\pi_1(p), \pi_1(p) + \varepsilon] \cup [\pi_1(q) - \varepsilon, \pi_1(q)]$ (with $\varepsilon > 0$ as in (2) and (3) above), μ meets $\{(x, y) : x = z\}$ exactly once and transversally. See the curve μ in figure 2.10.

The curve $\nabla f^\perp \circ \mu : [0, 3] \rightarrow \mathfrak{R}^2 \setminus \{0\}$ connects the point $\nabla f^\perp(p)$ (having negative first coordinate) with the point $\nabla f^\perp(q)$ (having positive

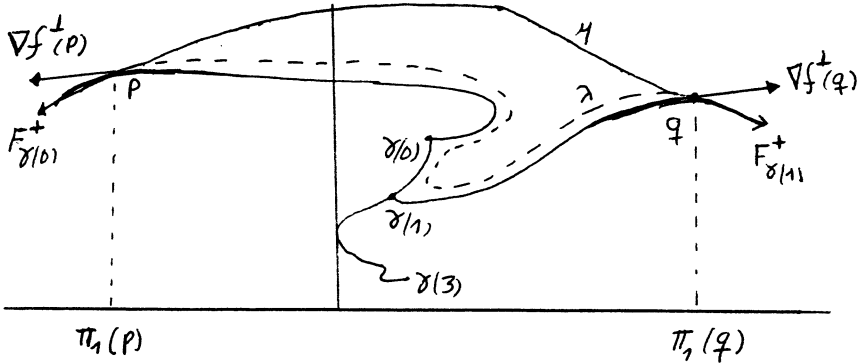

FIG. 2.10

first coordinate), and, by the ρ -obstruction property, the image of $\nabla f^\perp \circ \mu$ does not meet the ray $\{(0, y) : y > 0\}$. However this is a contradiction because the paths Y and $\nabla f^\perp \circ \mu$ cannot be homotopic in $\mathfrak{R}^2 \setminus \{0\}$. \square

Proof of Proposition 2.1. – If we assume that this proposition is false, we shall immediately reach a contradiction with lemmas 2.4, 2.5 (e) and 2.6. \square

3. A CANONICAL DECOMPOSITION

Let $a, p, q \in \mathfrak{R}^2$ be such that F_a, F_p and F_q are three different trajectories of ∇f^\perp . We say that F_a is *between* F_p and F_q if the last two are contained in different connected components of $\mathfrak{R}^2 \setminus \mathfrak{F}_a$. Let $[F_p, F_q]$ be the closure of the connected component of $\mathfrak{R}^2 \setminus (\mathfrak{F}_p \cup \mathfrak{F}_q)$ whose boundary is $F_p \cup F_q$. A *transversal region* of $[F_p, F_q]$ will be a connected component of the set formed by the union of $F_p \cup F_q$ with all the trajectories that are between F_p and F_q .

Observe that the function g is strictly monotone along any given trajectory F_p of ∇f^\perp . This follows immediately from the fact that if v is a vector tangent to F_p at some point a then, as $\nabla f(a) \cdot v = 0$ and $\det(DX(a)) > 0$, $\nabla g(a) \cdot v \neq 0$. In particular if p and q are singularities of X then F_p is disjoint of F_q .

PROPOSITION 3.1. – *Let $p, q \in \mathfrak{R}^2$ be such that $X(p) = X(q) = 0$. Among all smooth curves connecting p with q , the curve $\gamma : [0, 1] \rightarrow [F_p, F_q]$ with $\gamma(0) = p$ and $\gamma(1) = q$ has the least possible number of tangency points with ∇f^\perp if and only if there are numbers*

$$r_0 = 0 \leq l_1 < r_1 \leq l_2 < r_2 \leq \dots \leq l_n < r_n \leq 1 = l_{n+1},$$

with $n \geq 1$, satisfying (a) and (b) below:

(a) For all $i \in \{1, 2, \dots, n\}$, $\gamma([l_i, r_i])$ is the compact edge of a half-Reeb component C_i .

(b) Given $i \in \{0, 1, \dots, n\}$, the union T_i of all the trajectories $F_{\gamma(s)}$, with $s \in [r_i, l_{i+1}]$, is a transversal region of $[F_p, F_q]$. Also, for all $s \in [r_i, l_{i+1}]$,

$$F_{\gamma(s)} \cap \gamma([0, 1]) = \{\gamma(s)\}.$$

Furthermore,

(c) Let $\gamma, \gamma^* : [0, 1] \rightarrow [F_p, F_q]$ be smooth curves, connecting $\gamma(0) = \gamma^*(0) = p$ with $\gamma(1) = \gamma^*(1) = q$ and having the least possible number of tangency points with ∇f^\perp . Let C_i and T_i (resp. C_i^* and T_i^*) be the half-Reeb components and transversal regions, respectively, associated to $([F_p, F_q], \gamma)$ (resp. to $([F_p, F_q], \gamma^*)$) and indexed orderly as in (a) and (b) above. Then $T_i = T_i^*$ and the intersection of C_i and C_i^* contains a half-Reeb component whose non-compact edges are contained in the non-compact edges of both C_i and C_i^* .

The proof of Proposition 3.1 follows immediately from Lemmas 3.2-3.4.

LEMMA 3.2. – There exists a smooth curve $\gamma : [0, 1] \rightarrow [F_p, F_q]$ with $\gamma(0) = p$, $\gamma(1) = q$ and there are real numbers

$$0 < t_1 < t_2 < \dots < t_n < 1$$

such that:

(a) $(f \circ \gamma)'(s) = 0$ if and only if $s \in \{t_1, t_2, \dots, t_n\}$. Moreover, for all $s \in \{t_1, t_2, \dots, t_n\}$, $(f \circ \gamma)''(s) \neq 0$; and

(b) A trajectory of ∇f^\perp can meet γ at most at two points and, if so, it does it transversally.

Proof. – Let $\gamma : [0, 1] \rightarrow [F_p, F_q]$ be a smooth curve connecting $\gamma(0) = p$ with $\gamma(1) = q$. By a small perturbation (if necessary) we may assume that γ satisfies (a). As trajectories of ∇f^\perp can accumulate only at infinity, by a small perturbation of γ , we may assume that

(1) A trajectory may meet tangentially γ at most at one point.

We will proceed to reconstruct γ obtaining a new curve, still denoted by γ , but with less number of points of tangency with ∇f^\perp than the starting curve. To that end, consider first the following situation:

(2) There is a trajectory F_a of ∇f^\perp that meets γ transversally at a and tangentially at some point b , and $\gamma \cap [a, b]_f = [a, b]_\gamma \cap [a, b]_f = \{a, b\}$.

In this situation we choose a small flow box B centered at $[a, b]_f$, take two points $\tilde{a}, \tilde{b} \in B \cap \gamma$ such that $(\tilde{a}, \tilde{b})_\gamma$ contains properly $[a, b]$, and replace

the original $[a, b]_\gamma$ by a new segment (drawn as a dotted line in Figure 3.1) contained in B and transversal to ∇f^\perp . Observe that ∇f^\perp had at least two tangency points with the previous $[a, b]_\gamma$: one at b and the other at some point $c \in (a, b)_\gamma$. As $[F_p, F_q]$ is simply connected, the new curve constructed in this way is contained in $[F_p, F_q]$.

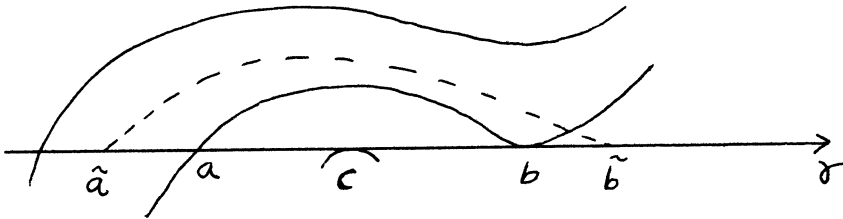

FIG. 3.1

By repeating when necessary the procedure above, we may assume that (3) Any trajectory of ∇f^\perp that meets γ more than once must do it transversally everywhere.

Under condition (3), we shall decrease the number of tangency points using one of the procedures indicated at the items (4)-(6) below.

(4) There are three consecutive points a_1, a_2 and a_3 of a positive half-trajectory of ∇f^\perp such that $\gamma \cap [a_1, a_3]_f = [a_1, a_3]_\gamma \cap [a_1, a_3]_f = \{a_1, a_2, a_3\}$.

In this situation we consider a small flow box B centered at $[a_1, a_3]_f$, take a point $a_4 \in B \cap \gamma$ such that $[a_1, a_4]_\gamma$ contains properly $[a_1, a_3]_\gamma$ and consider a segment transversal to ∇f^\perp contained in B and joining a_1 with a_4 . See fig. 3.2. Now, we put this new segment instead of the original $[a_1, a_4]_\gamma$. The resulting new segment (drawn with a dotted curve in figure 3.2) has at least two less tangency points of tangency with ∇f^\perp than the original γ (which had a point of tangency at $(a_1, a_2)_\gamma$ and other at (a_2, a_3)).

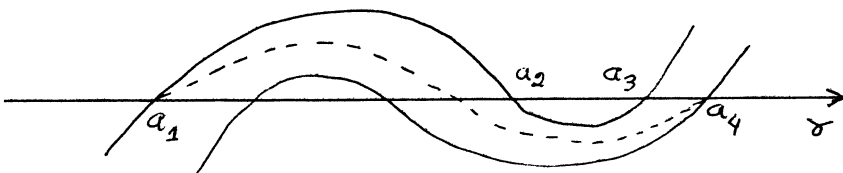

FIG. 3.2

(5) There are three consecutive points a_1, a_2 and a_3 of a positive half-trajectory of ∇f^\perp such that $\gamma \cap [a_1, a_3]_f = [a_1, a_2]_\gamma \cap [a_1, a_3]_f = \{a_1, a_2, a_3\}$.

In this situation, observe first that as $F_{a_3}^+$ is entering through a_3 to the disc bounded by $[a_1, a_3]_f \cup [a_1, a_3]_\gamma$ it must leave this disc at a point $a_4 \in (a_1, a_3)_\gamma$. It is easy to see that ∇f^\perp must meet tangentially somewhere each of the segments $(a_1, a_4)_\gamma, (a_4, a_3)_\gamma$ and $(a_3, a_2)_\gamma$. Therefore, if we consider a small flow box B centered at $[a_1, a_2]_f$ and replace the original $[a_1, a_2]_\gamma$ by a new segment contained in B and having exactly one tangency point with ∇f^\perp at a point a'_2 close to a_2 , as suggested in figure 3.3 we will obtain a new segment that has less number of tangency points with ∇f^\perp than the original γ .

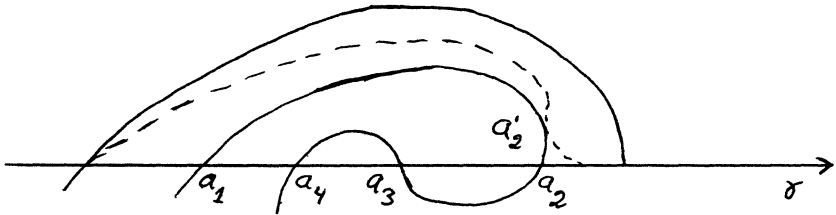

FIG. 3.3

(6) There are three consecutive points a_1, a_2 and a_3 of a positive half-trajectory of ∇f^\perp such that $\gamma \cap [a_1, a_3]_f = [a_3, a_2]_\gamma \cap [a_1, a_3]_f = \{a_1, a_2, a_3\}$.

In this situation, to obtain a curve with fewer tangency points with ∇f^\perp we may proceed as in the case just described.

After a finite number of steps we shall find a curve γ as required in the lemma. \square

LEMMA 3.3. – Let γ be either as in Lemma 3.2 or having the least possible number of tangency points with ∇f^\perp . Then there are numbers

$$r_0 = 0 \leq l_1 < r_1 \leq l_2 < r_2 \leq \dots \leq l_n < r_n \leq 1 = l_{n+1}$$

satisfying (a) and (b) of Proposition 3.1.

Proof. – Let

$$0 < t_1 < t_2 < \dots < t_n < 1$$

be all the real numbers at which γ is tangent to ∇f^\perp . Given i , there exist $r_i > t_i$ and a continuous family $\{L_s^i : s \in (t_i, r_i)\}$ of arc of trajectories

determined by meeting γ exactly at their endpoints and by having $\{\gamma(t_i)\}$ as its limiting set as $s \rightarrow t_i$. The assumptions on γ imply that if r_i is taken to be the greatest possible number, then there must exist l_i such that $\gamma([l_i, r_i])$ is the compact edge of a half-Reeb component.

It is not difficult to see that, thanks to Lemma 3.2, all the conclusions of this lemma are easily obtained. \square

LEMMA 3.4. – *Let γ be as in Lemma 3.2. Then no smooth curve connecting p and q can have fewer points of tangency with ∇f^\perp than γ . Moreover, if $\gamma^* : [0, 1] \rightarrow [F_p, F_q]$ is another curve having this property of γ , then the pair (γ, γ^*) satisfies (c) of Proposition 3.1.*

Proof. – As (a)-(b) of Proposition 3.1 have already been proved, we have numbers r_i^*, t_i^* and l_i^* as in the preceding lemma.

Observe that if $s \in \{l_1, r_1, l_2, r_2, \dots, r_n, l_n\} \setminus \{0, 1\}$ then, as p and q are in different components of $\mathfrak{R}^2 \setminus \mathfrak{F}_{\gamma(s)}$, the curve γ^* has to meet $F_{\gamma(s)}$. Let \tilde{l}_i and \tilde{r}_i be the points in $[0, 1]$ such that $\gamma^*(\tilde{l}_i) \in F_{\gamma(l_i)}$ and $\gamma^*(\tilde{r}_i) \in F_{\gamma(r_i)}$.

One of the edges of C_i , with its given orientation, crosses γ^* from the left side of γ^* to its right one while the other edge does it in the opposed direction. This implies that $\gamma^*([\tilde{l}_i, \tilde{r}_i])$ must be tangent to ∇f^\perp somewhere. Therefore, γ^* must have the same number of points of tangency with ∇f^\perp as γ .

Now we claim that $\gamma^*([\tilde{r}_i, \tilde{l}_{i+1}])$ must be contained in T_i . In fact, otherwise it would cross some trajectory $F_m \notin \{F_{\gamma^*(\tilde{r}_i)}, F_{\gamma^*(\tilde{l}_{i+1})}\}$ belonging to the boundary of T_i . As F_m separates the plane, $\gamma^*([\tilde{r}_i, \tilde{l}_{i+1}])$ would meet F_m at least at two points and so it would contain a tangency point with ∇f^\perp . This would contradict the minimizing property of γ^* . Therefore, $\gamma^*([\tilde{r}_i, \tilde{l}_{i+1}])$ is contained in T_i , $\tilde{r}_i = r_i^*$, $\tilde{l}_{i+1} = l_{i+1}^*$ and so $T_i^* = T_i$ proceeding in this way, the proof of this lemma can easily be completed. \square

4. THE SETS Σ AND Σ_1

Let $p, q \in \mathfrak{R}^2$ be such that $X(p) = X(q) = 0$ and let $[F_p, F_q]$ be the closure of the connected component of $\mathfrak{R}^2 \setminus (\mathfrak{F}_p \cup \mathfrak{F}_q)$ whose boundary is $F_p \cup F_q$. We shall denote by $\Sigma(X, p, q)$ the set of $\theta \in \mathfrak{R}$ such that no transversal region of $[F_p(\theta), F_q(\theta)]$ reduces to a single trajectory of ∇f_θ^\perp . Let $\Sigma_1(X, p, q) = \mathfrak{R} \setminus \Sigma(X, p, q)$. It is clear that $\Sigma_1(X_\theta, H_\theta(p), H_\theta(q)) = \Sigma_1(X, p, q) - \theta = \{t \in \mathfrak{R} : t + \theta \in \Sigma_1(X, p, q)\}$. Therefore, we shall only study the case $0 \in \Sigma_1(X, p, q)$. Let $\gamma : [0, 1] \rightarrow [F_p, F_q]$ be a smooth

curve connecting $\gamma(0) = p$ with $\gamma(1) = q$ and having the least possible number of tangency points with ∇f^\perp . Suppose that γ has generic contact with ∇f^\perp . Let

$$r_0 = 0 \leq l_1 < r_1 \leq l_2 < r_2 \leq \dots \leq l_n < r_n \leq 1 = l_{n+1},$$

T_i and C_i be the real numbers, transversal regions and half-Reeb components, respectively, associated to $([F_p, F_q], \gamma)$ as in Proposition 3.1. We shall say that the sequence

$$\beta = (T_i, C_{i+1}, C_{i+2}, \dots, C_{i+k}, T_{i+k})$$

with length $k \geq 1$, is a *block* of $([F_p, F_q], \gamma)$ if:

- (i) Each of $T_{i+1}, T_{i+2}, \dots, T_{i+k-1}$ is reduced to a single trajectory.
- (ii) Either both T_i and T_{i+k} are not reduced to a single trajectory (in which case β will be called of *type* (T, C, \dots, C, T)) or $T_i = T_0 = F_p$ and T_{i+k} is not reduced to a single trajectory (in which case β will be called of *type* $[C, \dots, C, T)$) or else $T_n = T_{i+k} = F_q$ and T_i is not reduced to a single trajectory (in which case β will be called of *type* (T, C, \dots, C)).

When a half-Reeb component C_{i+j} is on the left of γ (resp. on the right of γ), it will denoted by \cap_{i+j} (resp. \cup_{i+j}) or even simply as \cap (resp. \cup). According as its length is an even or an odd number and also according as C_{i+1} is on the left or on the right of γ , a sequence of type (T, C, \dots, C, T) is from one of the following four subtypes:

- $(T, \cup, \dots, \cap, T)$
- $(T, \cup, \dots, \cup, T)$
- $(T, \cap, \dots, \cup, T)$
- $(T, \cap, \dots, \cap, T)$.

Similarly, there are four subtypes of each one of the sequences $[C, \dots, C, T)$ and $(T, C, \dots, C]$. ■

Under these conditions we have the following

PROPOSITION 4.1. - *Suppose that $0 \in \Sigma_1(X, p, q)$ and extend γ , transversally to ∇f^\perp , to an interval $[-\varepsilon_1, 1 + \varepsilon_1]$. There exists $\varepsilon > 0$ and continuous functions*

$$L_i, R_i : [-\varepsilon, \varepsilon] \rightarrow [-\varepsilon_1, 1 + \varepsilon_1]$$

with $L_i(0) = l_i, R_i(0) = r_i$, such that if

$$\beta = (T_i, C_{i+1}, \dots, C_{i+k}, T_{i+k})$$

is a block of $([F_p, F_q], \gamma)$, then, for $\theta \in (-\varepsilon, \varepsilon)$, it can be constructed a smooth curve $\lambda_\theta : [0, 1] \rightarrow [F_p(\theta), F_q(\theta)]$, with $\lambda_0 = \gamma$, connecting $H_\theta(p)$

with $H_\theta(q)$, having the least possible number of points of tangency with ∇f_θ^\perp and, in such a way, that one of the twelve statements, (4.1,1)-(4.1,12), of figure 4.1, is satisfied. Each line of such figure corresponds to a pair of conclusions. The way of interpreting each line is the same in all cases. The figures 4.1,1-4.1,12 are related to the statements 4.1,1-4.1,12 of figure 4.1.

Proceed to explain the diagram

$$(T, \overline{T}, T) \rightarrow (T, \overline{\cap, \dots, \cup}, T)$$

which appears in the left side of the first line of figure 4.1. By putting θ and suffixes in evidence this diagram becomes

$$(T_i(\theta), \overline{T(\theta)}, T_{i+k}(\theta)) \rightarrow (T_i, \overline{\cap_{i+1}, \dots, \cup_{i+k}}, T_{i+k})$$

where $\beta = (T_i, \cap_{i+1}, \dots, \cup_{i+k}, T_{i+k})$ is in the right side because the conclusions refer to values $\theta < 0$. In this case the following is satisfied

(a) $T_i(\theta)$, $T(\theta)$ and $T_{i+k}(\theta)$ consist of trajectories that belong to a transversal region of $[F_p(\theta), F_q(\theta)]$ and $T(\theta)$ is always a connected set not reduced to a single trajectory.

(b) There are no lines on top of $T_i(\theta)$ and T_i (resp. $T_{i+k}(\theta)$ and T_{i+k}) because λ_θ and $H_\theta \circ \gamma$ coincide in $[R_i(\theta), L_{i+1}(\theta)]$ (resp. $[R_{i+k}(\theta), L_{i+k+1}(\theta)]$) and $T_i(\theta)$ is made of all trajectories of ∇f_θ^\perp that meet $H_\theta \circ \gamma([R_i(\theta), L_{i+1}(\theta)])$ (resp. $H_\theta \circ \gamma([R_{i+k}(\theta), L_{i+k+1}(\theta)])$).

(c) As $\cap_{i+1}, \dots, \cup_{i+k}$ is not an empty sequence and there are lines on top of $T(\theta)$ and $\cap_{i+1}, \dots, \cup_{i+k}$, the curve λ_θ , restricted to $[L_{i+1}(\theta), R_{i+k}(\theta)]$, cannot taken to be close to $H_\theta \circ \gamma$. Also, the trajectories that meet $H_\theta \circ \gamma([L_{i+1}(\theta), R_{i+k}(\theta)])$ form $T(\theta)$. Moreover, $\gamma([l_{i+1}, r_{i+k}])$ is made up of the compact edges of $\cap_{i+1}, \dots, \cup_{i+k}$.

In the same way, the right part of the first line of figure 4.1

$$(T, \cap, \overline{\cup, \dots, \cap}, \cup, T) \rightarrow (T, \cap, \overline{T}, \cup, T)$$

refers to values $\theta > 0$ because $\beta = (T, \cap, \cup, \dots, \cap, \cup, T)$ is on the left side. The meaning of this diagram can be deduced in the same way as that of the case above. However, there is a new situation when $k = 2$ and so $\overline{\cup, \dots, \cap}$ represents an empty sequence. In this particular case λ_θ coincides with $H_\theta \circ \gamma$ in $[R_i(\theta), L_{i+k+1}(\theta)]$.

There is no new situation in all remaining cases. There is a special case in the third (resp. fourth) line when $k = 1$. In this case the block is stable and the diagram could also be written as

$$(T, \cap, T) \rightarrow (T, \cap, T) \rightarrow (T, \cap, T).$$

Type (T, C, \dots, C, T)

4.1,1

$$(T, \bar{T}, T) \rightarrow (T, \overline{\bar{\cap}, \dots, \cup}, T) = (T, \cap, \overline{\cup, \dots, \bar{\cap}}, \cup, T) \rightarrow (T, \cap, \bar{T}, \cup, T)$$

4.1,2

$$(T, \cup, \bar{T}, \cap, T) \rightarrow (T, \cup, \overline{\bar{\cap}, \dots, \cup}, \cap, T) = (T, \cup, \dots, \bar{\cap}, T) \rightarrow (T, \bar{T}, T)$$

4.1,3

$$(T, \bar{T}, \cap, T) \rightarrow (T, \overline{\bar{\cap}, \dots, \cup}, \cap, T) = (T, \cap, \overline{\cup, \dots, \bar{\cap}}, T) \rightarrow (T, \cap, \bar{T}, T)$$

4.1,4

$$(T, \cup, \bar{T}, T) \rightarrow (T, \cup, \overline{\bar{\cap}, \dots, \cup}, T) = (T, \cup, \dots, \bar{\cap}, \cup, T) \rightarrow (T, \bar{T}, \cup, T)$$

Type $[C, \dots, C, T]$

4.1,5

$$[\bar{T}, T] \rightarrow [\overline{\bar{\cap}, \dots, \cup}, T] = [\overline{\bar{\cap}, \dots, \bar{\cap}, \cup}, T] \rightarrow [\bar{T}, \cup, T]$$

4.1,6

$$[\bar{T}, \cap, T] \rightarrow [\cup, \dots, \cup, \cap, T] = [\cup, \dots, \bar{\cap}, T] \rightarrow [\bar{T}, T]$$

4.1,7

$$[\bar{T}, \cap, T] \rightarrow [\overline{\bar{\cap}, \dots, \cup}, \cap, T] = [\overline{\bar{\cap}, \dots, \bar{\cap}}, T] \rightarrow [\bar{T}, T]$$

4.1,8

$$[\bar{T}, T] \rightarrow [\cup, \dots, \cup, T] = [\cup, \dots, \bar{\cap}, \cup, T] \rightarrow [\bar{T}, \cup, T]$$

Type (T, C, \dots, C)

4.1,9

$$(T, \bar{T}) \rightarrow (T, \overline{\bar{\cap}, \dots, \cup}) = (T, \cap, \overline{\cup, \dots, \bar{\cap}}) \rightarrow (T, \cap, \bar{T})$$

4.1,10

$$(T, \cup, \bar{T}) \rightarrow (T, \cup, \overline{\bar{\cap}, \dots, \bar{\cap}}) = (T, \cup, \dots, \bar{\cap}) \rightarrow (T, \bar{T})$$

4.1,11

$$(T, \bar{T}) \rightarrow (T, \overline{\bar{\cap}, \dots, \bar{\cap}}) = (T, \cap, \overline{\cup, \dots, \bar{\cap}}) \rightarrow (T, \cap, \bar{T})$$

4.1,12

$$(T, \cup, \bar{T}) \rightarrow (T, \cup, \overline{\bar{\cap}, \dots, \cup}) = (T, \cup, \dots, \bar{\cap}) \rightarrow (T, \bar{T})$$

FIG. 4.1

The proof of Proposition 4.1 follows immediately from Lemmas 4.2-4.7. The proof of the following lemma is a direct corollary of Lemma 2.5.

Type $(T, \cap, \dots, \cup, T)$

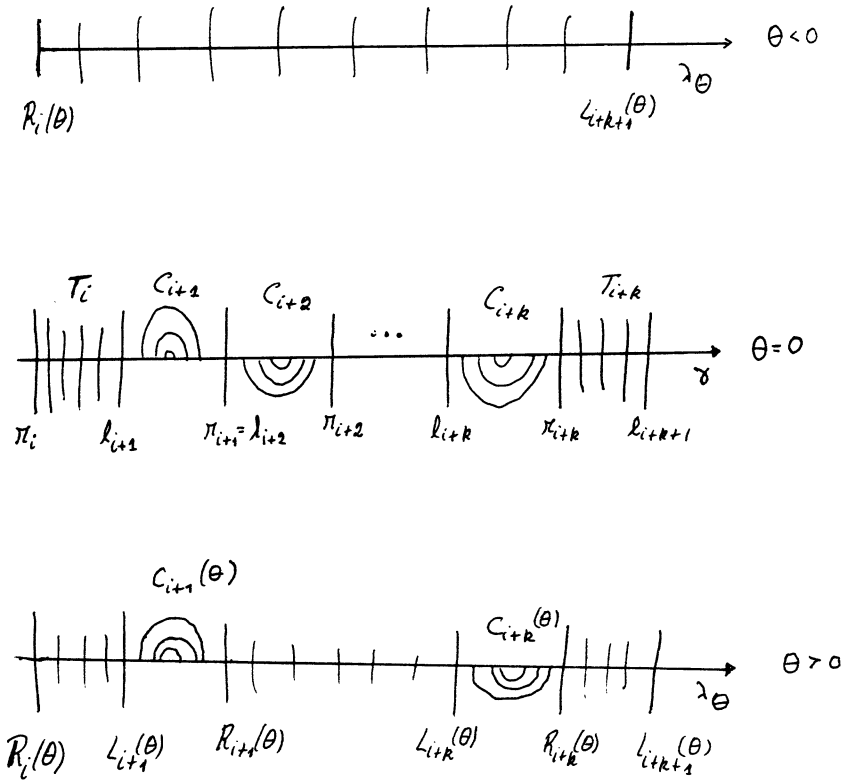

FIG. 4.1,1,a

LEMMA 4.2. – If $\varepsilon > 0$ is small enough, there are continuous monotone functions

$$L_i, R_i : [-\varepsilon, \varepsilon] \rightarrow [-\varepsilon_1, 1 + \varepsilon_1]$$

such that, for all $i \in \{1, 2, \dots, n\}$, $H_\theta \circ \gamma([L_i(\theta), R_i(\theta)])$ is the compact edge of a half-Reeb component $C_i(\theta)$ of ∇f^\perp , associated to $H_\theta \circ \gamma$, in the sense of Lemma 2.5.

LEMMA 4.3. – Given $\varepsilon > 0$ small, for all $\theta \in (-\varepsilon, \varepsilon)$, $[F_p(\theta), F_q(\theta)]$ contains at least two transversal regions.

Proof. – As p and q are singularities of X , $H_\theta(p)$ and $H_\theta(q)$ will be singularities of X_θ . Because the rest of the argument will depend only on this fact and not on the particular θ , we shall only consider $[F_p, F_q]$.

Assume first that $[F_p, F_q]$ has no transversal region and that C_1 is on the left of γ . This implies, by Proposition 2.1, that if i is an odd number (resp.

Type $(T, \cup, \dots, \cap, T)$

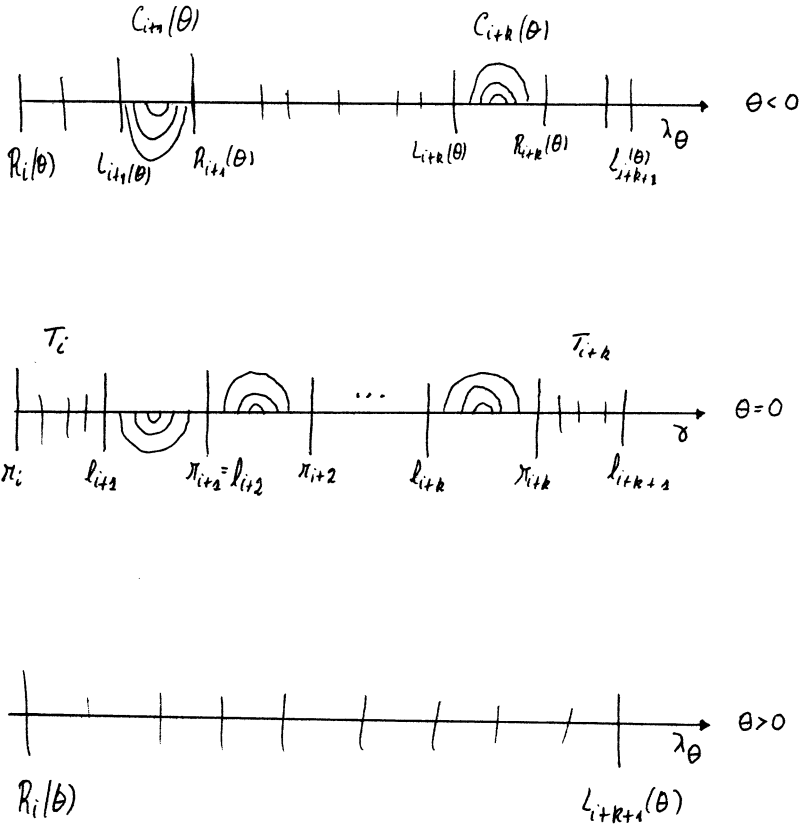

FIG. 4.1.2

even number), C_i is on the left (resp. on the right) of γ . Suppose moreover that ∇f points inward C_1 along its non-compact edges and so that they are $F_{\gamma(l_1)}^+$ and $F_{\gamma(r_1)}^-$. As $\text{Det}(DX) > 0$ everywhere, g is strictly increasing along trajectories of the vector field ∇f^\perp ; therefore, $g(\gamma(l_1)) < g(\gamma(r_1))$. Similarly, $g(\gamma(r_1)) = g(\gamma(l_2)) < g(\gamma(r_2))$. Proceeding in this way we shall find that $g(p) < g(q)$ which is a contradiction. By using the same argument in all the other possibilities, we may conclude that $[F_p, F_q]$ must have at least one transversal region.

Now if we assume that $[F_p, F_q]$ has exactly one transversal region, by the same argument above, we would conclude that $f(p) \neq f(q)$ which would be again a contradiction.

Type (T, U, \dots, U, T)

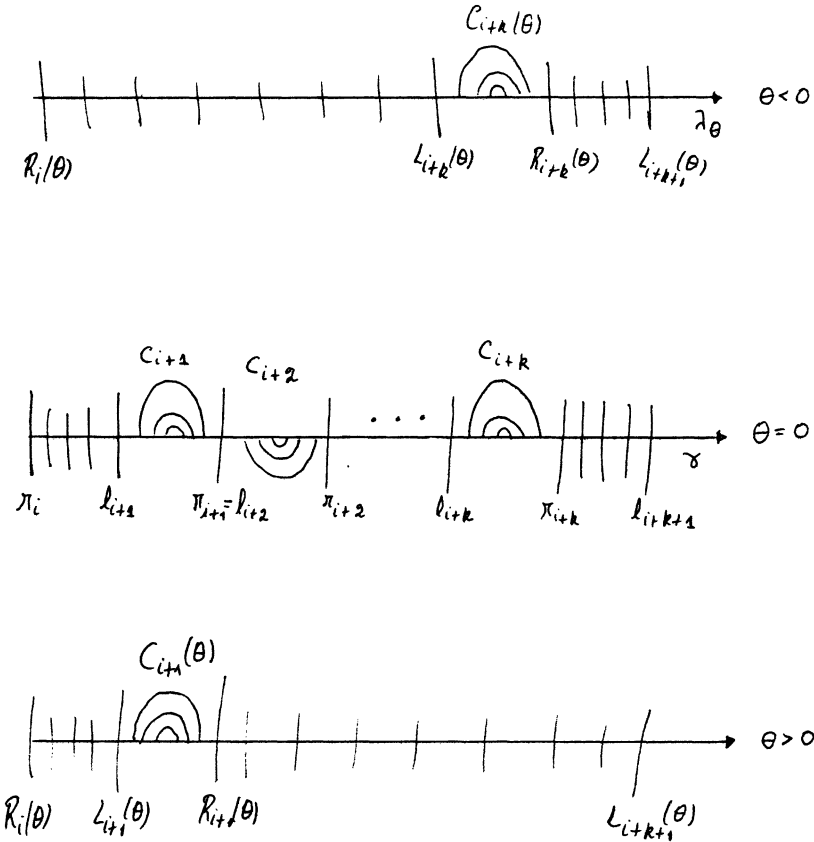

FIG. 4.1.3

LEMMA 4.4. – Let $i \in \{0, 1, \dots, n\}$ be such that $r_i < l_{i+1}$. If $\varepsilon > 0$ is small enough then, for all $\theta \in (-\varepsilon, \varepsilon)$, $H_\theta \circ \gamma([R_i(\theta), L_{i+1}(\theta)])$ is contained in a transversal region of $[F_p(\theta), F_q(\theta)]$.

Proof. – Fix $\theta \in (-\varepsilon, \varepsilon)$. If we assumed by contradiction that there existed an arc of trajectory $[a_1, a_2]_{f_\theta}$ (of ∇f_θ^\perp) meeting $H_\theta \circ \gamma$ exactly at its endpoints with $a_1 \in H_\theta \circ \gamma([R_i(\theta), L_{i+1}(\theta)])$, this would imply the existence of a half-Reeb component associated to $H_\theta \circ \gamma$ (in the context of Lemmas 2.5 and 4.2) and containing $[a_1, a_2]_{f_\theta}$. This contradiction with Lemma 4.2 proves the lemma.

LEMMA 4.5. – Let $i \in \{1, 2, \dots, n-1\}$. Suppose that $l_i < r_i = l_{i+1} < r_{i+1}$ and that $\varepsilon > 0$ is very small.

Type $(T, \cap, \dots, \cap, T)$

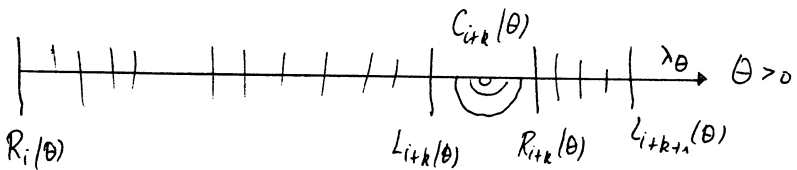
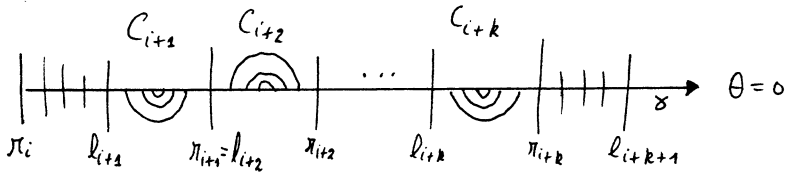
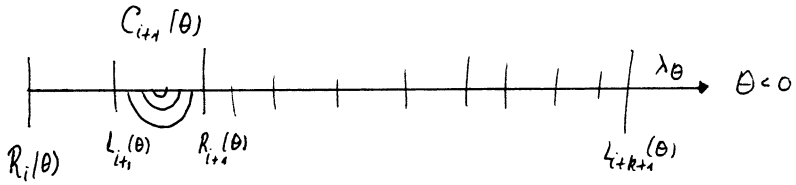

FIG. 4.1,4

(a) If the half-Reeb component C_i (having $\gamma([l_i, r_i])$ as its compact edge) is on the left of γ then, for $\theta \in (0, \varepsilon)$, $H_\theta \circ \gamma([R_i(\theta), L_{i+1}(\theta)])$ is contained in a transversal region of $[F_p(\theta), F_q(\theta)]$. See fig. 4.2,a

(b) If the half-Reeb component C_i (having $\gamma([l_i, r_i])$ as its compact edge) is on the right of γ then, for $\theta \in (-\varepsilon, 0)$, $H_\theta \circ \gamma([R_i(\theta), L_{i+1}(\theta)])$ is contained in a transversal region of $[F_p(\theta), F_q(\theta)]$ and for, $\theta \in (0, \varepsilon)$, $H_\theta \circ \gamma([L_i(\theta), R_{i+1}(\theta)])$ is contained in a transversal region of $[F_p(\theta), F_q(\theta)]$.

Proof. - Let us prove the item (a) when $\theta \in (-\varepsilon, 0)$. In this case, $L_{i+1}(\theta) < R_i(\theta)$ and we may construct a smooth curve λ_θ , as suggested in figure 4.2,a, contained in $[F_p(\theta), F_q(\theta)]$, that coincides with $H_\theta \circ \gamma$ in the complement of $[L_i(\theta), R_{i+1}(\theta)]$ and that, when restricted to $[L_i(\theta), R_{i+1}(\theta)]$, is transversal to ∇f_θ^\perp . Let us assume, by contradiction,

Type $[\cap, \dots, \cup, T)$

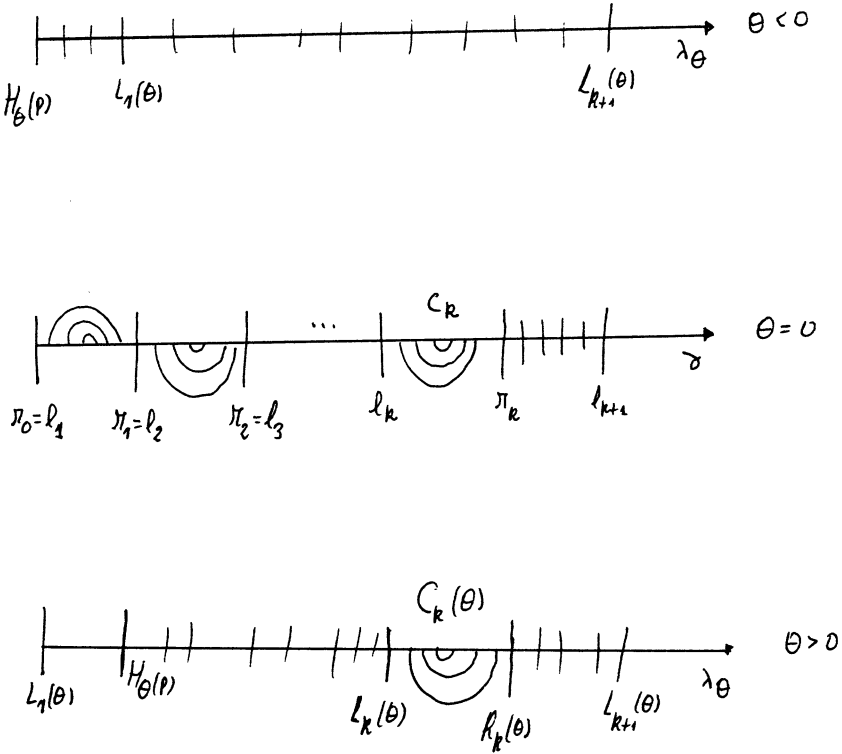

FIG. 4.1,5

that there exists an arc of trajectory $[a_1, a_2]_{f_\theta}$ (of ∇f_θ^\perp) meeting λ_θ exactly at its endpoints with $a_1 \in \lambda_\theta([L_i(\theta), R_{i+1}(\theta)])$. By the required transversality, a_2 cannot belong to $\lambda_\theta([L_i(\theta), R_{i+1}(\theta)])$. In particular a_2 belongs to $H_\theta \circ \gamma([0, 1] \setminus [L_i(\theta), R_{i+1}(\theta)])$. By the orbit structure of ∇f_θ , there must exist an arc of trajectory of ∇f_θ of the form $[b_1, a_2]_{f_\theta}$ meeting $H_\theta \circ \gamma$ exactly at its endpoints with $b_1 \in H_\theta \circ \gamma([L_i(\theta), R_{i+1}(\theta)])$. This implies the existence of a half-Reeb component associated to $H_\theta \circ \gamma$ (in the context of lemmas 2.5 and 4.2) and containing $[b_1, a_2]_{f_\theta}$. This contradiction with Lemma 4.2 proves this lemma.

LEMMA 4.6. – Suppose that $r_0 = l_1$ and that $\varepsilon > 0$ is very small.

(a) If the half-Reeb component C_1 (having $\gamma([l_1, r_1])$ as its compact edge) is on the left of γ then, there is a continuous function $\sigma : [0, \varepsilon] \rightarrow [0, r_1]$ such that $\sigma(0) = r_1$, $0 < \sigma(\theta) \leq R_1(\theta)$, and $H_\theta(p)$ and $H_\theta \circ \gamma(\sigma(\theta))$ are the endpoints of the subarc of $F_p(\theta)$ that is on the left of γ and that meets

Type $[U, \dots, \cap, T)$ 

FIG. 4.1,6

$H_\theta \circ \gamma$ exactly at its endpoints. Also, $H_\theta \circ \gamma([\sigma(\theta), R_1(\theta)])$ is contained in a transversal region of $[F_p(\theta), F_q(\theta)]$. Moreover, for, $\theta \in (-\varepsilon, 0)$, $H_\theta \circ \gamma([0, L_1(\theta)])$ is contained in a transversal region of $[F_p(\theta), F_q(\theta)]$. See fig. 4.3.a.

(b) If the half-Reeb component C_1 (having $\gamma([l_1, r_1])$ as its compact edge) is on the right of γ then, there is a continuous function $\sigma : (-\varepsilon, 0] \rightarrow [0, r_1]$ such that $\sigma(0) = r_1$, $0 < \sigma(\theta) \leq R_1(\theta)$, and $H_\theta(p)$ and $H_\theta \circ \gamma(\sigma(\theta))$ are the endpoints of the subarc of $F_p(\theta)$ that is on the right of γ and that meets $H_\theta \circ \gamma$ exactly at its endpoints. Also, $\gamma([\sigma(\theta), R_1(\theta)])$ is contained in a transversal region of $[F_p(\theta), F_q(\theta)]$. Moreover, for, $\theta \in [0, \varepsilon)$, $H_\theta \circ \gamma([0, L_1(\theta)])$ is contained in a transversal region of $[F_p(\theta), F_q(\theta)]$. See fig. 4.3.b.

Proof. – Let us prove the item (a) when $\theta \in (0, \varepsilon)$. In this case, $0 > L_1(\theta)$ and so, by Lemma 2.2 and Lemma 2.5, (d), there must exist a function

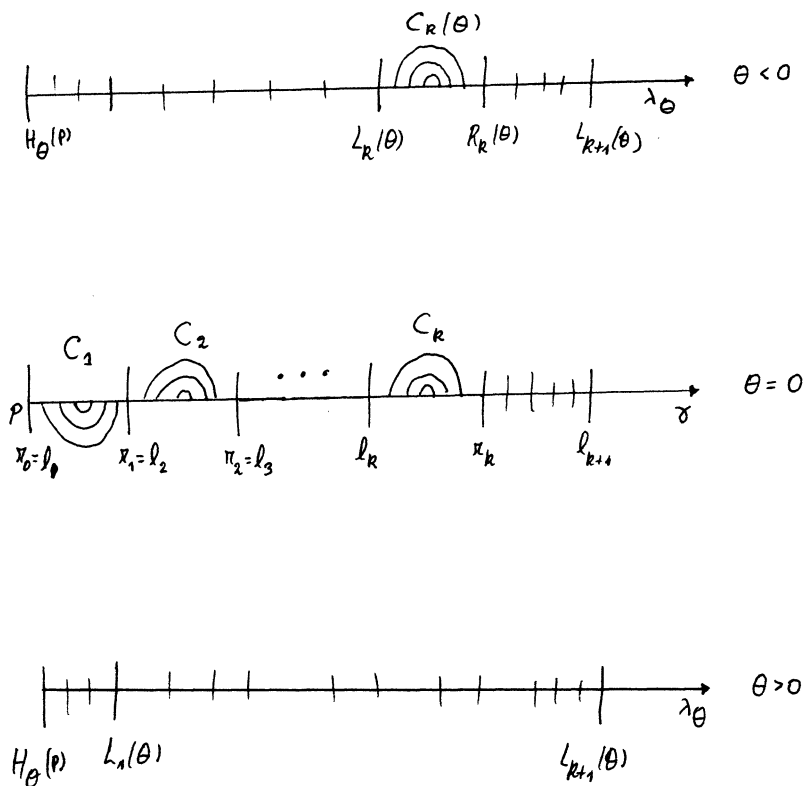
Type $[\cap, \dots, \cap, T)$

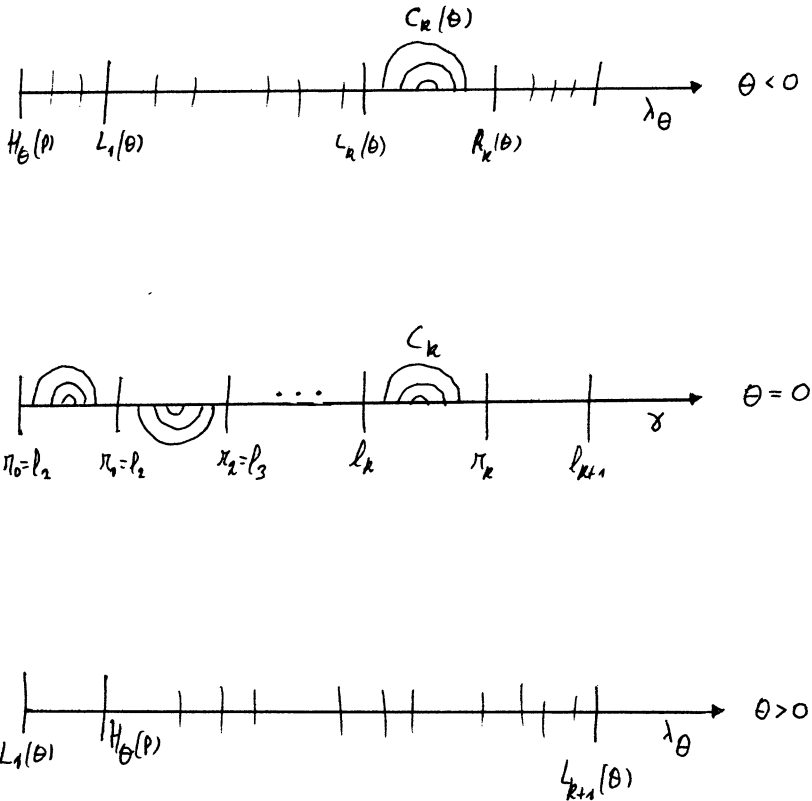

FIG. 4.1.7

σ as required. The proof of the remainder of (a) is similar to that of Lemma 4.4: We construct a smooth curve $\lambda_\theta : [0, 1] \rightarrow [F_p(\theta), F_q(\theta)]$, as drawn in dotted lines in figure 4.3,a, that coincides with $H_\theta \circ \gamma|_{[0,1]}$ in the complement of $[0, R_1(\theta)]$ and, when restricted to $[0, R_1(\theta)]$, is transversal to ∇f_θ^\perp . Using a similar argument to that of Lemma 4.4, we may show that trajectories of ∇f_θ^\perp can meet $\lambda_\theta([0, R_1(\theta)])$ at most once. This implies, by Proposition 3.1, our claim.

LEMMA 4.7. – Suppose that $r_n = l_{n+1}$ and that $\varepsilon > 0$ is very small.

(a) If the half-Reeb component C_n (having $\gamma([l_n, r_n])$ as its compact edge) is on the right of γ then, there is a continuous function $\sigma : [0, \varepsilon] \rightarrow [l_n, 1]$ such that $\sigma(0) = l_n$, $1 > \sigma(\theta) \geq L_n(\theta)$, and $H_\theta(q)$ and $H_\theta \circ \gamma(\sigma(\theta))$ are the endpoints of the subarc of $F_q(\theta)$ that is on the right of γ and that meets $H_\theta \circ \gamma$ exactly at its endpoints. Also, $H_\theta \circ \gamma([L_n(\theta), \sigma(\theta)])$ is contained

Type $[\cup, \dots, \cup, T)$

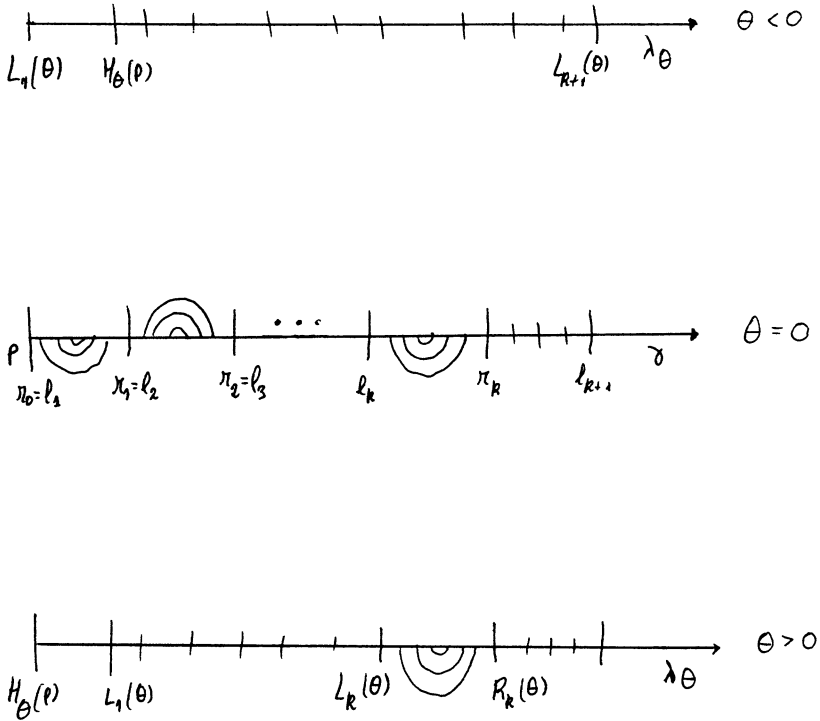

FIG. 4.1,8

in a transversal region of $[F_p(\theta), F_q(\theta)]$. Moreover, for $\theta \in (-\varepsilon, 0)$, $H_\theta \circ \gamma([R_n(\theta), 1])$ is contained in a transversal region of $[F_p(\theta), F_q(\theta)]$.

(b) If the half-Reeb component R_n (having $\gamma([l_n, r_n])$ as its compact edge) is on the left of γ then, there is a continuous function $\sigma : (-\varepsilon, 0] \rightarrow [l_n, 1]$ such that $\sigma(0) = l_n$, $1 > \sigma(\theta) \geq L_n(\theta)$, and $H_\theta(p)$ and $H_\theta \circ \gamma(\sigma(\theta))$ are the endpoints of the subarc of $F_p(\theta)$ that is on the left of γ and that meets $H_\theta \circ \gamma$ exactly at its endpoints. Also, $\gamma([L_n(\theta), \sigma(\theta)])$ is contained in a transversal region of $[F_p(\theta), F_q(\theta)]$. Moreover, for $\theta \in [0, \varepsilon)$, $H_\theta \circ \gamma([R_n(\theta), 1])$ is contained in a transversal region of $[F_p(\theta), F_q(\theta)]$.

COROLLARY 4.8. - (a) $\Sigma_1(X, p, q)$, modulo 2π , consists of a finite set of points.

(b) If θ_1, θ_2 belong to the same connected component of $\Sigma(X, p, q) \setminus \Sigma_1(X, p, q)$, then the canonical decompositions of $([F_p(\theta_1), F_q(\theta_1)], \lambda_{\theta_1})$ and $([F_p(\theta_2), F_q(\theta_2)], \lambda_{\theta_2})$, as given by Proposition 3.1, are essentially the same:

Type (T, \cap, \dots, \cup)

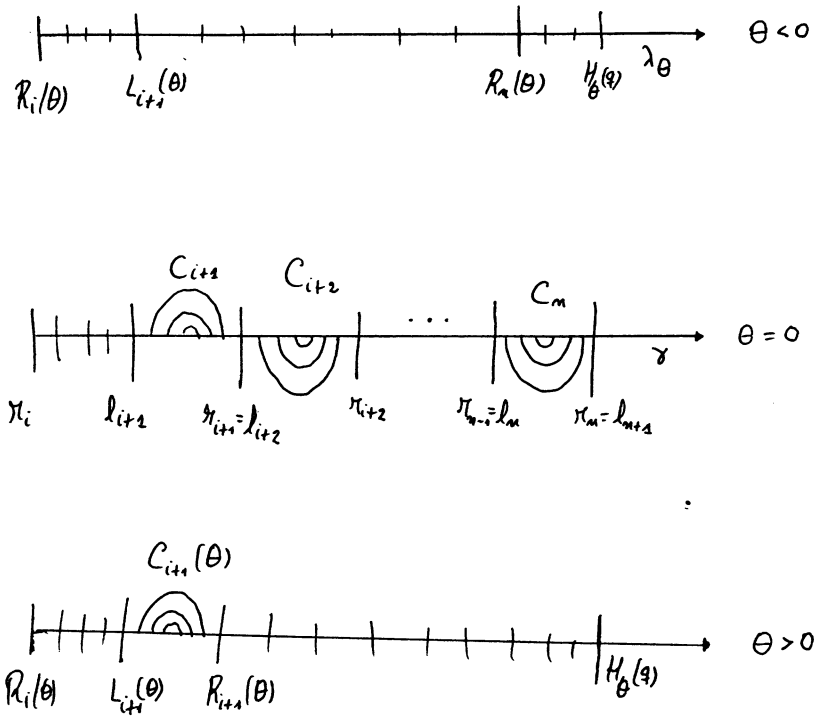

FIG. 4.1,9

- b1) They have the same number of transversal regions and half-Reeb components,
- b2) every transversal region of both is not reduced to a single orbit,
- and
- b3) provided that half-Reeb components of both are ordered as in Proposition 3.1, the ones in correspondence are both simultaneously on the right or on the left of the related curve λ_{θ_s} .

Remark 4.9. – The elements of $\Sigma(X, p, q)$ behave as the stable systems and those of $\Sigma_1(x, p, q)$ are the bifurcating ones.

The proof of Theorem A, done in Section 5, will be obtained by studying the behaviour of the canonical decomposition of $([F_p(\theta), F_q(\theta)], \lambda_\theta)$, as θ varies in \mathfrak{R} .

Type $(T, U, \dots, \cap]$

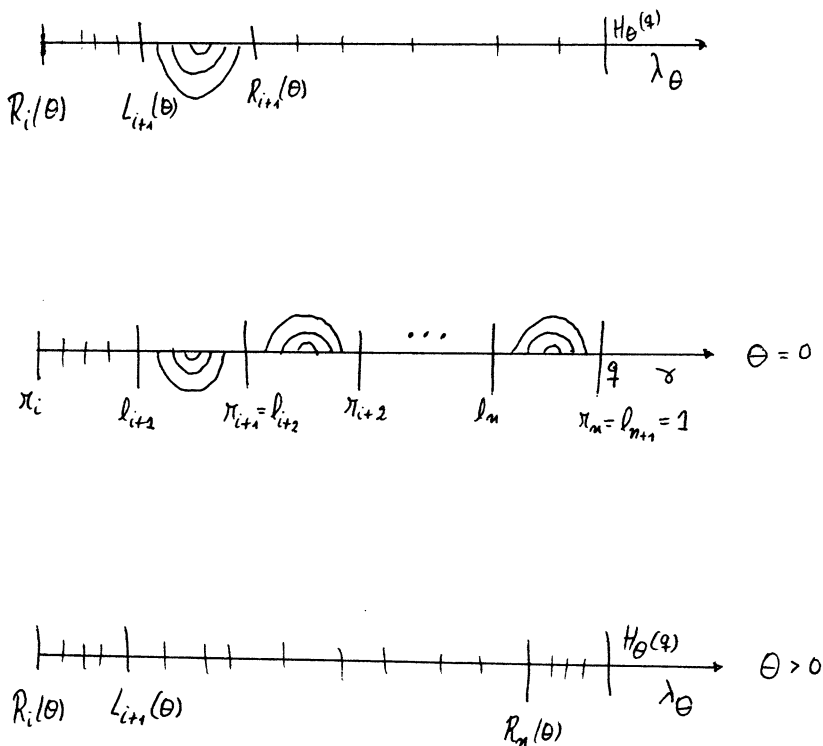

FIG. 4.1.10

5. PROOF OF THEOREM A

THEOREM A. – Any smooth map $X : \mathfrak{R}^2 \rightarrow \mathfrak{R}^2$ satisfying the ρ -eigenvalue condition, for some $\rho \in [0, \infty)$, is injective.

Proof. – Suppose by contradiction that X is not injective. Then, by composing X with a translation, it can be assumed that there exists $p, q \in \mathfrak{R}^2$ such that $X(p) = X(q) = 0$. Let $\gamma : [0, 1] \rightarrow [F_p, F_q]$ be a smooth curve connecting $\gamma(0) = p$ with $\gamma(1) = q$ and having the least possible number of tangency points with ∇f^\perp . Suppose that γ has generic contact with ∇f^\perp . Let

$$r_0 = 0 \leq l_1 < r_1 \leq l_2 < r_2 \leq \dots \leq l_n < r_n \leq 1 = l_{n+1},$$

and

$$(T_0, C_1, T_1, C_2, T_2, \dots, C_n, T_n)$$

Type $(T, \cap, \dots, \cap]$

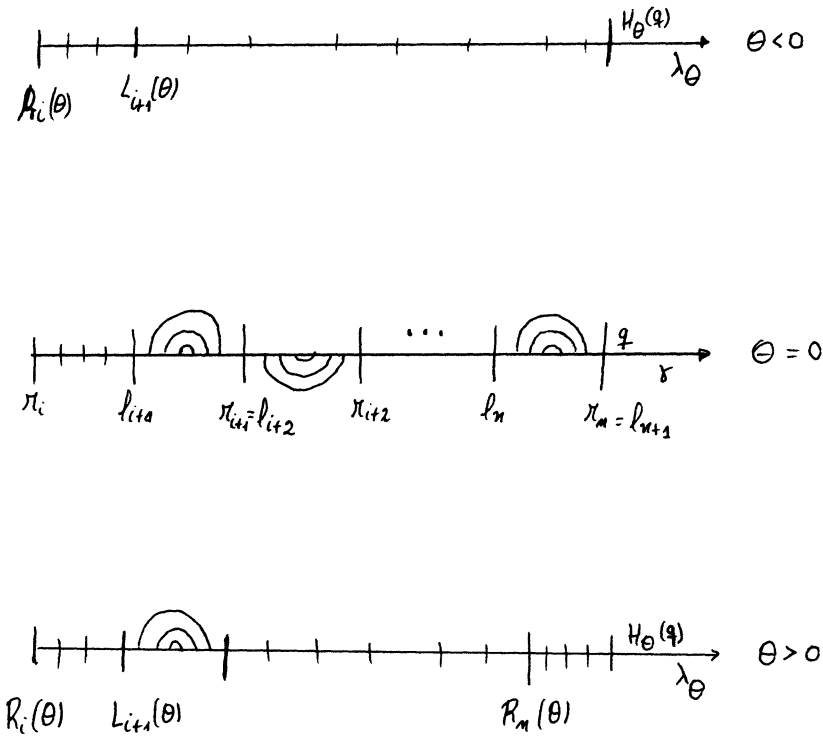

FIG. 4.1.11

be the sequence of real numbers and the sequence made up of transversal regions and half-Reeb components, respectively, associated to $([F_p, F_q], \gamma)$ as in Proposition 3.1.

Given $\theta \in \mathfrak{R}/2\pi\mathbb{Z}$ choose a smooth curve $\lambda_\theta : [0, 1] \rightarrow [F_p(\theta), F_q(\theta)]$ connecting $\lambda_\theta(0) = H_\theta(p)$ with $\lambda_\theta(1) = H_\theta(q)$ and having the least possible number of tangency points with ∇f_θ^\perp . Suppose that $\lambda_0 = \gamma$. For all $\theta \in \mathfrak{R}$, let $T_0(\theta)$ and $D_1(\theta)$ be the first transversal region and half-Reeb component, respectively, associated to $([F_p(\theta), F_q(\theta)], \lambda_\theta)$ as in Proposition 3.1. In particular, $T_0(0) = T_0$ and $D_1(0) = C_1$. We shall denote by $B_1(\theta)$ the only trajectory of ∇f_θ^\perp that contains $T_0(\theta) \cap D_1(\theta)$.

By replacing X by X_θ if necessary, we may assume that T_0 does not consist of a single trajectory.

Let L_1, L_2, \dots, L_k be C^1 embedded images of \mathfrak{R} such that each of them separates the plane into two connected components. We say that $\{L_1, L_2, \dots, L_k\}$ is a (p, q) -separating sequence if, for all $j \in$

Type $(T, U, \dots, U]$

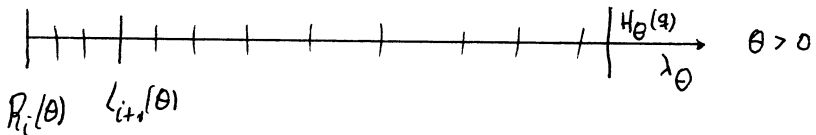
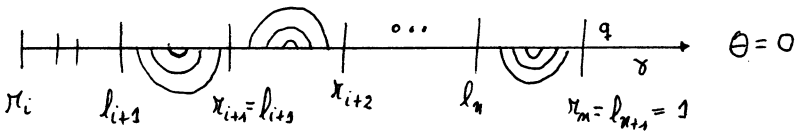
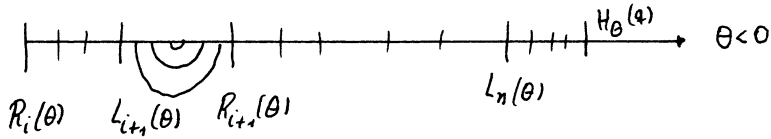

FIG. 4.1,12

$\{1, 2, \dots, k\}$,

$$\{p\} \cup L_1 \cup \dots \cup L_{j-1} \quad \text{and} \quad L_{j+1} \cup \dots \cup L_k \cup \{q\}$$

are contained in different connected components of $\mathfrak{R}^2 \setminus \mathcal{L}_j$, where L_0 and L_{k+1} denote the empty set.

To proceed with the proof we shall need the following:

LEMMA 5.1. — *Let suppose that C_1 is on the right of γ (resp. on the left of γ). If $\varepsilon > 0$ is small enough and $0 \leq \theta < \varepsilon$ (resp. $0 \geq \theta > -\varepsilon$), then $\{B_1(0), H_\theta^{-1}(B_1(\theta))\}$ is a (p, q) -separating sequence, and also $D_1(\theta)$ is on the right of λ_θ (resp. on the left of λ_θ).*

Proof. — We shall only consider the case in which $C_1 = U_1$ is on the right of γ .

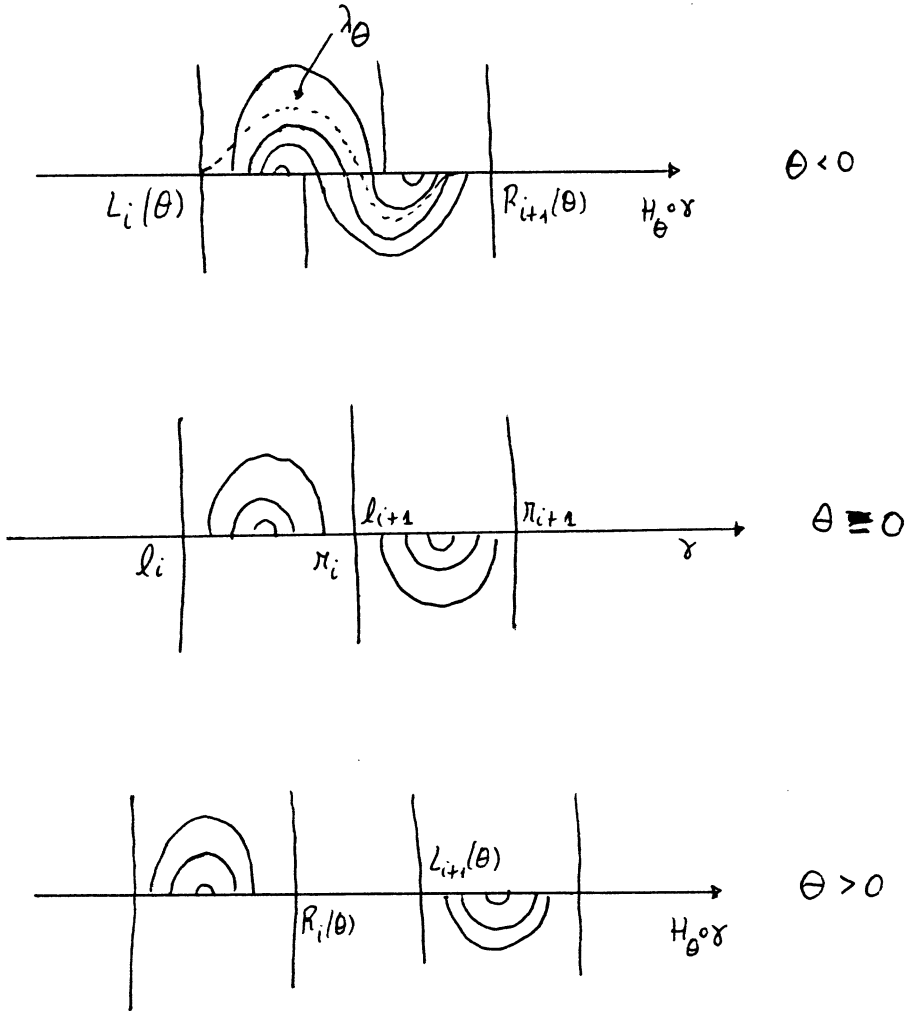

FIG. 4.2,a

Suppose first that $0 \in \Sigma(X, p, q)$. This implies that all the blocks of $([F_p, F_q], \gamma)$ are of type (T, C, \dots, C, T) and have length 1. This means that the blocks are either of the form (T, \cup, T) or (T, \cap, T) . Hence, for θ small, λ_θ can be taken to be equal to $H_\theta \circ \gamma$. Let $\varepsilon > 0$, $L_i(\theta)$ and $R_i(\theta)$ be as in Proposition 4.1. It follows from claim 4.1.4 of this proposition (which in this case takes the form $(T, \cup, T) \rightarrow (T, \cup, T) \rightarrow (T, \cup, T)$) and from Lemma 2.5,(d), that $L_1(\theta)$ and $R_1(\theta)$ are strictly increasing functions of θ (with $L_1(0) = l_1$, $R_1(0) = r_1$), that $D_1(\theta)$ is on the right of λ_θ and has

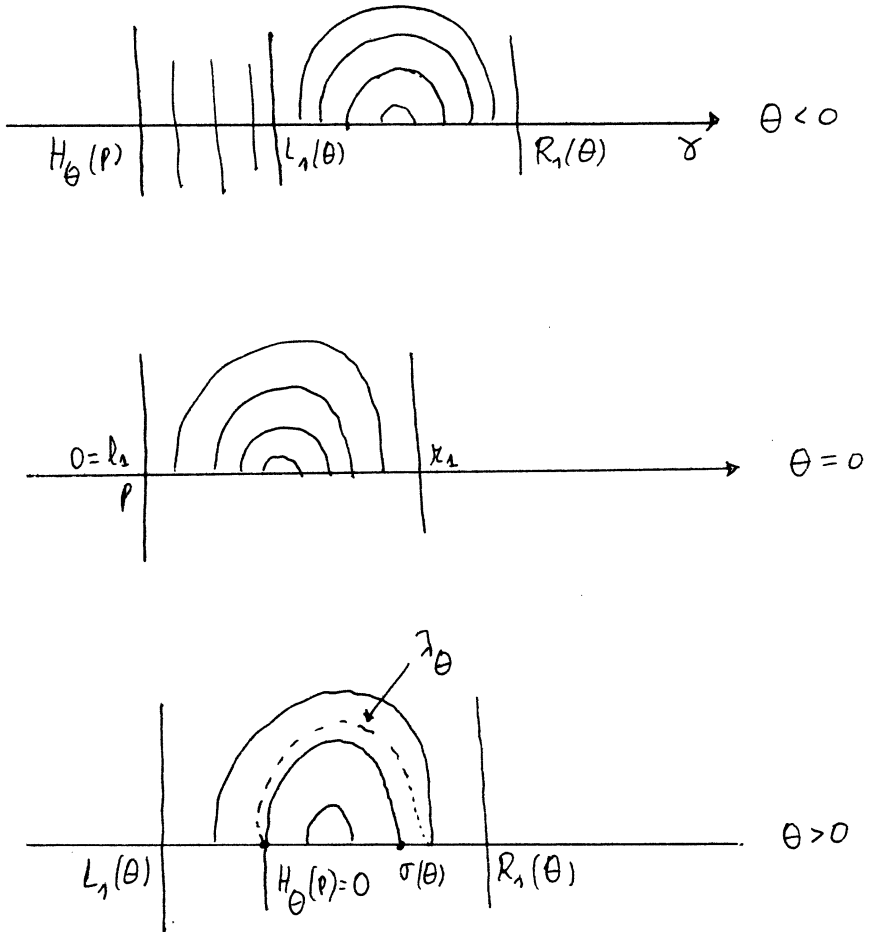

FIG. 4.3,a

$H_\theta \circ \gamma([L_1(\theta), R_1(\theta)])$ as its compact edge and also that the trajectory of ∇f_θ^\perp passing through $H_\theta \circ \gamma(L_1(\theta))$ is precisely $B_1(\theta)$. Given $\theta \in (0, \varepsilon)$, denote by $F_{\gamma(t_1)}(\theta)$ the trajectory of ∇f_θ^\perp passing through $H_\theta(\gamma(t_1))$. (See fig. 5.1).

It follows from Lemma 2.2 that

(1) $H_\theta((B_1(0)))$ is transversal to ∇f_θ^\perp and meets $F_{\gamma(t_1)}(\theta)$ exactly at $H_\theta(\gamma(t_1))$.

Hence, as the connected component of $F_{\gamma(t_1)}(\theta) \setminus \{H_\theta(\gamma(t_1))\}$, contained in the left side of $H_\theta \circ \gamma$, is disjoint of $B_1(\theta)$, we must also have that the connected component of $H_\theta((B_1(0))) \setminus \{H_\theta(\gamma(t_1))\}$ contained in the left side of $H_\theta \circ \gamma$ is disjoint of $B_1(\theta)$. Therefore, as $B_1(\theta)$

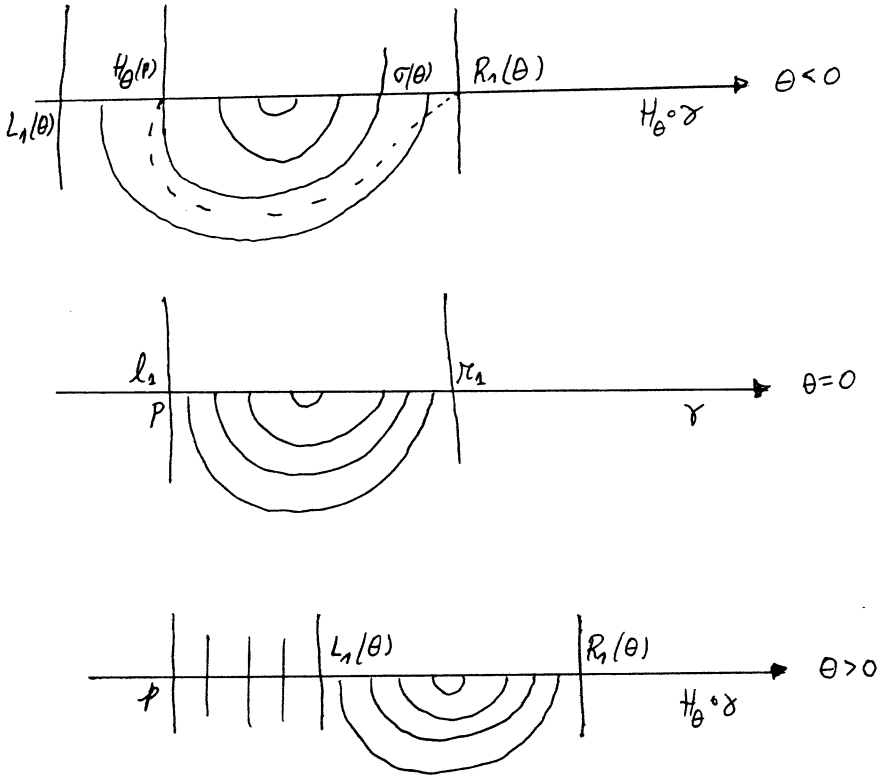

FIG. 4.3,b

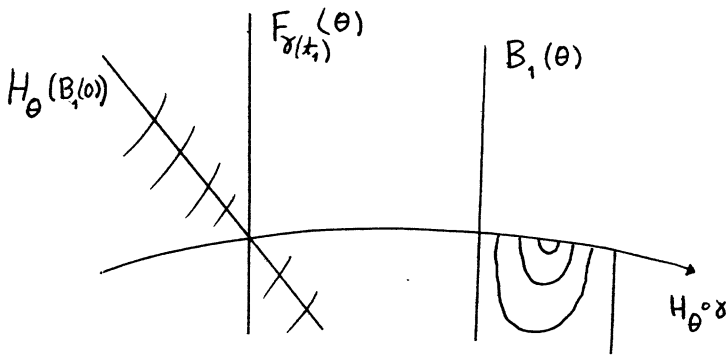

FIG. 5.1

contains the edge of $D_1(\theta)$ (which is on the right of $H_\theta \circ \gamma$) it must be that not only $H_\theta((B_1(0)))$ is disjoint of $B_1(\theta)$ but also that $\{H_\theta((B_1(0))), B_1(\theta)\}$ is a $(H_\theta(p), H_\theta(q))$ -separating sequence. This implies

that $\{B_1(0), H_\theta^{-1}(B_1(\theta))\}$ is a (p, q) -separating sequence. In the case considered the lemma follows immediately from this.

In what follows, we shall omit the proof of all the statements in which we (implicitly) claim that $\{B_1(0), H_\theta^{-1}(B_1(\theta))\}$ is a (p, q) -separating sequence. The reason is that the required arguments are very similar to the one given right above.

Suppose now that $0 \in \Sigma_1(X, p, q)$. Let $\beta_1, \beta_2, \dots, \beta_l$, be the blocks of $([F_p, F_q], \gamma)$ ordered in the natural way, with $T_0 \in \beta_1$. ■

It follows from Proposition 4.1 that β_1 is of one of the following subtypes: $(T, \cup, \dots, \cup, T)$, $(T, \cup, \dots, \cap, T)$, $(T, \cup, \dots, \cap]$ and $(T, \cup, \dots, \cup]$. By Lemma 4.3, β_1 cannot be of type $(T, C, \dots, C]$. If β_1 is of subtype $(T, \cup, \dots, \cup, T)$ then (by Statement 4.1,4 of Proposition 4.1 and Lemma 2.5,(d)) we may see that the lemma is true. If β_1 is of subtype $(T, \cup, \dots, \cap, T)$ then, by Proposition 2.1, the second block β_2 must be either of type (T, \cup, \dots, C, T) or of type $(T, \cup, \dots, C]$, where $C \in \{\cap, \cup\}$.

We claim that β_2 cannot be of type $(T, \cup, \dots, \cup]$. Otherwise, if we denote by $\beta_i(\theta)$, with $i \in \{1, 2\}$ and $\beta_i(0) = \beta_i$, the “block” of $([F_p(\theta), F_q(\theta)], \lambda_\theta)$ emerging from β_i , as θ varies, in the sense of Statements 4.1,2 and 4.1,12, of Proposition 4.1, we will have that, for $\theta > 0$ small, $\beta_1(\theta) = (T, T, T)$ and $\beta_2(\theta) = (T, T]$ are both part of transversal regions of $[F_p(\theta), F_q(\theta)]$. By the type of β_2 , the only blocks of $([F_p, F_q], \gamma)$ are precisely β_1 and β_2 and therefore $\beta_1(\theta)$ and $\beta_2(\theta)$, for θ small, have to form all the blocks of $([F_p(\theta), F_q(\theta)], \lambda_\theta)$. This implies that $([F_p(\theta), F_q(\theta)], \lambda_\theta)$ will have only one transversal region. This contradiction with Lemma 4.3 proves our claim.

In a similar way (see Statement 4.1,10 of Proposition 4.1), β_2 cannot be of type $(T, \cup, \dots, \cap]$ and so β_2 is either of type $(T, \cup, \dots, \cup, T)$ or of type $(T, \cup, \dots, \cap, T)$. If β_2 is of type $(T, \cup, \dots, \cup, T)$, then the lemma is true. If β_2 is of type $(T, \cup, \dots, \cap, T)$, then we shall proceed to study the third block and so on. As there can be only finitely many blocks and by the same argument used above to show that β_2 cannot be of type $(T, \cup, \dots, \cup, T]$, we conclude that all blocks β_i cannot be of type $(T, \cup, \dots, \cap, T)$. Hence, we shall eventually find a sequence of consecutive blocks $\beta_1, \beta_2, \dots, \beta_m$ of type $(T, \cup, \dots, \cap, T)$ such that β_{m+1} is of type $(T, \cup, \dots, \cup, T)$. Under these conditions and by an argument similar to the case above the lemma follows. □

LEMMA 5.2. – *Suppose that, for some $\theta \in (-\varepsilon, 0)$, $D_1(\theta)$ is on the right of λ_θ (resp. on the left of λ_θ). If $\varepsilon > 0$ is small enough then, for all $\theta \in (-\varepsilon, 0]$, $D_1(\theta)$ is on the right of λ_θ (resp. on the left of λ_θ) and $0 \geq \theta > -\varepsilon$ (resp. $0 \leq \theta < \varepsilon$) implies that $\{H_\theta^{-1}(B_1(\theta)), B_1(0)\}$ is a (p, q) -separating sequence.*

Proof. – If $0 \in \Sigma(X, p, q)$, then the proof is similar to that of Lemma 5.1 and will be omitted.

Suppose that $0 \in \Sigma_1(X, p, q)$. We shall only consider the case in which for some $\theta \in (-\varepsilon, 0)$, $D_1(\theta)$ is on the right of λ_θ . If $\varepsilon > 0$ is small enough, it follows from Corollary 4.8 that, for all $\theta \in (-\varepsilon, 0)$, $\theta \in \Sigma(X, p, q)$. Therefore, using Proposition 3.1 and the same arguments as that of the beginning of the proof of Lemma 5.1,

(1) for all $\theta \in (-\varepsilon, 0)$, $D_1(\theta)$ is on the right of λ_θ .

Let $\beta_1, \beta_2, \dots, \beta_l$, be the blocks of $([F_p, F_q], \gamma)$ ordered in the natural way, with $T_0 \in \beta_1$. Take $\varepsilon > 0$ so small that all the Statements 4.1,1-4.1,12 are true when are to be applied to the blocks β_k . It follows from Proposition 4.1 that if a half-Reeb component C_i of $([F_p, F_q], \gamma)$ persists when $\theta \in (-\varepsilon, 0]$ varies, then

(2.1) λ_θ restricted to $[L_i(\theta), R_i(\theta)]$ coincides with $H_\theta \circ \gamma$ and the persisting half-Reeb component $C_i(\theta)$ of $([F_p(\theta), F_q(\theta)], \lambda_\theta)$ is precisely the one given by one of the Statements 4.1,1-4.1,12 of the proposition.

(2.2) Every half-Reeb component of $([F_p(\theta), F_q(\theta)], \lambda_\theta)$ is of the form $C_i(\theta)$ as described in (2.1).

Hence, there exists $1 \leq j \leq n$ such that, for all $\theta \in (-\varepsilon, 0]$, $C_j(\theta) = D_1(\theta)$. In particular

(3) C_j is on the right of γ and belongs to a block β_i of one of the following subtypes: $(T, \cup, \dots, \cup, T)$, $(T, \cup, \dots, \cap, T)$, $(T, \cup, \dots, \cap]$ and $(T, \cup, \dots, \cup]$.

Denote by $\beta_i(\theta)$, with $\beta_i(0) = \beta_i$, the “block” of $([F_p(\theta), F_q(\theta)], \lambda_\theta)$ emerging from β_i , as θ varies, in the sense of Statements 4.1,1-4.1,12 of Proposition 4.1 (for instance, if $\beta_i = (T, \cap, \dots, \cup, T)$ is as in Statement 4.1,1, then, for all $\theta < 0$, $\beta_i(\theta) = (T, T, T)$ and, for $\theta > 0$, $\beta_i(\theta) = (T, \cap, T, \cup, T)$).

We claim that $i = 1$. If we assume by contradiction that $i > 1$, then, by (2.1) and (2.2), we will have that $\beta_{i-1}(\theta)$, with $\theta \in (-\varepsilon, 0)$, must be formed by transversal regions only. Therefore, by analyzing the Statements 4.1,1-4.1,12 of Proposition 4.1, β_{i-1} can only be of one of the following types:

$$(T, \cap, \dots, \cup, T), \quad [\cap, \dots, \cup, T) \quad \text{and} \quad [\cup, \dots, \cup, T).$$

However, if we put together β_{i-1} and β_i we shall obtain a contradiction with Proposition 2.1 (see (3)). This proves that $\beta_i = \beta_1$.

Under these conditions, we conclude from (3) and from Lemma 4.3 that

(4) β_1 is either of type $(T, \cup, \dots, \cup, T)$ or $(T, \cup, \dots, \cap, T)$.

Hence, it follows from Statements 4.1,2 and 4.1,4 of Proposition 4.1 that not only $C_j = C_1$ but also that the arguments of Lemma 5.1 can be used to finish the proof of this lemma. \square

End of the proof of Theorem A. – Consider only the case in which C_1 is on the right. Let $[0, \varphi)$ be the maximal subinterval of \mathfrak{R} such that if $0 \leq \theta < \varphi$ then $\{B_1(0), H_\theta^{-1}(B_1(\theta))\}$ is a (p, q) -separating sequence. It follows from Lemmas 5.1 and 5.2 and standard arguments based on the connectedness and compactness of closed intervals that $\varphi = \infty$. More precisely, given an interval $[0, b]$, by its compactness and by Lemmas 5.1 and 5.2, there exists a finite sequence $0 = \theta_0 < \theta_1 < \dots < \theta_{l-1} < \theta_l = b$ such that, for all $i \in \{0, 1, \dots, l-1\}$,

$$\{B_1(\theta_i), (H_{\theta_{i+1}-\theta_i})^{-1}(B_1(\theta_{i+1}))\}$$

is a $(H_{\theta_i}(p), H_{\theta_i}(q))$ -separating sequence. Considering the cases $i \in \{0, 1\}$, this implies that

$$\{B_1(0), H_{\theta_1}^{-1}(B_1(\theta_1)), H_{\theta_2}^{-1}(B_1(\theta_2))\}$$

is a (p, q) -separating sequence. By induction,

$$\{B_1(0), H_{\theta_1}^{-1}(B_1(\theta_1)), \dots, H_{\theta_l}^{-1}(B_1(\theta_l))\}$$

is a (p, q) -separating sequence. In particular,

$$\{B_1(0), H_{\theta_l}^{-1}(B_1(\theta_l))\}$$

is a (p, q) -separating sequence. This proves that $\varphi = \infty$.

However, this is a contradiction because $H_{2\pi}$ is the identity map and so $\{B_1(0), H_{2\pi}^{-1}(B_1(2\pi)) = B_1(0)\}$ cannot be a (p, q) -separating sequence.

REFERENCES

- [1] M. A. AIZERMAN, On a problem concerning the stability in the large of dynamical systems., *Uspehi Mat. Nauk. N. S.*, Vol. 4, (4), pp. 187-188.
- [2] N. E. BARABANOV, On a problem of Kalman., *Siberian Mathematical Journal*, Vol. 29, (3), 1988, pp. 333-341.
- [3] R. FESSLER, *A solution of the two dimensional Global Asymptotic Jacobian Stability Conjecture*, Preprint. ETH-Zentrum, Switzerland.
- [4] A. GASULL, J. LLIBRE and J. SOTOMAYOR, Global asymptotic stability of differential equations in the plane, *J. diff. Eq.*, 1989, To appear.
- [5] A. GASULL and J. SOTOMAYOR, On the basin of attraction of dissipative planar vector fields, *Lecture Notes in Mathematics*. Springer-Verlag. Procc. Coll. Periodic Orbits and Bifurcations. Luminy, 1989, To appear.

- [6] G. GORNI and G. ZAMPIERI, *On the global conjecture for global asymptotic stability*, 1990, To appear.
- [7] C. GUTIERREZ, Dissipative vector fields on the plane with infinitely many attracting hyperbolic singularities, *Bol. Soc. Bras. Mat.*, Vol. 22, No. 2, 1992, pp. 179-190.
- [8] P. HARTMAN, On stability in the large for systems of ordinary differential equations, *Can. J. Math.*, Vol. 13, 1961, pp. 480-492.
- [9] P. HARTMAN, *Ordinary differential equations*, Sec. Ed. Birkhäuser, 1982.
- [10] R. E. KALMAN, On Physical and Mathematical mechanisms of instability in nonlinear automatic control systems, *Journal of Applied Mechanics Transactions, ASME*, Vol. 79, (3), 1957, pp. 553-566.
- [11] N. N. KRASOVSKII, Some problems of the stability theory of motion, 1959, In russian. *Gosudartv Izdat. Fiz. Math. Lit.*, Moscow., English translation, Stanford University Press, 1963.
- [12] L. MARKUS and H. YAMABE, Global stability criteria for differential systems, *Osaka Math. J.*, Vol. 12, 1960, pp. 305-317.
- [13] G. MEISTERS and O. OLECH, Global Stability, injectivity and the Jacobian Conjecture, To appear in *the Procc. of the First World Congress on Nonlinear Analysis held at Tampa, Florida*. August, 1992.
- [14] G. MEISTERS and O. OLECH, Solution of the global asymptotic stability Jacobian conjecture for the polynomial case, *Analyse Mathématique et applications. Contributions en l'honneur de J. L. Lions.*, Gauthier-Villars, Paris, 1988, pp. 373-381.
- [15] C. OLECH, On the global stability of an autonomous system on the plane, *Cont. to Diff. Eq.*, Vol. 1, 1963, pp. 389-400.
- [16] B. SMITH and F. XAVIER, Injectivity of local diffeomorphisms from nearly spectral conditions, University of Notre Dame, *Preprint*, 1993.

*(Manuscript received April 26, 1993;
revised May, 1994.)*